



ENGINE GASKET SETS
JUNTAS DE MOTOR







Tractors Tractores	Engine Motor	1 Top gasket set Juego de jun. sup.	2 Bottom gasket set Juego de jun. inf.	3 Cyl head gasket Junta culata	4 Rocker cover gasket Junta tapa de balacín	5 Sump gasket Junta de cárter
4 cylinder engine industrial tractors / Palas retrocargadoras motores 4 cilindros						
702	23C Diesel	30/71-2 (1810028M91)	30/72-2 (1810027M91)	30/73-2 (1882771M1)	30/74-4 (826194M1)	30/75-111 (3910274M1)
356	A4.203	30/71-7 (U5LT0509, 4222455M91)	30/72-6 (U5LB0502, 4223525M91)	30/73-7 (36812141, 4222122M1)	30/74-6 (0490704, 731164M1)	30/75-108 (E) (41424238, 4224063M91)
30, 40B, 50, 302, 304, 356, 3165, 3303, 3305 (⇒ 29C1083) Ropa seal / Roda de cuerdas	AD4.203	30/71-8 (U5LT0100, 4222920M91)	30/72-9 (U5LB1117, 4223940M91)	30/73-8 (3681E023, 3641182M1)	30/74-9 (36811112, 732821M1)	30/75-109 (E) (41424239, 21826401, 4222934M1, 4224379M1)
30, 40B, 50, 302, 304, 356, 3165, 3303, 3305 (29C1084 ⇒) Lip seal / Roda de labios	AD4.203					
50, 50B, 3303, 3305	A4.212					
30D, 50, 50B, 50B MKII, 50C, 50D, 50E, 50H, 60 Early blocks 103.19mm bore Ø Primeros bloques 103.19mm dia Ø	A4.236	30/71-10 (U5LT1014, 4224186M91)		30/73-11 (3681E021, 3638845M1)		
30D, 50, 50B, 50B MKII, 50C, 50D, 50E, 50H, 50H-S, 50H-T, 60 Later blocks 104.20mm bore Ø Últimos bloques 104.20mm dia Ø	A4.236	30/71-52 (U5LT1004, 4224189M91)	30/72-10 (U5LB0145, 3640719M1)	30/73-52 (3681E036, 4222500M1)	30/74-11 (3681A027, 3638482M1)	30/75-106 (3681K003, 3641273M1)
60HX, 60HX-T	AT4.236	30/71-53 (U5LT1006, 4224246M91)		30/73-53 (3681E034, 4222124M1)		
50EX, 50HX, 60H With flame ring Con segmentos cortifuegos	A4.248	30/71-10 (U5LT1014, 4224186M91)		30/73-11 (3681E021, 3638845M1)		
50EX, 50HX, 60H 50HX-S, 50HX-T, 60HS Without flame ring Sin segmentos cortifuegos	A4.248	30/71-52 (U5LT1004, 4224189M91)		30/73-52 (3681E036, 4222500M1)		
70	A4.318	30/71-31 (U5LT0520, 4223502M91)	30/72-31 (U5LB0221, 4223129M91)	30/73-31 (36812348, 745730M1)	30/74-13 (3681A008, 746036M1)	30/75-121 (21826314, 4223002M1)
Ferrec & Terex - 4 cylinder engine industrial tractors / Palas retrocargadoras motores 4 cilindros						
750	1004.4 (Blue)	30/71-90 (U5LT1178, U5LT1196, 4224621M91, 4224623M91)	30/72-113 (U5LB1160, 4224457M91)	30/73-90 (3681E037, 4224501M1)	30/74-105 (3681A032, 3641891M1)	
760, 860, 860S, 860SE, 865, 960, 965	1004.4T (Blue)					30/75-106 (3681K003, 3641273M1)
750, 750B	1004.42 (Green)			30/73-83 (3681E042, 4223146M1)	30/74-108 (3681A049, 4224452M91)	
760, 760B, 860, 860B, 860S, 860SE, 960, 960B, 965	1004.40T (Green)	30/71-82 (U5LT1202, 4224635M91)	30/72-113 (U5LB1160, 4224457M91)	30/73-90 (3681E037, 4224501M1)		

(E) Sump gasket is supplied complete with rear cork joint / La junta de cárter se sirve con la junta de corcho trasera

Part numbers are quoted for reference purposes only.
Our parts and accessories are not original.

Las referencias originales tienen un símbolo identificativo.
Nuestras piezas no son originales.









LOCTITE® LOCTITE®			
Ref. Ref.	Fig. Fig.	Description Descripción	OEM OEM
Thread fixing / Fijador de roscas			
78/9604-101 50 ml		<p>Loctite 243</p> <p>Effective on all types of metal threaded fasteners. Prevents loosening on vibrating parts such as pumps, motor mounting bolts, gear boxes or presses. Recommended for use where disassembly with hand tools is required for servicing and where parts are contaminated with oil.</p>	1810590M1, 3405351M1
78/9604-103 10 ml		<p><i>Eficaz en piezas con rosca metálica. Previene que las piezas roscadas se aflojen por vibraciones, como tornillos de bombas, motores, cajas de cambio o embragues. Recomendado para piezas de desmontaje con herramienta manual y aquellas inmersas en ambientes lubricados.</i></p>	3930904M1, 1633266M1, 3405350M1
78/9604-102 50 ml		<p>Loctite 271</p> <p>For use on all metal fasteners (including stainless steels and those with protective coatings such as zinc) where regular removal for maintenance is not required. Recommended for permanently locking studs on engine blocks and pump housings.</p>	3303219M1, 1810581M1, 1810589M1, 3405353M1, 3405352M1, 3405352M5, 3930908M1
Hydraulic sealant / Sellador hidráulico			
78/9604-121 50 ml		<p>Loctite 542</p> <p>Recommended for fine threaded fittings as used in hydraulic and pneumatic installations, for connections on machine tools, automotive vehicles, heavy plant equipment and small fittings in general.</p>	3304296M1
Blocoprese / Retenedor			
78/9604-110 50 ml		<p>Loctite 603</p> <p>For retaining close fitting cylindrical parts (up to 0.1 mm gap). For use on cylindrical fitting parts where thorough degreasing is not possible.</p>	3303220M1
78/9604-113 50 ml		<p>Loctite 648</p> <p>Recommended for retaining parts with a clearance or interference fit, i.e. retaining bushes, bearings, seals, fans, and liners.</p>	892054M1, 1633268M1

Part numbers are quoted for reference purposes only.
Our parts and accessories are not original.

Las referencias originales tienen un propósito identificativo.
Nuestras piezas no son originales.



LOCTITE®
LOCTITE®

Ref. Ref.	Fig. Fig.	Description Descripción	OEM OEM
Thread fixing / Formador de juntas			
78/9604-130 50 ml		Loctite 510 Recommended for gasketing rigid surface on pumps, sleeves, gear box and housings. Loctite® 510 is thixotropic and can be set less running on vertical surface. <i>Recomendado para formar juntas sobre superficies rígidas bombas, cajas de cambio y carcasas. Loctite 510 es tixotropo y puede ser aplicado sobre superficies verticales evitando el goteo.</i>	982580M2, 982211M1, 975008M1, 982041M2, 3930274M92, 3900613M2, 1610311M2, 1610449M2, 1610378M1, 1633270M2, 1617849M1, 1610240M1, 1612487M1, 1610613M1, 1633270M3, 1425202M1, 1425422M1, 1425466M1, 1425200M1, 1426565M1, 1423566M1, 1425199M1, 1425197M1, 1425178M1, 1825006M1, 1819877M1, 1821823M1, 1823590M1, 1870869M2, 1825353M1, 1824661M1, 1823648M1
78/9604-143 50 ml		Loctite 5926 Silicone Blue RTV. Permanently flexible silicone rubber sealant for gasketing flanges in any size and shape. Sets very quickly. Ideal for a wide range of automotive applications. <i>Silicona RTV azul. Silicona flexible y permanente para preparar juntas de toda forma y tamaño. Secado rápido. Ideal para una amplia gama de aplicaciones agrícolas y automoción.</i>	1642923M1
78/9604-139 300 ml		Loctite 5699 Silicone paste of strong viscosity and high mechanic resistance. <i>Pasta de silicona gris de fuerte viscosidad y gran resistencia mecánica.</i>	
78/9604-140 300 ml		Loctite 5910 Replacement for cork and paper cut gaskets on flanges and stamped sheet metal covers. <i>Sustituye las juntas de papel y corcho para tapas de metal estampado.</i>	
Limé / Adhesivos			
78/9604-150 (20g)		Loctite 401 General purpose for bonding most substrates such as plastics, rubber, paper/card, wood and metals. <i>Adhesivo de uso universal para pegar la mayoría de materiales, tales como plástico, goma, papel, cartón, madera y metales.</i>	3405356M1
Cleaning / Limpieza			
78/9604-221 3 Ltr.		Loctite 7850 Natural hand cleaner made from citrus extracts and free from mineral oil. Contains premium skin conditioners. Biodegradable. Works with or without water. <i>Jabón de manos natural a base de extractos de cítricos y otros protectores de la piel, libre de aceites minerales. Biodegradable. Se puede usar con y sin agua. Retira las grasas, breas, colas, pinturas y otras suciedades.</i>	3930906M1

Part numbers are quoted for reference purposes only.
Our parts and accessories are not original.

Las referencias originales tienen un pequeño identificador.
Nuestras piezas no son originales.



TIMING GEAR DISTRIBUCIÓN

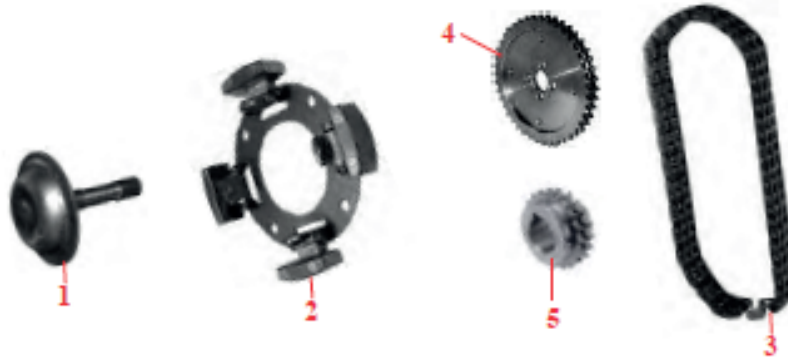

Tractors <i>Tractores</i>	Engine <i>Motor</i>	1 Cap & shaft assy. <i>Tapa con eje</i>	2 Governor weight assy. <i>Regulador</i>	3 Timing chain <i>Cadena de distribución</i>	4 Camshaft sprocket <i>Engranaje de árbol de levas</i>	5 Crankshaft gear <i>Engranaje cigüeñal</i>
4 cylinder engines / Motores 4 cilindros						
TEA20 TED20 TEH20 35, 135	85mm Petrol 85mm VO 85mm LO 87mm Petrol	30/6690-1 (825157M91)	30/6689-1 (825890M91)	30/6691-1 (825199M1)	30/81-4 (825135M1)	30/12-17 (825136M1)
TEF20	20C Diesel			30/6691-4 (61471)		
FE35, 835 702 (Industrial/ Industrial)	23C Diesel			30/6691-5 (826094M1)		

Tractors <i>Tractores</i>	Engine <i>Motor</i>	Ref. <i>Ref.</i>	Fig.	OEM	Description <i>Descripción</i>
4 cylinder engines / Motores 4 cilindros					
TEA20 TED20 TEH20 35, 135	85mm Petrol 85mm VO 85mm LO 87mm Petrol	30/980-1	6	408335, 829927M1	Rotor arm <i>Rotor</i>
		30/981-1	7	423153	Contact set <i>Platinos</i>
		30/982-1	8	407044, 829924M1, 1750451M1	Condenser <i>Condensador</i>
		30/983-1	9	829937M1, 1714844M1	Distributor cap <i>Tapa del "Delco"</i>
		30/984-1	10	570062M3	Ignition coil <i>Bobina de encendido</i>



Tractors <i>Tractores</i>	Engine <i>Motor</i>	Timing gear <i>Tapa de distribución</i>
35, 133, 135	A3.144	
35	A3.152	
133, 134, 135, 140, 145, 148, 150, 152, 154, 230, 233, 234, 235, 240, 244CF, 245, 250, 253 (Italy), 254, 255, 335, 334V, 340, 342, 350, 353, 354, 356CF, 550, 2205, 3210	AD3.152	30/79-1 (ZZ90039, 3637397M91)
164T, 253 (UK), 263T, 264T, 352, 355, 360, 363, 364, 366CF	AT3.152.4	

Part numbers are quoted for reference purposes only.
Our parts and accessories are not original.

Las referencias originales tienen un propósito identificativo.
Nuestras piezas no son originales.



TIMING GEAR DISTRIBUCIÓN

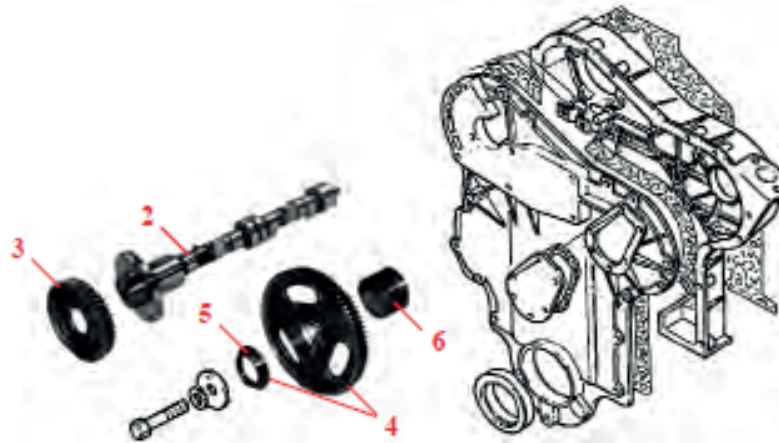

Tractors <i>Tractores</i>	Engine <i>Motor</i>	1 Camshaft bush <i>Carg. árbol de levas</i>	2 Camshaft <i>Árbol de levas</i>	3 Camshaft gear <i>Engranaje</i>	4 Idler gear <i>Engranaje</i>	5 Idler gear bush <i>Canchillo</i>	6 Idler hub <i>Españador</i>
3 cylinder engines / Motores 3 cilindros							
35, 133, 135	A3.144						
35	A3.152						
135	AG3.152						
133, 134, 135, 140, 145, 148, 150, 152, 154, 230, 233, 234, 235, 240, 244CF, 245, 250, 253 (Italy), 254, 255, 333, 340, 353, 356CF, 550 334V (CE31218)	AD3.152		30/80-1 (31415261, 733507M1)	30/81-1 (3116K111, 4224245M1)	30/82-1 (31164362, 731205M2)		
354, 3210 (CE31197)							
334V (CE31213)							
354, 3210 (CE31212)	AD3.152			30/81-13 (3117F081, 4222611M1)	30/82-13 (4111A015, 3638219M91)	30/84-7 (2511A735, 3637942M1)	
342, 350, 2205							
164T, 253 (UK), 263T (Italy), 264T	AT3.152.4			30/81-1 (3116K111, 4224245M1)	30/82-1 (31164362, 731205M2)		30/83-3 (0995447, 731204M1)
363, 364, 366CF (CN31198 ⇨ U998665D)							
352	AT3.152.4		30/80-6 (31415264, 3637539M1)	Cast iron / <i>Fundición</i> 30/81-1 (3116K111, 4224245M1) <i>Steel / Acero</i> 30/81-13 (3117F081, 4222611M1)			
355, 360							
363, 364, 366CF (CN31198 U998666D ⇨)	AT3.152.4				30/82-13 (4111A015, 3638219M91)	30/84-7 (2511A735, 3637942M1)	
364 (CN31225)							
2210, 3315, 4215, 4315	903.27			30/81-13 (3117F081, 4222611M1)			
263 (UK), 2220, 3325, 4220, 4320	903.27T						

Part numbers are quoted for reference purposes only.
Our parts and accessories are not original.

Las referencias originales tienen un propósito identificativo.
Nuestras piezas no son originales.



TIMING GEAR DISTRIBUCIÓN

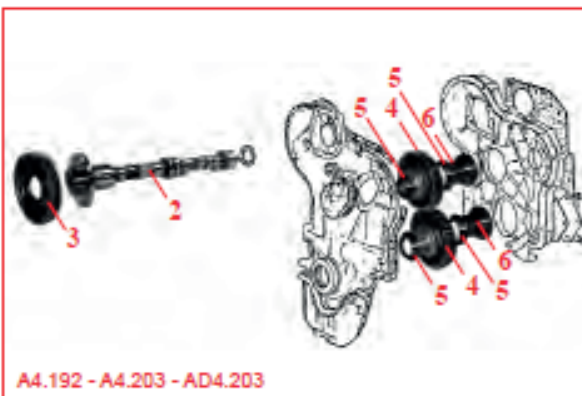

A4.192 - A4.203 - AD4.203

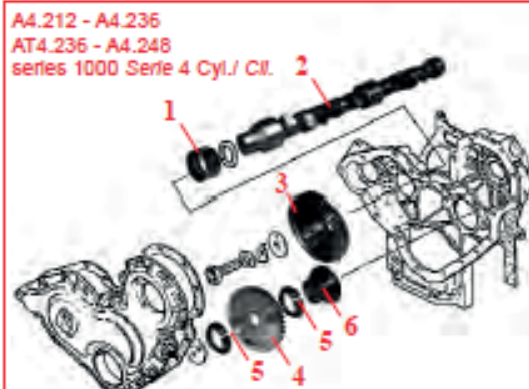

A4.212 - A4.236
AT4.236 - A4.248
series 1000 Serie 4 Cyl./ Cil.

Tractor Tractor	Engine Motor	1 Camshaft bush Carg. árbol de Levas	2 Camshaft Árbol de Levas	3 Camshaft gear Engranaje	4 Idler gear Engranaje	5 Idler gear bush Carguillo	6 Idler hub Españador
4 cylinder engines / Motores 4 cilindros							
65	A4.192				Sup. / Sup. 30/82-2 (0410227, 731034M1)	Sup. / Sup.	
65, 865	A4.203				Inf. / Inf. 30/82-3 (0994946, 731628M91)	Inf. / Inf. 30/84-8 (0050345, 731033M1)	
65, 155, 158, 165, 765 (⇒ UAS4217D)	AD4.203			30/81-2 (0410231, 731028M1)	Sup. / Sup. 30/82-15 (41115005, 740865M91)		
65, 155, 158, 165, 765 (UA84218D ⇒)	AD4.203				Inf. / Inf. 30/82-3 (0994946, 731628M91)		
158MKIII, 260, 560							
165, 174	A4.212			⇒ U106654N 30/81-3 (31171353, 736254M1)	30/82-4 (41115023, 734738M91)		30/83-1 (33426161, 735852M1)
168, 168MKIII, 174, 175, 184, 255 (USA), 265, 273, 274, 275, 283, 284, 565, 575, 675	A4.236		⇒ U106654N 30/80-4 (A) (31415321, 736818M1)	U106655N ⇒ 30/81-14 (3117L012, 3641740M1)		30/84-8 (0050345, 731033M1)	
362, 362N, 365, 372N, 375	A4.236	30/56-1 (31134165, 4222017M1)	U106655N ⇒ 30/80-7 (B) (31415375, 3641841M91)	⇒ U106654N 30/81-10 (31171138, 3637421M1)	⇒ U171963P 30/82-12 (4111A013, 3637075M91)		
275E, 367CF, 373, 374, 375E, 376C, 377, 383, 387, 3050, 3220, 3225	A4.236		30/80-7 (31415375, 3641841M91)	30/81-14 (3117L012, 3641740M1)	U171964P ⇒ 30/82-14 (4111A016, 3638220M91)		

(A) Fast lift camshaft lobes / Levas del árbol "agudas"
(B) Slow lift camshaft lobes / Levas del árbol "romas"

Part numbers are quoted for reference purposes only.
Our parts and accessories are not original.

Las referencias originales tienen un propósito identificativo.
Nuestras piezas no son originales.



**TIMING GEAR
DISTRIBUCIÓN**

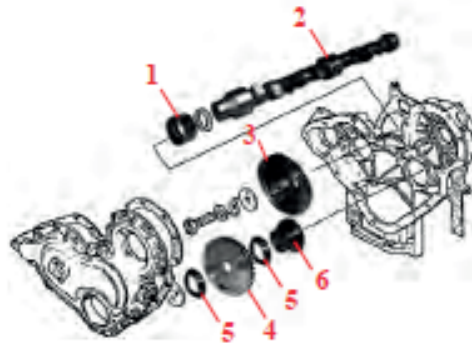

		1	2	3	4	5	6
Tractors Tractores	Engine Motor	Camshaft bush Carg. Carg. árbol de levas	Camshaft Árbol de levas	Camshaft gear Engranaje	Idler gear Engranaje	Idler gear bush Carguillo	Idler hub Espaciador
4 cylinder engines / Motores 4 cilindros							
390T, 398	AT4.236		30/80-13 (31415384, 3641843M91)	30/81-12 (3117L023, 3641739M1)	⇒ U171963P 30/82-12 (4111A013, 3637075M91) U171964P ⇒ 30/82-14 (4111A016, 3638220M91)		
393TLX, 394TAQ, 396CT, 397T, 698T, 1004T, 3065, 3065S, 3070	AT4.236		⇒ U083371N U083372N ⇒ 30/80-13 (B) (31415384, 3641843M91)	⇒ U083371N 30/81-3 (31171353, 736254M1) U083372N ⇒ 30/81-14 (3117L012, 3641740M1)		30/82-12 (4111A013, 3637075M91)	
1007	AT4.236	30/56-1 (31134165, 4222017M1)	30/80-13 (31415384, 3641843M91)	30/81-14 (3117L012, 3641740M1)		30/84-8 (0050345, 731033M1)	30/83-1 (33426161, 735852M1)
178, 185, 188, 194, 285, 290, 293, 294, 390, 690, 3055, 3060	A4.248		⇒ U108196N 30/80-4 (A) (31415321, 736818M1) U108197N ⇒ 30/80-7 (B) (31415375, 3641841M91)	⇒ U108196N 30/81-3 (31171353, 736254M1) U108197N ⇒ 30/81-14 (3117L012, 3641740M1)		30/82-4 (41115023, 734738M91)	
290E, 390E, 393, 394, 396C, 397, 3235	A4.248			30/81-14 (3117L012, 3641740M1)			
382N, 390	A4.248		30/80-7 (31415375, 3641841M91)	30/81-12 (3117L023, 3641739M1)	⇒ U171963P 30/82-12 (4111A013, 3637075M91) U171964P ⇒ 30/82-14 (4111A016, 3638220M91)		

(A) Fast lift camshaft lobes / Levas del árbol "agudas"
(B) Slow lift camshaft lobes / Levas del árbol "romas"

Part numbers are quoted for reference purposes only.
Our parts and accessories are not original.

Las referencias originales tienen un propósito identificativo.
Nuestras piezas no son originales.



**TIMING GEAR
DISTRIBUCIÓN**

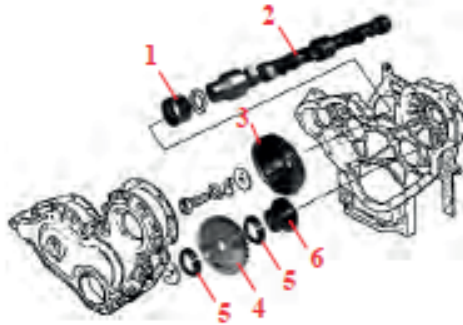

Tractors <i>Tractores</i>	Engine <i>Motor</i>	1 Camshaft bush <i>Carg. árbol de levas</i>	2 Camshaft <i>Árbol de levas</i>	3 Camshaft gear <i>Engranaje</i>	4 Idler gear <i>Engranaje</i>	5 Idler gear bush <i>Carguillo</i>	6 Idler hub <i>Espaciador</i>
4 cylinder engines / Motores 4 cilindros							
275E, 290E, 375E, 390E	A4.41	30/56-1 (31134165, 4222017M1)	30/80-12 (31415363, 3641840M91)	30/81-14 (3117L012, 3641740M1)	30/82-14 (4111A016, 3638220M91)	30/84-8 (0050345, 731033M1)	30/83-1 (33426161, 735852M1)
4225, 4235, 4240, 6110, 6120	A4.41 (Blue)				30/82-4 (41115023, 734738M91)		
3075, 6130, 6140, 6150	1004.4T				30/82-12 (4111A013, 3637075M91)		
4245, 4255	1004.4T (Blue)			30/81-12 (3117L023, 3641739M1)	30/82-14 (4111A016, 3638220M91)		
374, 3220, 3330	1004.40 (Green)				30/82-12 (4111A013, 3637075M91)		
3350, 3355	1004.40T			30/81-14 (3117L012, 3641740M1)	30/82-14 (4111A016, 3638220M91)		
4225, 4325	1004.40 (Green)						
4235, 4245, 4345, 6235, 6245	1004.40T (Green)			30/81-12 (3117L023, 3641739M1)	30/82-12 (4111A013, 3637075M91)		
4255, 4355, 6255	1004.40T (Green)						
4265, 4365, 6265	1004.40TW (Green)			30/82-14 (4111A016, 3638220M91)	30/82-12 (4111A013, 3637075M91)		
394, 2230, 3235, 3340	1004.42 (Green)						
4235 (USA), 4335	1004.42 (Green)				30/82-14 (4111A016, 3638220M91)		

Part numbers are quoted for reference purposes only.
Our parts and accessories are not original.

Las referencias originales tienen un propósito identificativo.
Nuestras piezas no son originales.



**TIMING GEAR
DISTRIBUCIÓN**

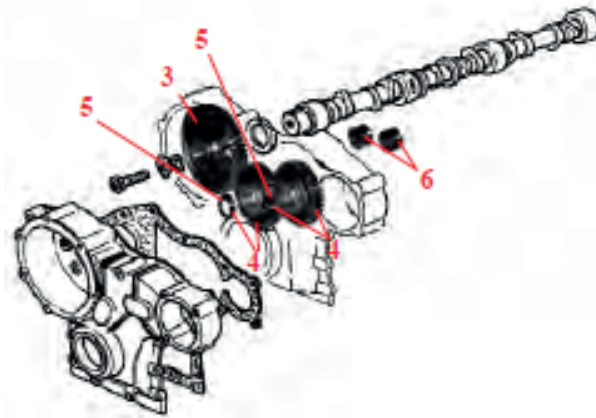

		3	4	5	6
Tractor Tractor	Engine Motor	Camshaft gear Engranaje	Idler gear Engranaje	Idler gear bush Casquillo	Idler hub Espaciador
6 cylinder engines / Motores 6 cilindros					
1100 1014, 1104, 1200	A6.354 A6.354.1	30/81-3 (31171353, 736254M1)		30/84-10 (31134121, 733733M1)	
1014 (TW31087 ⇒ U725809L) 2620, 2625, 2675	A6.354.4		LH / Izda. 30/82-11 (41115056, 741263M91)		
399, 699 1014 (TW31087 U725810L ⇒) 1014 (TW31147), 1024, 1114, 1250, 2640, 2645, 3080, 3090, 3610	A6.354.4	30/81-10 (31171138, 3637421M1)	RH / Dcha. 30/82-10 (41115057, 741266M91)	30/84-9 (2511613, 741265M1)	30/83-2 (32718522, 741262M1)
1130	AT6.354				
1105 1135	ATC6.354.1 AT6.354.1			30/84-10 (31134121, 733733M1)	
2680, 2685	AT6.354.4	30/81-3 (31171353, 736254M1)	LH / Izda. 30/82-11 (41115056, 741263M91)	30/84-9 (2511613, 741265M1)	30/83-2 (32718522, 741262M1)
1134, 2705, 2720, 2725, 3630, 3650	AT6.354.4	30/81-10 (31171138, 3637421M1)	RH / Dcha. 30/82-10 (41115057, 741266M91)		

Part numbers are quoted for reference purposes only.
Our parts and accessories are not original.

Las referencias originales tienen un propósito identificativo.
Nuestras piezas no son originales.



**TIMING GEAR
DISTRIBUCIÓN**

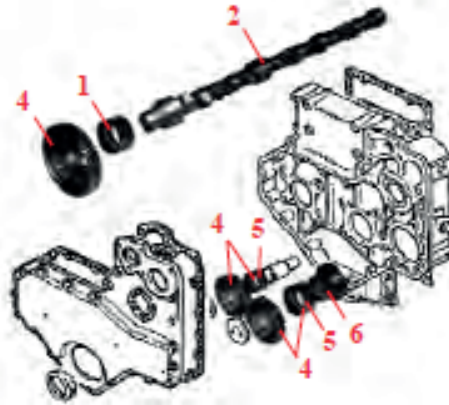

Tractors Tractores	Engine Motor	1 Camshaft bush Carg. árbol de levas	2 Camshaft Árbol de levas	3 Camshaft gear Engranaje	4 Idler gear Engranaje	5 Idler gear bush Carguillo	6 Idler hub Espaciador
6 cylinder engines / Motores 6 cilindros							
396, 399, 3085, 3095, 3115, 4260, 4270, 6160, 6170	1006.6 (Blue)	30/56-1 (31134165, 4222017M1)	30/80-11 (31416307, 3641738M1)	30/81-12 (3117L023, 3641739M1)	LH / Izda. 63 <i>tooth / Dientes</i>	LH / Izda. 30/84-8 (0050345, 731033M1)	LH / Izda. 30/83-1 (33426161, 735852M1)
3120, 3120T, 3125, 3140, 3635 (YB31245), 6180	1006.6T (Blue)			30/81-14 (3117L012, 3641740M1)	30/82-12 (4111A013, 3637075M91)		
3635 (YB31262), 3645, 3655, 3660, 6190, 8110, 8120, 8130	1006.6T (Blue)			30/81-12 (3117L023, 3641739M1)	RH / Drccha. 27 <i>tooth / Dientes</i>	RH / Drccha. 30/84-11 (2511437, 1447752M1)	
4260, 4360, 6260	1006.60 (Green)				30/82-16 (4111A008, 748072M91)		
4270, 4370, 6170, 6180, 6270, 6280, 6290, 8120, 8210, 8220	1006.60T (Green)						

**LOWER TIMING GEAR HOUSING SUPPORT
SOPORTE INFERIOR DE DISTRIBUCIÓN**

35, 133, 135	A3.144	30/6079-1 (37354312, 731214M1)
35	A3.152	
133, 134, 135, 140, 145, 148, 150, 152, 154, 230, 233, 234, 235, 240, 244CF, 245, 250, 253 (Italy), 254, 255, 333, 334V, 340, 342, 350, 353, 354, 356CF, 550, 2205, 3210	AD3.152	
164T, 253 (UK), 263T, 264T, 352, 355, 360, 363, 364, 366CF	AT3.152.4	



Part numbers are quoted for reference purposes only.
Our parts and accessories are not original.

Las referencias originales tienen un propósito identificativo.
Nuestras piezas no son originales.



**TIMING GEAR
DISTRIBUCIÓN**

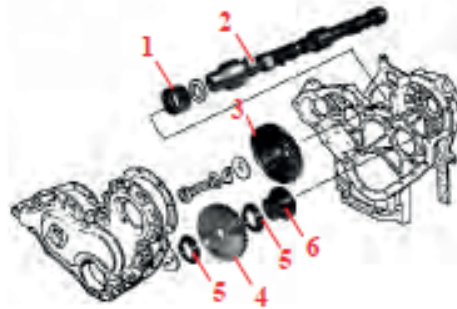

		1	2	3	4	5	6
Tractores Tractors	Engine Motor	Camshaft bush Carg. árbol de Levas	Camshaft Árbol de levas	Camshaft gear Engranaje	Idler gear Engranaje	Idler gear bush Casquillo	Idler hub Espaciador
4 cylinder engines combines / Cosechadoras motores 4 cilindros							
186	A4.212		30/80-4 (31415321, 736818M1)	30/81-3 (31171353, 736254M1)	30/82-4 (41115023, 734738M91)		
8 Plot, 10 Plot	A4.236						
16 Plot, 16, 99, 187, 206, 240, 307, 330	A4.236						
20XP	AT4.236	30/56-1 (31134165, 4222017M1)	⇒ U083371N U083372N ⇒ 30/80-13 (B) (31415384, 3641843M91)	⇒ U083371N 30/81-10 (31171138, 3637421M1) ⇒ U083372N ⇒ 30/81-12 (3117L023, 3641739M1)	30/82-12 (4111A013, 3637075M91)	30/84-8 (0050345, 731033M1)	30/83-1 (33426161, 735852M1)
430, 440, 487, 506	A4.248			30/81-3 (31171353, 736254M1)			
20	A4.248			⇒ U108196N 30/81-3 (31171353, 736254M1) U108197N ⇒ 30/81-14 (3117L012, 3641740M1)	30/82-4 (41115023, 734738M91)		

(A) Fast lift camshaft lobes / Levas del árbol "agudas"
(B) Slow lift camshaft lobes / Levas del árbol "romas"

Part numbers are quoted for reference purposes only.
Our parts and accessories are not original.

Las referencias originales tienen un pequeño identificativo.
Nuestras piezas no son originales.



**TIMING GEAR
DISTRIBUCIÓN**

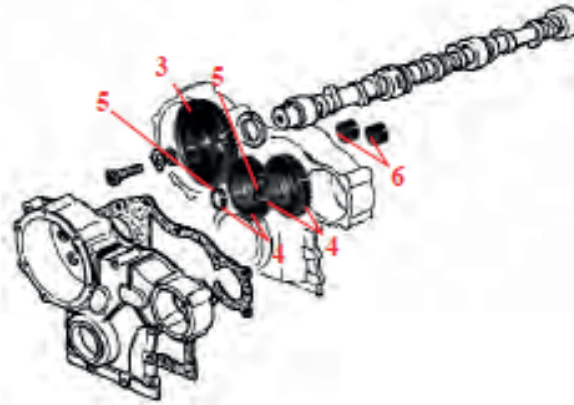

		3	4	5	6
Tractors Tractores	Engine Motor	Camshaft gear Engranaje	Idler gear Engranaje	Idler gear bush Casquillo	Idler hub Espariador
6 cylinder engines combines / Cosechadoras motores 6 cilindros					
500, 507, 510, 515, 520, 525	A6.354	30/81-3 (31171353, 736254M1)		30/84-10 (31134121, 733733M1)	
620, 625, 740, 750	A6.372	30/81-10 (31171138, 3637421M1)			
24	A6.354.4	⇨ U544145E 30/81-3 (31171353, 736254M1) U544146E ⇨ 30/81-10 (31171138, 3637421M1)	LH / Izda. 30/82-11 (41115056, 741263M91) RH / Dvcha. 30/82-10 (41115057, 741266M91)	30/84-9 (2511613, 741265M1)	30/83-2 (32718522, 741262M1)
27, 530, 530S, 535, 800, 805, 810, 815	A6.354.4	30/81-3 (31171353, 736254M1)			
750	A6.372.4				
750, 760	AT6.354.1	30/81-10 (31171138, 3637421M1)		30/84-10 (31134121, 733733M1)	
29	AT6.354.4	30/81-3 (31171353, 736254M1)	LH / Izda. 30/82-11 (41115056, 741263M91)	30/84-9 (2511613, 741265M1)	30/83-2 (32718522, 741262M1)
29XP, 31, 31XP, 560, 565, 660, 665, 750, 760, 820, 825, 830, 835, 840, 845, 850, 855, 860	AT6.354.4	30/81-10 (31171138, 3637421M1)	RH / Dvcha. 30/82-10 (41115057, 741266M91)		

Part numbers are quoted for reference purposes only.
Our parts and accessories are not original.

Las referencias originales tienen un propósito identificativo.
Nuestras piezas no son originales.



**TIMING GEAR
DISTRIBUCIÓN**

A4.212 - A4.236
AT4.236 - A4.248
series 1000 Serie 4 Cyl. / Cil. 2

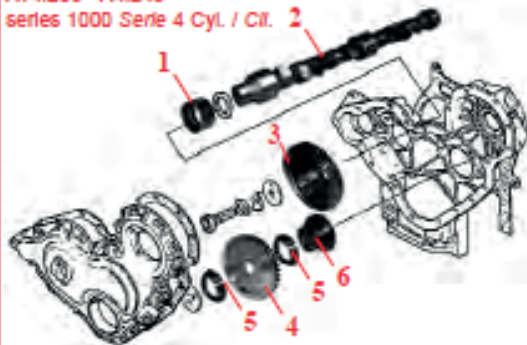

A3.152

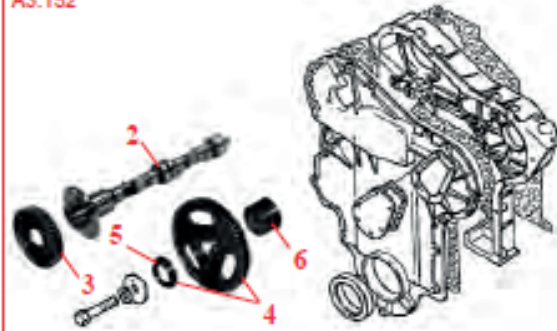

Tractores Tractores	Engine Motor	1 Camshaft bush Carg. árbol de levas	2 Camshaft Árbol de levas	3 Camshaft gear Engranaje	4 Idler gear Engranaje	5 Idler gear bush Carguillo	6 Idler hub Espaciador
Telescopic handlers / Carretillas elevadoras telescópicas							
24	A4.236	30/56-1 (31134165, 4222017M1)	30/80-7 (31415375, 3641841M91)	30/81-12 (3117L023, 3641739M1)	30/82-12 (4111A013, 3637075M91)		
24T	AT4.236		30/80-13 (31415384, 3641843M91)				
8925, 8926, 8937, 8939	1004.4 (Blue)		30/80-12 (31415363, 3641840M91)	30/81-14 (3117L012, 3641740M1)	30/82-4 (41115023, 734738M91)	30/84-8 (0050345, 731033M1)	30/83-1 (33426161, 735852M1)
8925T, 8926T, 8937T, 8939T	1004.4T (Blue)						
8925, 8926, 8937, 8939	1004.42 (Green)				30/81-12 (3117L023, 3641739M1)	30/82-12 (4111A013, 3637075M91)	
8925T, 8926T, 8937T, 8939T	1004.40T (Green)						
3 cylinder engine industrial tractors / Palas retrocargadoras motores 3 cilindros							
203, 205	A3.152						
20, 40	AG3.152						
20, 20B, 20C, 20D, 20E, 20F, 30B, 30H, 40, 203, 205, 2135, 2203, 2205 30E (CE31116, CE31182, CE31183)	AD3.152		30/80-1 (31415261, 733507M1)	30/81-1 (3116K111, 4224245M1)	30/82-1 (31164362, 731205M2)		30/83-3 (0995447, 731204M1)
30E (CE31144, CE31184)	AD3.152						
40E	AT3.152.4		30/80-6 (31415264, 3637539M1)		30/82-13 (4111A015, 3638219M91)	30/84-7 (2511A735, 3637942M1)	

Part numbers are quoted for reference purposes only.
Our parts and accessories are not original.

Las referencias originales tienen un propósito identificativo.
Nuestras piezas no son originales.



**TIMING GEAR
DISTRIBUCIÓN**

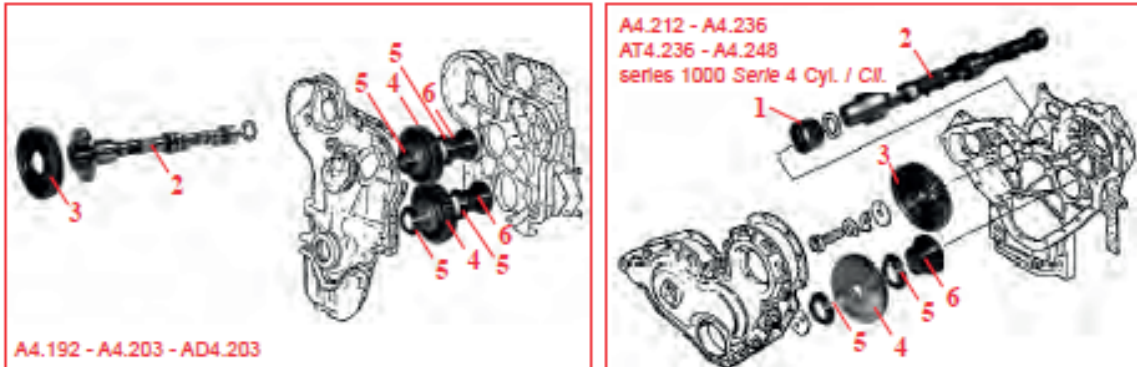

Tractors <i>Tractores</i>	Engine <i>Motor</i>	1 Camshaft bush <i>Carg. árbol de levas</i>	2 Camshaft <i>Árbol de levas</i>	3 Camshaft gear <i>Engranaje</i>	4 Idler gear <i>Engranaje</i>	5 Idler gear bush <i>Casquillo</i>	6 Idler hub <i>Espaciador</i>
4 cylinder engine industrial tractors / Palas retrocargadoras motores 4 cilindros							
356	A4.203				Sup. / Sup. 30/82-2 (0410227, 731034M1)	Sup. / Sup.	
30, 40B, 50, 302, 304, 356, 3165, 3303, 3305 (⇒ UA84217D)	AD4.203			30/81-2 (0410231, 731028M1)	Inf. / Inf. 30/82-3 (0994946, 731628M91)	Inf. / Inf. 30/84-8 (0050345, 731033M1)	
30, 40B, 50, 302, 304, 356, 3165, 3303, 3305 (UA84218D ⇒)	AD4.203				Sup. / Sup. 30/82-15 (41115005, 740865M91)		
50, 50B, 3303, 3305	A4.212			⇒ U106654N 30/81-3 (31171353, 736254M1)	30/82-4 (41115023, 734738M91)		30/83-1 (33426161, 735852M1)
30D, 50, 50B, 50B MKII, 50C, 50D, 60 50E (LD31113, LD31114)	A4.236		⇒ U106654N 30/80-4 (A) (31415321, 736818M1)	U106655N ⇒ 30/81-14 (3117L012, 3641740M1)			
50E (LD31132) 50H (LD31134, LD31163)	A4.236	30/56-1 (31134165, 4222017M1)	U106655N ⇒ 30/80-7 (B) (31415375, 3641841M91)	⇒ U106654N 30/81-10 (31171138, 3637421M1) U106655N ⇒ 30/81-12 (3117L023, 3641739M1)	30/82-12 (4111A013, 3637075M91)		
50E (LD31178)	A4.236		30/80-7 (31415375, 3641841M91)	30/81-14 (3117L012, 3641740M1)	30/82-4 (41115023, 734738M91)		
50H (LD31179) 50H-S, 50H-T	A4.236			30/81-12 (3117L023, 3641739M1)	30/82-12 (4111A013, 3637075M91)		
60HX, 60HX-T	AT4.236		30/80-13 (31415384, 3641843M91)				

(A) Fast lift camshaft lobes / Levas del árbol "agudas"

(B) Slow lift camshaft lobes / Levas del árbol "romas"

Part numbers are quoted for reference purposes only.
Our parts and accessories are not original.

Las referencias originales tienen un propósito identificativo.
Nuestras piezas no son originales.



**TIMING GEAR
DISTRIBUCIÓN**

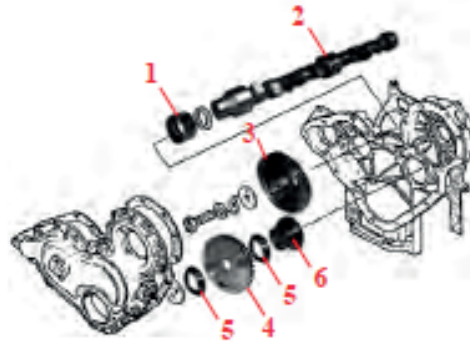

		1	2	3	4	5	6
Tractors Tractores	Engine Motor	Camshaft bush Casp. árbol de levas	Camshaft Árbol de levas	Camshaft gear Engranaje	Idler gear Engranaje	Idler gear bush Caspille	Idler hub Espaciador
4 cylinder engine industrial tractors / Palas retrocargadoras motores 4 cilindros							
50EX	A4.248		30/80-7 (31415375, 3641841M91)	30/81-14 (3117L012, 3641740M1)			
50HX, 60H (LF31128)	A4.248		⇒ U108196N 30/80-4 (A) (31415321, 736818M1)	⇒ U108196N 30/81-3 (31171353, 736254M1)	30/82-4 (41115023, 734738M91)		
50HX, 60H (LF31130, LF31135, LF31164)	A4.248	30/56-1 (31134165, 4222017M1)	U108197N ⇒ 30/80-7 (B) (31415375, 3641841M91)	⇒ U108196N 30/81-14 (3117L012, 3641740M1)		30/84-8 (0050345, 731033M1)	30/83-1 (33426161, 735852M1)
50HX, 60H (LF31180) 50HX-S, 50HX-T, 60H-S	A4.248		30/80-7 (31415375, 3641841M91)	⇒ U108196N 30/81-10 (31171138, 3637421M1)	30/82-12 (4111A013, 3637075M91)		
Ferret & Terex - 4 cylinder engine industrial tractors / Palas retrocargadoras motores 4 cilindros							
750	1004.4 (Blue)		30/80-12 (31415363, 3641840M91)	30/81-14 (3117L012, 3641740M1)			
760, 860, 860S, 860SE, 865, 960, 965	1004.4T (Blue)	30/56-1 (31134165, 4222017M1)			30/82-12 (4111A013, 3637075M91)	30/84-8 (0050345, 731033M1)	30/83-1 (33426161, 735852M1)
750, 750B	1004.42 (Green)			30/81-12 (3117L023, 3641739M1)			
760, 760B, 860, 860B, 860S, 860SE, 960, 960B, 965	1004.40T (Green)						

(A) Fast lift camshaft lobes / Levas del árbol "agudas"

Part numbers are quoted for reference purposes only.
Our parts and accessories are not original.

Las referencias originales tienen un propósito identificativo.
Nuestras piezas no son originales.



AUXILIARY DRIVE
MANDO AUXILIAR DE DISTRIBUCIÓN



Tractors Tractores	Engine Motor	1 Drive shaft Eje mando	2 Gear-shaft assy. Engranaje	3 Front bush Carguillo delantero	4 Rear Bush Carguillo trasero	5 Oil seal Retén bomba	6 Thrust bearing Cojinete axial	7 Bush Carguillo
6 cylinder engines / Motores 6 cilindros								
1100 1200	A6.354 A6.354.1							
1014, 1104	A6.354.1					30/124-1 (B) (2415503, 3639297M1)		
399, 699, 1014, 1024, 1114, 1250, 2620, 2625, 2640, 2645, 2675, 3080, 3090, 3610	A6.354.4	30/120-2 (A) (31173423, 744243M1)	30/121-1 (41115367, 743924M91)	30/122-1 (31134129, 733887M1)	30/123-1 (2511447, 733770M1)	30/124-2 (2418F432, 3640765M1)	30/6121-1 (41425608, 744620M91)	30/6093-1 (2511636, 736612M1)
1105 1130 1135	AT6.354.1 AT6.354 AT6.354.1							
1134, 2680, 2685, 2705, 2720, 2725, 3630, 3650	AT6.354.4	30/120-2 (A) (31173423, 744243M1)				30/124-2 (2418F432, 3640765M1)		
6 cylinder engines combines / Cosechadoras motores 6 cilindros								
500, 507, 510, 515, 520, 525	A6.354					30/124-1 (B) (2415503, 3639297M1)		
620, 625	A6.372					30/124-2 (2418F432, 3640765M1)		
750, 760	AT6.354.1		30/121-1 (41115367, 743924M91)	30/122-1 (31134129, 733887M1)	30/123-1 (2511447, 733770M1)		30/6121-1 (41425608, 744620M91)	30/6093-1 (2511636, 736612M1)
740, 750	A6.372							
24, 27, 530, 530S, 535, 800, 805, 810, 815	A6.354.4							
29, 29XP, 31, 31XP, 560, 565, 660, 665, 750, 760, 820, 825, 830, 835, 840, 845, 850, 855, 860	AT6.354.4	30/120-2 (A) (31173423, 744243M1)				30/124-2 (2418F432, 3640765M1)		
750	A6.372.4							

(A) 30/120-2 shaft take 3/8" UNF screws / El eje 30/120-2 utiliza un juego de tornillos 3/8" UNF

(B) 30/124-1 is the nitrile seal used with the early drive shaft 31173409. 30/124-2 is used with the later drive shaft 31173422, 743276M1.

El retén de nitrilo 30/124-1 se usa sobre los primeros ejes auxiliares 31173409. 30/124-2 se usa sobre los últimos ejes auxiliares 31173422, 743276M1

Part numbers are quoted for reference purposes only.



Las referencias originales tienen un propósito identificativo.

Our parts and accessories are not original.

Nuestras piezas no son originales.



OIL FILLER CAP
TAPON ACEITE

Tractors Tractores	Engine Motor	Ref. Ref.	Illustration Ilustración
33, 133, 135	A3.144	30/85-2 (2487854, 2487841, 734962M91, 1851752M91)	
33	A3.152		
25, 122	A4.99		
23, 30, 130, 825	A4.107		
65	A4.192		
65, 865	A4.203		
65, 155, 158, 158, MKIII, 165, 260, 560765	AD4.203		
400, 410, 415	A4.300		
133, 134, 135, 140, 145, 148, 150, 152, 154, 230, 233, 234, 235, 240, 244CF, 245, 250, 253 (Italy), 254, 255, 333, 334V, 340, 342, 350, 353, 354, 356CF, 550, 2205, 3210	AD3.152		
253 (UK), 264TCF, 352, 355, 360, 363, 364, 366CF	AT3.152.4		
2210	903.27		
165, 174	A4.212		
168, 168MKIII, 174, 174C, 175, 184, 265, 274, 274S, 274SK, 275, 275E, 284, 375E, 377, 387, 565, 575, 675, 3050 174F/S, 184F/S, 273, 283 (Timing gear housing / Carcasa de la distribución) 365, 375 (⇔ U382174U)	A4.236		
178, 185, 188, 194, 194C, 285, 290, 290E, 294S, 390E, 397, 590, 690, 3055, 3060 194F/S, 293, 294 (Timing gear housing / Carcasa de la distribución) 390 (⇔ U382174U)	A4.248		
487, 506 (Timing gear housing / Carcasa de la distribución)			
390T, 393TLX, 396CT, 397T, 398, 698T, 1004T, 1007, 3065, 3065S, 3070 3075, 6130, 6140, 6150	AT4.236 1004.4T (Blue)		
2230	1004.42		
1200	A6.354.1		
850, 855, 860	AT6.354.4CC		
186	A4.212		
174F/S, 184F/S, 273, 283 (Rockar cover / Balancines) 274C, 274CF, 284, 367CF, 373, 374, 376C, 383, 384, 3220, 3225 187 (Rockar cover / Balancines), 8Plot, 10Plot, 16, 16Plot, 206, 240, 307, 330	A4.236	30/85-3 (2487845, 1851753M1)	
194F/S, 293, 294 (Rockar cover / Balancines) 294C, 393, 394, 396C, 3235	A4.248		
487, 506 (Rockar cover / Balancines), 20, 430, 440			
788	A4.270		
4225, 4235, 4240 (Early / Primeros modelos)	A4.41 (Blue)		
4245, 4255 (Early / Primeros modelos)	1004.4T (Blue)		
500, 507, 510, 515, 520, 525	A6.354		
699, 1250			
24, 530, 530S, 535, 800, 805, 810, 815	A6.354.4		
27, 29, 29XP, 31, 31XP, 560, 565, 660, 665, 750, 760, 820, 825, 830, 835, 840, 845, 850, 855, 860	AT6.354.4		
620, 625, 740, 750	A6.372		
750	A6.372.4		
135	AG3.152		
135 (USA)	AD3.152		
99, 187 (Timing gear housing / Carcasa de la distribución)	A4.236		
285 (USA), 592, 595, 1080, 1085	A4.318		
285 (USA), 298, 592, 595, 698, 1004	A4.318.2		
263 (UK)	903.27T	30/85-13 (2487983, 3639319M1)	
362, 362N, 372N 365, 375 (U382175U ⇔)	A4.236		
382N 390 (U382175U ⇔)	A4.248		

Part numbers are quoted for reference purposes only.
Our parts and accessories are not original.

Las referencias originales tienen un propósito identificativo.
Nuestras piezas no son originales.



DIPSTICK
VARILLAS NIVEL DE ACEITE

Tractors Tractores	Engine Motor	Ref. Ref.	Illustration Ilustración
35, 133, 135	A3.144	30/86-1 (31786412, 731117M91)	
35	A3.152		
135	AG3.152		
133, 134, 135, 140, 145, 148, 150, 152, 154, 230, 233, 234, 235, 240, 244CF, 245, 250, 253 (Italy), 254, 255, 333, 334V, 340, 342, 350, 353, 354, 356CF, 550, 2205	AD3.152		
164T, 253 (UK), 263T (Italy), 264T, 352, 355, 360, 363, 364, 366CF	AT3.152.4		
65	A4.192		
65, 865	A4.203		
65, 155, 158, 158MKIII, 165, 260, 560, 765	AD4.203		
165, 174	A4.212		
168, 174, 175, 184, 273,274S, 274SK, 283, 284S, 565, 575 168MKIII, 265, 274, 275, 675 (U917431K)	A4.236		
178, 185, 188, 194, 285, 293, 294S	A4.248		
362, 362N, 365, 375, 3050 372N (Early / Primeros modelos)	A4.236	30/86-5 (31787455, 747476M91)	
382N, 390 (Early / Primeros modelos) 3055, 3060	A4.248		
390T, 398 (Early / Primeros modelos) 698T (1984), 1004T, 3065, 3065S, 3070	AT4.236		

SUMP PLUG
TAPÓN DE CARTER

All models / Todos los modelos

30/88-1
(2487004,
32186405,
376501X1,
748160M1)



BLOCK TAPS
GRIFO DEL BLOQUE

Engine Motor	Ref. Ref.	Illustration Ilustración
Standard engines Motor estándar	30/55-5 (828085M1, 825326M1) 1/2" UNF	
Perkins engines Motor Perkins	30/55-2 (31419, 1851095M2) 1/4" BSP	

Part numbers are quoted for reference purposes only.
Our parts and accessories are not original.

Las referencias originales tienen un propósito identificativo.
Nuestras piezas no son originales.



OIL PUMPS
BOMBAS DE ACEITE

Tractors Tractores	Engine Motor	Oil pump Bomba de aceite	Idler gear Engranaje	Idler bush Casquillo	Illustration Ilustración
3 cylinder engines / Motores 3 cilindros					
35, 133, 135	A3.144				
35	A3.152				
135	AG3.152				
133, 134, 135, 140, 145, 148, 150, 152, 154, 230, 233, 234, 235, 240, 244CF, 245, 250, 253 (Italy), 254, 255, 333, 334V, 340, 342, 350, 353, 354, 356CF, 550, 2205, 3210	AD3.152	30/90-1 (41314187, 3637359M91)	30/91-1 (41115086, 3637351M91)	30/84-5 (0050265, 731236M1)	
164T, 253 (UK), 263T (Italy), 264T, 352, 355, 360, 363, 364, 366CF	AT3.152.4				
2210, 3315, 4215, 4315	903.27				
263 (UK), 2220, 3325, 4220, 4320	903.27T				
4 cylinder engines / Motores 4 cilindros					
25, 122	A4.99	30/90-11 (41314089, 3640285M1)			
25, 30, 130, 825	A4.107				
65	A4.192				
65, 865	A4.203	30/90-2 (41314189, 3637471M91)	30/91-2 (0994967, 731635M91)		
65, 155, 158, 158MKIII, 165, 260, 560, 765	AD4.203				
165 (UK) 174 (⇒ 212UA170105)	A4.212	30/90-3 (41314182, 3637470M91)	30/91-3 (41115085, 3637422M91)	30/84-11 (2511437, 1447752M1)	
168MKIII, 174, 184, 265, 273, 274, 275, 283, 284, 565, 575, 675 (U880191K ⇒)	A4.236				
275E, 362, 362N, 365, 367CF, 372N, 373, 374, 375, 375E, 376C, 377, 383, 384, 387, 3050, 3220, 3225					
178, 185, 188, 194, 285, 290, 293, 294, 590, 690 (U880191K ⇒)	A4.248	30/90-13 (A) (4132F041, 3637489M91)			
290E, 382N, 390, 390E, 393, 394, 396C, 397, 3055, 3060, 3235					
390T, 393TLX, 394TAQ, 396CT, 397T, 398, 698T, 1004T, 1007, 3065, 3065S, 3070	AT4.236				
285 (USA), 592, 595, 1080, 1085	A4.318				
285 (USA), 298, 592, 595, 698, 1004	A4.318.2	30/90-12 (41314113, 737964M92)			

(A) 30/90-13 is included in the mid-mounted balancer units see page MF-114-115







La bomba 30/90-13 se incluye en el equilibrador de montaje central, ver páginas MF 114 - 115

Part numbers are quoted for reference purposes only.
Our parts and accessories are not original.

Las referencias originales tienen un propósito identificativo.
Nuestras piezas no son originales.



OIL PUMPS
BOMBAS DE ACEITE

Tractors Tractores	Engine Motor	Oil pump Bomba de aceite	Idler gear Engranaje	Idler bush Casquillo	Illustration Ilustración
4 cylinder engines / Motores 4 cilindros					
275E, 290E, 375E, 390E, 4225, 4235, 4240, 6110, 6120	A4.41 (Blue)	30/90-13 (A) (4132F041, 3637489M91)			
3075, 4245, 4255, 6130, 6140, 6150	1004.4T (Blue)				
374, 3220, 3330, 4225, 4325	1004.40 (Green)				
3350, 3355, 4235, 4245, 4255, 4345, 4355, 6235, 6245, 6255	1004.40T (Green)				
4265, 4365, 6265	1004.40TW				
394, 2230, 3235, 3340, 4235 (USA), 4335	1004.42				
6 cylinder engines / Motores 6 cilindros					
1100 1014, 1104, 1200	A6.354 A6.354.1	30/90-5 (41314067, 736012M91)			
1105 1130 1135	AT6.354.1 AT6.354 AT6.354.1				
399, 699, 1014, 1024, 1114, 1250, 2620, 2625, 2640, 2645, 2675, 3080, 3090, 3610	A6.354.4	30/90-14 (4132F015, 747292M91)			
1134, 2680, 2685, 2705, 2720, 2725, 3630, 3650	AT6.354.4	30/90-23 (4132F016, 747293M91)			
396, 399, 3085, 3095, 3115, 4260, 4270, 6160, 6170	1006.6 (Blue)	30/90-51 (4132F043, 3638595M91)			
3120, 3120T, 3125, 3140, 3635, 3645, 3655, 3660, 6180, 6190, 8110, 8120, 8130	1006.6T (Blue)	30/90-54 (4132F057, 3641171M91)			
4260, 4360, 6260	1006.60 (Green)				
4270, 4370, 6170, 6180, 6270, 6280, 6290, 8120, 8210, 8220	1006.60T (Green)				
3680, 3690	612DS	30/90-57 (3637653M91, V836338187)			
3690, 8160	634DS				
8250, 8260 (⇔ J7890)	634DSBAE				
3670, 8140, 8150	620DS	30/90-59 (3638940M91, V836322243, V836852607)			
8240 (⇔ J7890)	620DSRAE	30/90-58 (V836855300)			
8240 (J7891 ⇔)	620DSRAE				
8240 Xtra	620DWB.AE				
8250, 8260 (J8791 ⇔)	634DSBAE				
8250 Xtra, 8260 Xtra	634DWB.AE				
8260	634DSBIE				
8170, 8180, 8270, 8280	645DSBIE				
8270 Xtra, 8280 Xtra	645DSBAE				

(A) 30/90-13 is included in the mid-mounted balancer units see page MF-114-115

La bomba 30/90-13 se incluye en el equilibrador de montaje central, ver páginas MF 114 - 115

Part numbers are quoted for reference purposes only.

Our parts and accessories are not original.

Las referencias originales tienen un propósito identificativo.

Nuestras piezas no son originales.



OIL PUMPS
BOMBAS DE ACEITE





Tractor <i>Tractores</i>	Engine <i>Motor</i>	Oil pump <i>Bomba de aceite</i>	Idler gear <i>Engranaje</i>	Idler bush <i>Casquillo</i>	Illustration <i>Ilustración</i>
 4 cylinder engines combines / Cosechadoras motores 4 cilindros					
186	A4.212	30/90-3 (41314182, 3637470M91)	30/91-3 (41115085, 3637422M91)	30/84-11 (2511437, 1447752M1)	
8 Plot, 10 Plot, 16 Plot, 16, 99, 187, 206, 240, 307, 330	A4.236				
20, 430, 440, 487, 506	A4.248				
20XP	AT4.236	30/90-55 (4132F012, 3640287M1)			
400 (6929119 ^{co})	A4.300	30/90-12 (41314113, 737964M92)			
 6 cylinder engines combines / Cosechadoras motores 6 cilindros					
500, 507, 510, 515, 520, 525	A6.354	30/90-4 (41314131, 739400M91)			
620, 625, 740, 750	A6.372	30/90-5 (41314067, 736012M91)			
750, 760	AT6.354.1				
24, 27, 530, 530S, 535, 800, 805, 810, 815	A6.354.4	30/90-14 (4132F015, 747292M91)			
750	A6.372.4				
29, 29XP, 31, 31XP, 560, 565, 660, 665, 750, 760, 820, 825, 830, 835, 840, 845, 850, 855, 860	AT6.354.4	30/90-23 (4132F016, 747293M91)			
 Telescopic handlers / Carretillas elevadoras telescópicas					
8925, 8926, 8937, 8939	1004.4 (Blue)	30/90-52 (4132F051, 3640908M91)		30/84-11 (2511437, 1447752M1)	
8925, 8926, 8937, 8939	1004.42 (Green)				
8925T, 8926T, 8937T, 8939T	1004.4T (Blue)	30/90-53 (4132F056, 4222282M91)			
8925T, 8926T, 8937T, 8939T	1004.40T (Green)				

Part numbers are quoted for reference purposes only.
Our parts and accessories are not original.

Las referencias originales tienen un propósito identificativo.
Nuestras piezas no son originales.



OIL PUMPS
BOMBAS DE ACEITE

Tractors Tractores	Engine Motor	Oil pump Bomba de aceite	Idler gear Engranaje	Idler bush Casquillo	Illustration Ilustración
3 cylinder engine industrial tractors / Palas retrocargadoras motores 3 cilindros					
203, 205	A3.152	30/90-1 (41314187, 3637359M91)	30/91-1 (41115086, 3637351M91)	30/84-5 (0050265, 731236M1)	
20, 40	AG3.152				
20, 20B, 20C, 20D, 20E, 20F, 30B, 30E, 30H, 40, 203, 205, 2135, 2203, 2205	AD3.152				
40E	AT3.152.4				
4 cylinder engine industrial tractors / Palas retrocargadoras motores 4 cilindros					
356	A4.203	30/90-2 (41314189, 3637471M91)	30/91-2 (0994967, 731635M91)		
30, 40B, 50, 302, 304, 356, 3165, 3303, 3305	AD4.203				
50, 50B, 3303, 3305	A4.212	30/90-3 (41314182, 3637470M91)	30/91-3 (41115085, 3637422M91)	30/84-11 (2511437, 1447752M1)	
30D, 50D, 50E, 60 (U880191K ⇔)	A4.236	30/90-13 (A) (4132F041, 3637489M91)			
50EX (LF31164) 50HX, 60H (LF31130, LF31164)	A4.248				
Ferret & Terex - 4 cylinder engine industrial tractors / Palas retrocargadoras motores 4 cilindros					
750	1004.4 (Blue)	30/90-52 (4132F051, 3640908M91)		30/84-11 (2511437, 1447752M1)	
750, 750B	1004.42 (Green)				
760, 860, 860S, 860SE, 865, 960, 965	1004.4T (Blue)	30/90-53 (4132F056, 4222282M91)			
760, 760B, 860, 860B, 860S, 860SE, 960, 960B, 965	1004.40T (Green)				

(A) 30/90-13 is included in the mid-mounted balancer units see page MF-114-115

(A) La bomba 30/90-13 se incluye en el equilibrador de montaje central, ver páginas MF-114-115

OIL PUMP ROTOR ASSEMBLY
ROTOR DE BOMBA DE ACEITE

TEA20, TED20, FE35, 135

30/92-11
(827501M91)



TEF20, FE35

30/92-10
(826059M91)



Part numbers are quoted for reference purposes only.
Our parts and accessories are not original.

Las referencias originales tienen un propósito identificativo.
Nuestras piezas no son originales.



**FRONT MOUNTED BALANCER UNIT (4 BOLT FIXING)
EQUILBRADOR DE MONTAJE FRONTAL (FIJACIÓN 4 TORNILLOS)**

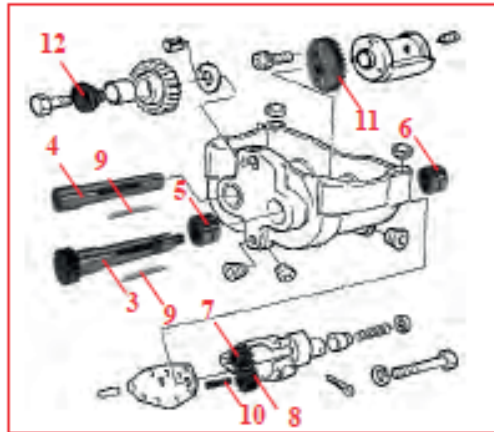

Tractors <i>Tractores</i>	Engine <i>Motor</i>	1 Balancer unit <i>Equilibrador</i>	2 Rep. kit <i>Juego rep.</i>	3 Drive shaft <i>Eje conductor</i>	4 Driven shaft <i>Eje conducido</i>	5 Front bearing <i>Rodam. del.</i>	6 Rear bearing <i>Rodam. traz.</i>	
4 cylinder engines / Motores 4 cilindros								
165 (France) 174 (212UA170106 ⇨)	A4.212	30/90-6 (41733082, 746432M91)	Minor <i>pequeño</i> 30/92-4 (A) (B1244)	30/93-1 (31171276, 743137M1)	30/93-2 (32731127, 743115M1)	30/89-1 (C) (2558375, 742207M1)	30/89-2 (C) (2558371, 742208M1)	
168, 168MKIII, 174, 175, 184, 255 (USA), 265, 273, 274, 275, 283, 284, 565, 575, 675 (⇨ USS0190K)	A4.236		Major <i>Grande</i> 30/92-3 (B) (B1243)				30/89-3 (D) (2557182, 746697M1)	30/89-4 (D) (2557181, 746696M1)
178, 185, 188, 194, 285, 290, 293, 294, 590, 690 (⇨ USS0190K)	A4.248							

Tractors <i>Tractores</i>	Engine <i>Motor</i>	7 Drive gear <i>Engranaje eje</i>	8 Driven gear <i>Engr. conducido</i>	9 Woodruff key <i>Chaveta</i>	10 Dowel pin <i>Parador</i>	11 Balancer gear <i>Engranaje</i>	12 Hub <i>Soporte</i>	
4 cylinder engines / Motores 4 cilindros								
165 (France) 174 (212UA170106 ⇨)	A4.212	30/94-2 (31165531, 743020M1)	30/94-3 (31165461, 734850M1)	30/94-4 (2576675, 376588X1)	30/94-5 (32455123, 734849M1)	30/94-6 (31164582, 746694M1)	30/99-1 (33451801, 734905M2)	
168, 168MKIII, 174, 175, 184, 255 (USA), 265, 273, 274, 275, 283, 284, 565, 575, 675 (⇨ USS0190K)	A4.236							
178, 185, 188, 194, 285, 290, 293, 294, 590, 690 (⇨ USS0190K)	A4.248							

(A) Contents of 3092-4 are 1 of each of / *El juego 3092-4 incluye cada una de las siguientes piezas: 3093-1, 3094-2, 3094-3, 3094-4 & 3094-5.*

(B) Contents of 3092-3 are 1 of each of / *El juego 3092-3 incluye las siguientes piezas y cantidades: 3093-1, 3093-2, 3094-2, 3094-3, 3094-5 & 2x 3089-3, 2x3089-4 2x3094-4.*

(C) 30/89-1 & 30/89-2 are plain needle bearings for the early balancer unit 41733402.

30/89-1 & 30/89-2 son rodamientos de agujas planas sobre los primeros equilibradores 41733402.

(D) 30/89-3 & 30/89-4 are grooved needle bearings for the later balancer units 41733066 and 41733082.

30/89-3 & 30/89-4 son rodamientos de agujas acanaladas sobre los últimos equilibradores 41733066 and 41733082.

Part numbers are quoted for reference purposes only.
Our parts and accessories are not original.

Las referencias originales tienen un propósito identificativo.
Nuestras piezas no son originales.



FRONT MOUNTED BALANCER UNIT (4 BOLT FIXING)
EQUILIBRADOR DE MONTAJE FRONTAL (FIJACIÓN 4 TORNILLOS)

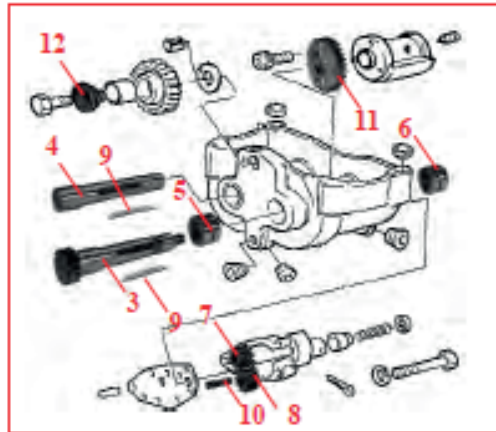

Tractors <i>Tractores</i>	Engine <i>Motor</i>	1 Balancer unit <i>Equilibrador</i>	2 Rep. kit <i>Juego rep.</i>	3 Drive shaft <i>Eje conductor</i>	4 Driven shaft <i>Eje conducido</i>	5 Front bearing <i>Rodam. del.</i>	6 Rear bearing <i>Rodam. tras.</i>
Telescopic handlers / Carretillas elevadoras telescópicas							
24	A4.236						
24T	AT4.236						
4 cylinder engine industrial tractors <i>Palas retrocargadoras motores 4 cilindros</i>							
30D, 50D, 50E, 60 (⇨ U880190K)		30/90-6 (41733082, 746432M91)	Minor <i>Pequeño</i> 30/92-4 (A) (B1244)	30/93-1 (31171276, 743137M1)	30/93-2 (32731127, 743115M1)	30/89-1 (C) (2558375, 742207M1)	30/89-2 (C) (2558371, 742208M1)
50, 50B, 50B MKII, 50C, 50H, 50H-S, 50H-T	A4.236					Major <i>Grande</i> 30/92-3 (B) (B1243)	30/89-3 (D) (2557182, 746697M1)
50EX (LF31181) 50HX, 60H (LF31128, LF31135, LF31180)	A4.248						
50HX-S, 50HX-T, 60H-S 60HX, 60HX-T	AT4.236						

Tractors <i>Tractores</i>	Engine <i>Motor</i>	7 Drive gear <i>Engranaje eje</i>	8 Driven gear <i>Eng. conducido</i>	9 Woodruff key <i>Chaveta</i>	10 Dowel pin <i>Pasador</i>	11 Balancer gear <i>Engranaje</i>	12 Hub <i>Soporte</i>
Telescopic handlers / Carretillas elevadoras telescópicas							
24	A4.236						
24T	AT4.236						
4 cylinder engine industrial tractors <i>Palas retrocargadoras motores 4 cilindros</i>							
30D, 50D, 50E, 60 (⇨ U880190K)		30/94-2 (31165531, 743020M1)	30/94-3 (31165461, 734850M1)	30/94-4 (2576675, 376588X1)	30/94-5 (32455123, 734849M1)	30/94-6 (31164582, 746694M1)	30/99-1 (33451801, 734905M2)
50, 50B, 50B MKII, 50C, 50H, 50H-S, 50H-T	A4.236						
50EX (LF31181) 50HX, 60H (LF31128, LF31135, LF31180)	A4.248						
50HX-S, 50HX-T, 60H-S 60HX, 60HX-T	AT4.236						

- (A) Contents of 30/92-4 are 1 of each of / *El juego 30/92-4 incluye cada uno de las siguientes piezas: 30/93-1, 30/94-2, 30/94-3, 30/94-4 & 30/94-5.*
- (B) Contents of 30/92-3 are 1 of each of / *El juego 30/92-3 incluye las siguientes piezas y cantidades: 30/93-1, 30/93-2, 30/94-2, 30/94-3, 30/94-5 & 2x 30/89-3, 2x30/89-4 2x30/94-4.*
- (C) 30/89-1 & 30/89-2 are plain needle bearings for the early balancer unit 41733402.
30/89-1 & 30/89-2 son rodamientos de agujas planos sobre los primeros equilibradores 41733402.
- (D) 30/89-3 & 30/89-4 are grooved needle bearings for the later balancer units 41733066 and 41733082.
30/89-3 & 30/89-4 son rodamientos de agujas acanalados sobre los últimos equilibradores 41733066 and 41733082.

Part numbers are quoted for reference purposes only.
Our parts and accessories are not original.

*Las referencias originales tienen un propósito identificativo.
Nuestras piezas no son originales.*



MID-MOUNTED BALANCER UNIT (6 BOLT FIXING)
EQUILBRADOR MONTAJE MEDIO (FIJACIÓN 6 TORNILLOS)

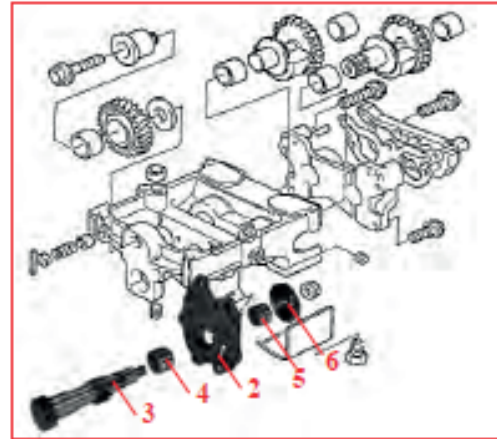
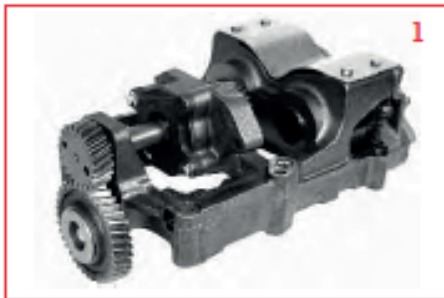

		1	2	3	4	5	6
Tractors <i>Tractores</i>	Engine <i>Motor</i>	Balancer unit <i>Equilibrador</i>	Oil pump <i>Bomba aceite</i>	Drive shaft <i>Eje conductor</i>	Front bearing <i>Rodam. del.</i>	Rear bearing <i>Rodam. tras.</i>	Balancer gear <i>Engranaje</i>
4 cylinder engines / Motores 4 cilindros							
168MKIII, 174, 184, 265, 273, 274, 275, 283, 284, 565, 575, 675 (U880191K ⇔)	A4.236	30/90-15 (4111K064, 4224110M91)					
275E, 367CF, 373, 374, 375E, 376C, 377, 383, 384, 387, 3050, 3220, 3225 362, 362N, 365, 372N, 375 (⇔ U171963P)							
178, 185, 188, 194, 265, 290, 293, 294, 390, 690 (U880191K ⇔)	A4.248						
290E, 390E, 393, 394, 396C, 397, 3055, 3060, 3235							
362, 362N, 365, 372N, 375, (U171964P ⇔)	A4.236	30/90-17 (4111K059, 4224107M91)	30/90-13 (4132F041, 3637489M91)	30/93-10 (3117V003, 3637593M1)	30/89-5 (2551A009, 1447727M91)	30/89-6 (2551A014, 1447723M1)	30/94-11 (3116W001, 746954M1)
382N, 390	A4.248						
393TLX, 394TAQ, 396CT, 397T, 698T, 1004T, 1007, 3065, 3065S, 3070 390T, 398 (⇔ U171963P)	AT4.236	30/90-16 (4111K066, 4224141M91)					
390T, 398 (U171964P ⇔)	AT4.236	30/90-18 (4111K062, 4224108M91)					
275E, 290E, 375E, 390E	A4.41	30/90-17 (4111K059, 4224107M91)					
4225, 4235, 4240, 6110, 6120	A4.41 (Blue)	30/90-15 (4111K064, 4224110M91)					

Part numbers are quoted for reference purposes only.
Our parts and accessories are not original.

Part numbers are quoted for reference purposes only.
v parts and accessories are not original.



MID-MOUNTED BALANCER UNIT (6 BOLT FIXING)
EQUILIBRADOR MONTAJE CENTRAL (FIJACIÓN 6 TORNILLOS)

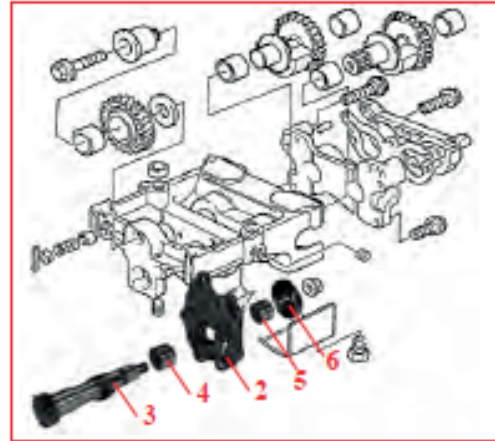

		1	2	3	4	5	6
Tractors <i>Tractores</i>	Engine <i>Motor</i>	Balancer unit <i>Equilibrador</i>	Oil pump <i>Bomba aceite</i>	Drive shaft <i>Eje conductor</i>	Front bearing <i>Rodam. del.</i>	Rear bearing <i>Rodam. tras.</i>	Balancer gear <i>Engranaje</i>
4 cylinder engines / Motores 4 cilindros							
3075, 6130, 6140, 6150	1004.4T	30/90-16 (4111K066, 4224141M91)					
4245, 4255	1004.4T (Blue)	30/90-18 (4111K062, 4224108M91)					
374, 3220, 3330	1004.40 (Green)	30/90-16 (4111K066, 4224141M91)					
4225, 4325	1004.40 (Green)	30/90-18 (4111K062, 4224108M91)					
3350, 3355	1004.40T	30/90-16 (4111K066, 4224141M91)					
4235, 4245, 4255, 4345, 4355, 6235, 6245, 6255	1004.40T (Green)	30/90-18 (4111K062, 4224108M91)	30/90-13 (4132F041, 3637489M91)	30/93-10 (3117V003, 3637593M1)	30/89-5 (2551A009, 1447727M91)	30/89-6 (2551A014, 1447723M1)	30/94-11 (3116W001, 746954M1)
4265, 4365, 6265	1004.40TW (Green)	30/90-18 (4111K062, 4224108M91)					
394, 2230, 3235, 3340	1004.42 (Green)	30/90-15 (4111K064, 4224110M91)					
4235 (USA), 4335	1004.42 (Green)	30/90-17 (4111K059, 4224107M91)					
4 cylinder engine industrial tractors <i>Pala retrocargadora: motores 4 cilindros</i>							
30D, 50D, 50E, 60 (U880191K ↔)	A4.236	30/90-15 (4111K064, 4224110M91)					
50EX (LF31164) 50HX, 60H (LF31130, LF31164)	A4.248						

Part numbers are quoted for reference purposes only.
Our parts and accessories are not original.

Las referencias originales tienen un propósito identificativo.
Nuestras piezas no son originales.







**HEATING PLUGS
CALENTADORES**



Tractors <i>Tractores</i>	Engine <i>Motor</i>	Fig.	Ref. <i>Ref.</i>	OEM	Thread <i>Rosca</i>	Type <i>Tipo</i>
FE35 65, 765	23C A4.192	1	30/60-1		1/2 BSP	Screw connector <i>Con tornillo</i>
		2	30/60-22		1/2 BSP	Plug connector <i>Con fastón</i>
Atmospheric engines <i>Motores atmosférico</i>		1	30/60-2	2666103, 893501M1	7/8 UNF	Screw connector <i>Con tornillo</i>
A3.152, A4.192, A4.203, A4.212, A4.236, A4.248, A6.354, 1004, 1006, 620, 634, 645		2	30/60-3	2666108, 3583543M2	7/8 UNF	Plug connector <i>Con fastón</i>
Turbo engines <i>Motores turbo</i>		2	30/60-23	1854125M1	7/8 UNF	Plug connector <i>Con fastón</i>
Auxiliary tank / Depósito auxiliar						
FE35, 37, 65, 133, 135, 140, 145, 148, 152, 165, 175, 178, 230, 240, 245, 250, 765, 1200, 1250 <i>Industrial / Industrial 50, 50B, 50E</i>		3	30/61-3	37721551, 891969M91	3/8 UNF	

PIPE FITTINGS & AUX. TANK COUPLINGS

RÁCORES Y ACOPLAMIENTOS PARA TUBERIAS Y DEPÓSITO AUXILIAR

3/8" ± 24 UNF			Pipe / Tubo
	69/9198-11 69/9198-15 69/9198-33	21mm 14.4mm 18mm	69/9197-2 Ø 4.76mm - 3/16" Sold by meter / Por metros
	69/9198-13 69/9198-16	17.5mm 16mm	
	69/9198-23	33.2mm	
	69/9198-24	28mm	
			

Part numbers are quoted for reference purposes only.
Our parts and accessories are not original.

Las referencias originales tienen un propósito identificativo.
Nuestras piezas no son originales.



FUEL PUMPS
BOMBINES DE ALIMENTACIÓN



Tractors Tractores	Engine Motor	Fig.	Ref. Ref.	OEM	Observation Comentario	Repair kit Juego de reparación
3 cylinder engines / Motores 3 cilindros						
35, 133, 135 35 133, 135, 140, 145, 148, 150, 152, 154	A3.144 A3.152 AD3.152	1	30/100-3	4222094M91 ULPK0018	2 holes / agujeros Glass bowl Vaso de cristal	30/101-3 (4222118M91, ULPR0006)
133, 135 35 133, 134, 135, 140, 145, 148, 150, 152, 154, 230, 233, 234, 235, 240, 245, 250, 253 (Italy), 254, 255, 550	A3.144 A3.152 AD3.152	2	30/100-4	4222111M91 ULPK0006	2 holes / agujeros	30/101-4 (4222109M91, ULPR0003)
133, 134, 135, 145, 152, 154, 230, 233, 234, 240, 244CF, 250, 253 (Italy), 254, 255, 333, 334V, 340, 342, 350, 353, 354, 356CF, 2205, 3210	AD3.152					
164T, 253 (UK), 263T (Italy), 264T, 352, 355, 360, 363, 364, 366CF	AT3.152.4	3	30/100-19	4222090M91 ULPK0004	4 holes / agujeros	30/101-10 (4222125M91, ULPR0005)
2210, 3315, 4215, 4315	903.27					
263 (UK), 2220, 3325, 4220, 4320	903.27T					
4 cylinder engines / Motores 4 cilindros						
TEF20	20C Diesel	4	30/100-1	826154M91	2 holes / agujeros	30/101-4 (4222109M91, ULPR0003)
FE35 (⇔ SJ37180E)	23C Diesel					
FE35 (SJ37181E ⇔), 835	23C Diesel	5	30/100-2	1884857M91	2 holes / agujeros	
25, 30, 130, 825	A4.107	6	30/100-17	4222174M91 ULPK0017	2 holes / agujeros	30/101-4 (4222109M91, ULPR0003)
65	A4.192					
65, 865	A4.203	7	30/100-5	4222452M91 ULPK0009	Glass bowl Vaso de cristal	30/101-5 (4222110M91, ULPR0004)
65, 155, 158, 165, 765	AD4.203					
65, 155, 158, 165, 765	AD4.203	8	30/100-6	4222107M91 ULPK0010	2 holes / agujeros	
158MKIII, 260, 560	AD4.203	9	30/100-71	4222121M91 ULPK0008	4 holes / agujeros	30/101-10 (4222125M91, ULPR0005)
165, 174	A4.212					
168, 175	A4.236	10	30/100-7	4222104M91 ULPK0011	2 holes / agujeros	30/101-7 (1883344M92, 26410050)
168, 174, 175, 184, 265, 273, 274, 275, 275E, 283, 284, 362, 362N, 365, 367CF, 372N, 373, 374, 375, 375E, 376C, 383, 384, 565, 575, 675, 3050, 3220, 3225	A4.236	11	30/100-10 A=200°	4222108M91 ULPK0001	4 holes / agujeros	30/101-10 (4222125M91, ULPR0005)
165, 168, 174, 175, 178, 184, 265, 273, 274, 275, 284, 373, 374, 377, 383, 384, 387, 393, 565, 575	A4.236		30/100-8 A=140°	4222091M91 ULPK0003	4 holes / agujeros	

'A' is the angle between the inlet and outlet pipe. / 'A' es el ángulo entre las tuberías de entrada y salida.

Part numbers are quoted for reference purposes only.
Our parts and accessories are not original.

Part numbers are quoted for reference purposes only.
Our parts and accessories are not original.



FUEL PUMPS
BOMBINES DE ALIMENTACIÓN

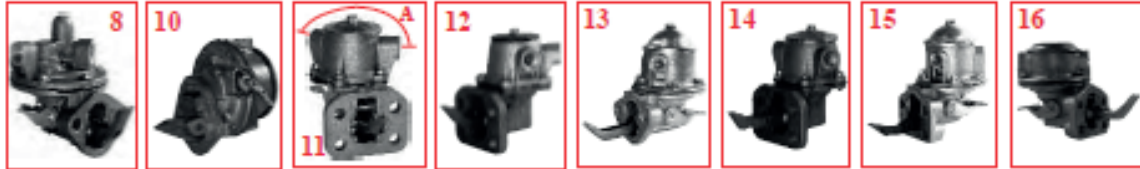

Tractors Tractores	Engine Motor	Fig.	Ref. Ref.	OEM	Observation Comentario	Repair kit Juego de reparación					
4 cylinder engines / Motores 4 cilindros											
390T, 398, 698T, 1004T, 3065, 3065S, 3070	AT4.236	11	30/100-10 A=200°	4222108M91 ULPK0001	4 holes / agujeros	30/101-10 (4222125M91, ULPR0005)					
393TLX, 394TAQ, 396CT, 397T, 1007	AT4.236		30/100-8 A=140°	4222091M91 ULPK0003	4 holes / agujeros						
178, 185, 188	A4.248	10	30/100-7	4222104M91 ULPK0011	2 holes / agujeros	30/101-7 (1883344M92, 26410050)					
185, 188, 194, 285, 290, 294, 393, 394, 396C, 397, 590	A4.248	11	30/100-8 A=140°	4222091M91 ULPK0007	4 holes / agujeros	30/101-10 (4222125M91, ULPR0005)					
194, 290, 290E, 293, 294, 382N, 390, 390E, 690, 3055, 3060	A4.248		30/100-10 A=200°	4222108M91 ULPK0001	4 holes / agujeros						
285 (USA), 298, 592, 595, 698, 1004, 1080, 1085	A4.318	8	30/100-6	4222107M91 ULPK0010	2 holes / agujeros	30/101-5 (4222110M91, ULPR0004)					
4225, 4235, 4240, 6110, 6120	A4.41 (Blue)	12	30/100-32	4224451M91 ULPK0034	4 holes / agujeros						
275E, 290E, 375E, 390E	A4.41 (Blue)	11	30/100-10 A=200°	4222108M91 ULPK0001	4 holes / agujeros						
374, 3220, 3330, 4225, 4325	1004.40 (Green)	12	30/100-32	4224451M91 ULPK0034	4 holes / agujeros	30/101-10 (4222125M91, ULPR0005)					
394, 2230, 3235, 3340, 4235 (USA), 4335	1004.42 (Green)										
3075, 4245, 4255, 6130, 6140, 6150	1004.4T (Blue)										
3350, 3355, 4235, 4245, 4255, 4345, 4355, 6235, 6245, 6255	1004.40T (Green)										
4265, 4365, 6265	1004.40TW										
6 cylinder engines / Motores 6 cilindros											
1014, 1104, 1200	A6.354.1						13	30/100-9	4222093M91 ULPK0007	2 holes / agujeros	30/101-5 (4222110M91, ULPR0004)
1105, 1135	AT6.354.1										
1114 (⇒ U711699L)	A6.354.4						14	30/100-72	4223583M91 ULPK0022	4 holes / agujeros	
399, 699, 1014, 1024 1114 (U711700L ⇒) 1250, 2620, 2625, 2640, 2645, 2675, 3080, 3090, 3610	A6.354.4						15	30/100-25	4222105M91 ULPK0002	4 holes / agujeros	30/101-31 (422219M91, ULPR0002)
1134, 2680, 2685, 2705, 2720, 2725, 3630, 3650	AT6.354.4										
396, 399, 3085, 3095, 3115, 4260, 4270, 6160, 6170	1006.6 (Blue)										
3120, 3120T, 3125, 3140, 3635, 3645, 3660, 6180, 6190, 8110, 8120, 8130	1006.6T (Blue)										
4260, 4360, 6260	1006.60 (Green)										
6170, 6180, 6270, 6280, 6290, 8120, 8220	1006.60T (Green)										
4270, 4370	1006.60T (Green)	16	30/100-44	4222449M91 ULPK0015	4 holes / agujeros						

'A' is the angle between the inlet and outlet pipe. / 'A' es el ángulo entre las tuberías de entrada y salida.

Part numbers are quoted for reference purposes only.
Our parts and accessories are not original.

Las referencias originales tienen un propósito identificativo.
Nuestras piezas no son originales.



FUEL PUMPS
BOMBINES DE ALIMENTACIÓN



19



20



21



22

Tractors Tractores	Engine Motor	Fig.	Ref. Ref.	OEM	Observation Comentario
 6 cylinder engines / Motores 6 cilindros					
3690, 3690 3670, 8140, 8150	612DS 620DS	19	30/100-82	3637646M91 V835340017	Mechanical pump Bombín mecánico
8140 (H07868 ⇔) 8240	620DS 620DSRAE	20	30/100-83	V836659580	Diaphragm pump Bombín de membrana 5 holes / agujeros
8240Xtra	620DWBAE	21	30/100-84	V836340066	Mechanical pump Bombín mecánico
3690, 8160	634DS	19	30/100-82	3637646M91 V835340017	Mechanical pump Bombín mecánico
8250, 8260	634DSBAE	21	30/100-84	V836340066	Mechanical pump Bombín mecánico
8250Xtra, 8260Xtra	634DWBAE	22	30/100-85	V836362023	Mechanical pump Bombín mecánico
8170, 8180, 8270, 8280 8270Xtra, 8280Xtra	645DSBIE 645DSBAE	21	30/100-84	V836340066	Mechanical pump Bombín mecánico

SPARE PARTS / PIEZAS DE RECAMBIO



1



2



3



3

	1	2	3		3
Pump Bomba	Glass bowl Vaso de cristal	Strainer Filtro	Gasket Junta	Pump Bomba	Diaphragm Membrana
30/100-3	30/102-1 (1004498M1)	30/101-57 (1850160M1)	30/101-58 (1655042M91)	All models Todos los modelos	30/101-43M (26410089)
30/100-5					

Part numbers are quoted for reference purposes only.
Our parts and accessories are not original.

Las referencias originales tienen un propósito identificativo.
Nuestras piezas no son originales.



FUEL PUMPS
BOMBINES DE ALIMENTACIÓN

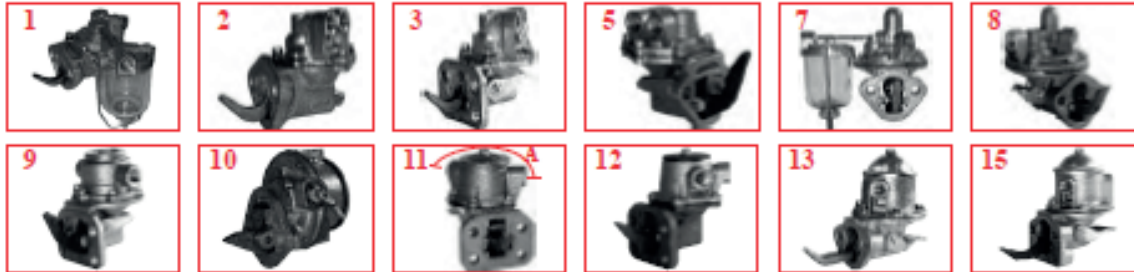

Tractors <i>Tractores</i>	Engine <i>Motor</i>	Fig.	Ref. <i>Ref.</i>	OEM	Observation <i>Comentario</i>	Repair kit <i>Juego de reparación</i>
4 cylinder engines combines / Cosechadoras motores 4 cilindros						
186	A4.212	10	30/100-7	4222104M91 ULPK0011	2 holes / agujeros	30/101-7 (1883344M92, 26410050)
99, 187	A4.236					
487, 506	A4.248					
8Plot, 10Plot, 16, 16Plot, 240, 307, 330	A4.236	11	30/100-10 A=200*	4222108M91 ULPK0001	4 holes / agujeros	30/101-10 (4222125M91, ULPR0005)
20, 430, 440, 487, 506	A4.248					
20XP	AT4.236					
400, 410	A4.300	7	30/100-5	4222452M91 ULPK0009	Glass bond <i>Víscoso de cristal</i>	30/101-5 (4222110M91, ULPR0004)
6 cylinder engines combines / Cosechadoras motores 6 cilindros						
500, 507, 510, 515, 520, 525	A6.354	13	30/100-9	4222093M91 ULPK0007	2 holes / agujeros	30/101-5 (4222110M91, ULPR0004)
24, 530, 530S, 535, 800, 805, 810, 815	A6.354.4	15	30/100-25	4222105M91 ULPK0002	4 holes / agujeros	30/101-31 (422219M91, ULPR0002)
27, 29, 29XP, 31, 31XP, 560, 565, 660, 665, 820, 825, 830, 835, 840, 845, 850, 855, 865	AT6.354.4					
750, 760	AT6.354.4					
620, 625, 740, 750	A6.372	13	30/100-9	4222093M91 ULPK0007	2 holes / agujeros	30/101-5 (4222110M91, ULPR0004)
Telescopic handlers / Carretillos elevadores telescópicos						
8925, 8925T, 8926, 8926T, 8937, 8937T, 8939, 8939T	1004.4 (Blue) 1004.42 (Green) 1004.4T (Blue) 1004.40T (Green)	12	30/100-32	4222106M91 ULPK0005	4 holes / agujeros	30/101-10 (4222125M91, ULPR0005)
4 cylinder engine industrial tractors / Palas retrocargadoras motores 4 cilindros						
203, 205	A3.152	1	30/100-3	4222094M91 ULPK0018	2 holes / agujeros	30/101-3 (4222118M91, ULPR0006)
20, 30B, 203, 205, 2135, 2203, 2205	AD3.152					
20, 20B, 20C, 20D, 20E, 30B, 30H, 203, 205, 2135, 2203, 2205	AD3.152	2	30/100-4	4222111M91 ULPK0006	2 holes / agujeros	30/101-4 (4222109M91, ULPR0003)
20B/C/D/E/F, 30B/E/H, 40	AD3.152	3	30/100-19	4222090M91 ULPK0004	4 holes / agujeros	30/101-10 (4222125M91, ULPR0005)
40E	AT3.152.4					
702	23C	5	30/100-2	1884857M91	2 holes / agujeros	
356	A4.203	7	30/100-5	4222452M91 ULPK0009	Glass bond <i>Víscoso de cristal</i>	30/101-5 (4222110M91, ULPR0004)
30, 50, 302, 304, 356, 3165, 3303, 3305	AD4.203					
40B, 50, 302, 304, 356, 3165, 3303, 3305	AD4.203	8	30/100-6	4222107M91 ULPK0010	2 holes / agujeros	
70	A4.318	9	30/100-71	4222121M91 ULPK0008	4 holes / agujeros	30/101-10 (4222125M91, ULPR0005)
40B	AD4.203					
50, 50B, 3303, 3305	A4.212					
50C	A4.236	10	30/100-7	4222104M91 ULPK0011	2 holes / agujeros	30/101-7 (1883344M92, 26410050)
50, 50B	A4.212	11	30/100-8 A=140*	4222091M91 ULPK0003	4 holes / agujeros	30/101-10 (4222125M91, ULPR0005)
50, 50B, 50B Mk11, 50C	A4.236					
30D, 50D, 50E, 50H, 50H-S, 50H-T, 60 60HX, 60HX-T	A4.236	11	30/100-10 A=200*	4222108M91 ULPK0001	4 holes / agujeros	30/101-10 (4222125M91, ULPR0005)
50EYHFNH-S/HN-T, 60H/S	AT4.236					
	A4.248					
Ferret & Terex - 4 cylinder engine industrial tractors / Palas retrocargadoras motores 4 cilindros						
750, 760, 860, 960, 965	1004.4 (Blue) 1004.4T (Blue)	12	30/100-32	4222106M91 ULPK0005	4 holes / agujeros	30/101-10 (4222125M91, ULPR0005)

*'A' is the angle between the inlet and outlet pipe. / 'A' es el ángulo entre las tuberías de entrada y salida.

Part numbers are quoted for reference purposes only.
Our parts and accessories are not original.

Las referencias originales tienen un propósito identificativo.
Nuestras piezas no son originales.



FUEL TANKS AND RELATED PARTS
DEPÓSITOS Y ACCESORIOS RELACIONADOS

Tanks / Depósitos



Tractors <i>Tractores</i>	Fig.	Ref. <i>Ref.</i>	OEM
135 <i>Standard size / Dimension estándar</i>	1	30/6099-6	897401M92
230, 240, 243, 250, 253, 263		30/6099-7	3762589M91
275, 275E, 285, 290, 290E, 375E, 390E	2	30/6099-8	3762587M91, 532300M94

TANK DAMPER
SILENT-BLOCK



30/106-2
(883623M1)

165, 168, 175, 178, 185, 188, 265, 275, 285,
290, 298, 375E, 390E

*Part numbers are quoted for reference purposes only.
Our parts and accessories are not original.*

*Part numbers are quoted for reference purposes only.
Our parts and accessories are not original.*



FUEL TANKS AND RELATED PARTS
DEPÓSITOS Y ACCESORIOS RELACIONADOS

Caps / Tapones depósitos

Tractors Tractores	Fig.	Ref. Ref.	OEM
25, 35, 35X, 65, 133, 135, 140, 145, 148, 152, 158, 165, 175, 185, 188, 230, 235, 240, 245, 250, 253, 255, 260, 263, 265, 275, 285, 290, 298, 550, 560, 575, 590, 592, 595, 675, 690, 698, 699, 765, 825, 835, 865, 1004	1	30/105-1 <i>Economy</i> <i>Economico</i>	828583M91 1876534M91
340, 342, 350, 352, 355, 360, 362, 365, 372N, 375, 382N, 390, 396, 398, 399	2	30/105-6	1695732M1
2620, 2625, 2640, 2645, 2680, 2685, 2720, 2725, 3050, 3060, 3065, 3070, 3075, 3080, 3085, 3090, 3095, 3115, 3120, 3125, 3610, 3630, 3635, 3645, 3650, 3655, 3670, 3680, 3690, 6110, 6120, 6130, 6140, 6150, 6160, 6170, 6180, 6190, 6235, 6245, 6255, 6260, 6265, 6270, 6280, 6290, 8110, 8120, 8130, 8140, 8150, 8160	3	30/105-7	3041489M4
134, 154, 174, 184, 194, 234S	4	30/105-19	1825066M92
154S, 174S, 184S, 234, 254, 274, 284, 294, 364, 1014, 1024	5	30/105-20	3300019M91



Taps / Grifos combustibles

Tractors Tractores	Fig.	Ref. Ref.	OEM
35, 35X, 65, 133, 134, 135, 140, 145, 148, 152, 155, 158, 165, 235, 245, 250, 255, 260, 765, 2620, 2625, 2640, 2645, 2680, 2685, 2720, 2725	1	30/103-1	1851653M91
133, 135, 140, 148, 230, 231, 235, 240, 245, 250, 255, 260, 261, 1200, 1250	2	30/103-2	898540M91
165, 168, 175, 178, 185, 188, 265, 275, 285, 290, 298	3	30/103-3	898580M91
Separate filter for / Filtro suelto para: 30/103-1, 30/103-2, 30/103-3	4	30/104-1	1851654M1
230, 240, 253, 263, 265, 275, 290, 340, 342, 350, 352, 355, 360, 362, 365, 372N, 375, 382N, 390, 398	5	30/103-4	1694985M92
134, 154, 174, 184, 194, 233, 234, 253, 254, 263, 264, 273, 274, 284, 293, 294	6	30/103-14	3302134M91
Separate filter for / Filtro suelto para: 30/103-14	7	30/104-3	3310087M1

THROTTLE CLIPS
GRUPILLA

30/6687-1
(894224M1)

Ø 6mm

30/6687-2
(894225M1)

Ø 5mm



Part numbers are quoted for reference purposes only.
Our parts and accessories are not original.







Las referencias originales tienen un propósito identificativo.
Nuestras piezas no son originales.



**STOP CABLES
CABLES DE PARO**

Tractors Tractores	Ref. Ref.	OEM	Length A Long. A
			
230, 240, 253 350, 355, 360, 4225, 4235, 4240, 4245, 4255 (Footstep / Con plataforma)	30/107-3	3701712M91	1010mm
340, 350, 355, 360 (With cab / Con cabina) - 362, 362N, 382N (Footstep / Con plataforma) 365, 375, 390, 390T, 398, 399	30/107-4	3701713M91	1160mm
342, 352, 365, 372N, 375, 390, 390T, 398, 399 362, 362N, 382N, 4225, 4235, 4240, 4245, 4255 (With cab / Con cabina)	30/107-5	3701714M93	1300mm
Cable to cut / Cables para cortar	30/107-22		1700mm
	30/107-23		4000mm

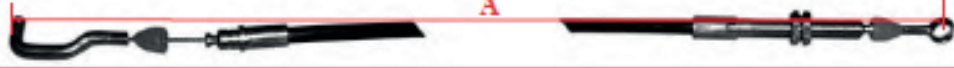
**THROTTLE CABLES
CABLES DE ACELERADOR**







Tractors Tractores	Ref. Ref.	OEM	Length A Long. A
Hand cables / Cables del acelerador de mano			
			
240, 243, 253, 263	30/108-26	3759020M92	752 mm
340, 350, 355, 360, 362, 362N, 365, 375, 382N, 390, 390T, 398 (Footstep tractors / Tractores con plataforma)	30/108-1	3759021M91	1127 mm
340, 342, 350, 352, 355, 360, 362, 362N, 372N, 382N With cab / Con cabina	30/108-2	3759022M91	1227 mm
365, 375, 390, 390T, 398 With cab / Con cabina 396, 399	30/108-3	3759023M91	1337 mm
			
3050, 3060, 3065, 3070, 3080, 3090, 3610, 3630, 3650 (⇨ N271003)	30/108-32	3388256M3	535 mm
			
3050, 3060, 3065, 3070, 3080, 3090, 3610, 3630, 3650 (N271004 ⇨ R.094049) 3680 (⇨ R.07520)	30/108-33	3581876M3	865 mm
3050, 3060, 3065, 3070, 3080, 3090, 3610, 3630, 3650 (R.094050 ⇨ S157040) 3095, 3115, 3125, 3140, 3645, 3655 (⇨ S157040) 3680 (R.07521 ⇨ S157040)	30/108-34	3615017M1	1970 mm
			
3050, 3060, 3065, 3070, 3080, 3090, 3095, 3115, 3125, 3140, 3610, 3630, 3645, 3650, 3655, 3680 (S157041 ⇨) 3075, 3085, 3120, 3120T, 3635, 3670, 3690	30/108-35	3615918M1	720 mm
			
4225, 4235, 4240, 4245, 4255, 4260, 4265, 4270 (R.37009 ⇨) 4315, 4320, 4325, 4335, 4345, 4355 With cab / Con cabina	30/108-20	3821313M91	936 mm
			
4235, 4245, 4255, 4265, 4270, 4335, 4345, 4355, 4365, 4370 With Versacab cab / Con cabina Versacab	30/108-25	3815726M91	820 mm

Part numbers are quoted for reference purposes only.
Our parts and accessories are not original.

Las referencias originales tienen un propósito identificativo.
Nuestras piezas no son originales.



**THROTTLE CABLES
CABLES DE ACELERADOR**

Tractors Tractores	Ref. Ref.	OEM	Length A Long. A
Hand cables / Cables del acelerador de mano			
			
6110, 6120, 6130, 6140, 6150, 6160, 6170, 6180, 6190, 8110, 8120, 8130, 8140, 8150, 8160 6160, 6170, 6180, 6190 Platform /Plataforma (⇒ F336031)	30/108-36	3713027M2	810 mm
			
6160, 6170, 6180, 6190 Platform /Plataforma (F336032 ⇒) 6260, 6270, 6280, 6290, 8110, 8120, 8130, 8150, 8160 Platform /Plataforma, 8170, 8180 6235, 6245, 6255, 6260, 6265, 6270, 6280, 6290, 8210, 8220, 8240, 8250, 8260, 8270, 8280 (⇒ 07/01/2001)	30/108-37	3778639M1	855 mm
			
6235, 6245, 6255, 6260, 6265, 6270, 6280, 6290, 8210, 8220, 8240, 8250, 8260, 8270, 8280 (08/01/2001 ⇒)	30/108-38	3785334M1	1270 mm
Foot cables / Cables del pedal acelerador			
			
340, 342, 350, 352, 355, 360, 362, 362N, 372N, 382N, 396, 398, 399 (Footstep tractors / Tractores con plataforma)	30/108-5	3759025M91	1057 mm
362N, 372N (Hop cab - Germany / Cabina Hop - Alemania) 365, 375, 390, 390T 396, 398, 399 (With cab / Con cabina)	30/108-4	3759024M91	977 mm
			
240, 243, 253, 263	30/108-18	3759026M91	1193mm
4215, 4220, 4225, 4235, 4240, 4245, 4255, 4265, 4315, 4320, 4325, 4335, 4345, 4365	30/108-21	3805472M91	1245mm
4260, 4270 (Blue engines / Motores azul) 4360, 4370 (Footstep tractors / Tractores paso)	30/108-22	3806378M92	1530mm
4260, 4270 (Green engines / Motores verde) 4360, 4370 (With cab / Con cabina)	30/108-23	3811818M91	1560mm
			
3050, 3060, 3065, 3070 (N271004 ⇒ S157040) 3080, 3090, 3610, 3630, 3650 (⇒ S157040) 3095, 3115, 3125, 3140, 3645, 3655, 3680 (⇒ S157040)	30/108-39	3581879M2	205 mm
			
3050, 3060, 3065, 3070 (S157041 ⇒) 3075	30/108-40	3615921M3	710 mm
3075, 3085, 3120, 3120T 3095, 3115, 3125, 3140 (S157041 ⇒) 3635 (⇒ B068030) - 3645 (S157041 ⇒ B049014) - 3655 (S157041 ⇒ B062029) 3680 (S157041 ⇒ A084025) - 3670, 3690 (⇒ A084025)	30/108-42	3615919M3	1035 mm
3080, 3090, 3610, 3630, 3650 (S157041 ⇒) - 3670, 3680, 3690 (A084026 ⇒)	30/108-43	3616931M4	1605 mm

Part numbers are quoted for reference purposes only.
Our parts and accessories are not original.

Las referencias originales tienen un propósito identificativo.
Nuestras piezas no son originales.



**THROTTLE CABLES
CABLES DE ACELERADOR**

Tractor Tractores	Ref. Ref.	OEM	Length A Long. A
Foot cables / Cables del pedal acelerador			
3120, 3120T 3635 (B068031 ⇔) - 3645 (B049015 ⇔) - 3655 (B062030 ⇔)	30/108-44	3619105M2	1085 mm
6110, 6120, 6130, 6140	30/108-45	3619375M3	615 mm
6160, 8150, 8160 6170 (⇔ F014037)	30/108-46	3713022M2	895 mm
6180 (⇔ F017008) - 8120 (⇔ F044008) - 8270 (⇔ J116025) - 8280 (⇔ J083023) 6190, 8110, 8130, 8170, 8180, 8210, 8220	30/108-47	3713025M6	955 mm
6170 (F014038 ⇔) - 6180 (F017009 ⇔) - 8120 (F044009 ⇔) 6260, 6270, 6280, 6290	30/108-48	3715973M1	890 mm
8140, 8240	30/108-49	3713440M2	1235 mm
8250, 8260, 8270 (J116026 ⇔) - 8280 (J083024 ⇔)	30/108-42	3615919M3	1035 mm
3050, 3060, 3065, 3070 (⇔ N271003)	30/108-50	3386146M3	1410 mm
3050, 3060, 3065, 3070, 3080, 3090, 3095, 3115, 3125, 3645 (S157041 ⇔) 3085, 3655 With forestry cab / Con cabina forestal	30/108-51	3616474M1	1320 mm
6150	30/108-52	3713026M2	675 mm
6235, 6245, 6255, 6265	30/108-53	3782749M1	685 mm
Centre cables / Cables centrales del acelerador			
240, 243, 253, 263, 340, 342, 350, 352, 355, 360	30/108-7	1696818M94	210 mm
362, 362N, 372N, 382N (C10425 ⇔)	30/108-16	3761360M91	220 mm
365, 375, 390, 390T, 398, 399 (1006.6) (⇔ C10424)	30/108-8	1696819M94	280 mm
365, 375, 390, 390T, 398, 399 (1006.6) (C10425 ⇔)	30/108-15	3761359M91	235 mm
396, 398, 399 (1006.6) (C10425 ⇔)	30/108-17	3761361M91	420 mm
399 (A6.354.4)	30/108-9	1696816M97	627 mm
3050, 3060, 3065, 3070 (N271004 ⇔ S157040)	30/108-54	3581877M2	1905 mm
3080, 3090, 3610, 3630, 3650 (⇔ S157040)	30/108-55	3581878M3	2310 mm
3095, 3115, 3125, 3140, 3645, 3655, 3680 (⇔ S157040)	30/108-56	3583363M1	2055 mm
Rear control - hand cable / Cables de mano, control trasero			
4215, 4220 4225, 4235, 4240, 4245, 4255, 4260, 4265, 4270 (⇔ K37008) With cab-side console / Con panel de mandos lateral	30/108-19	3805131M91	976mm
4225, 4235, 4240, 4245, 4255, 4260, 4265, 4270, 4315, 4320, 4325, 4335, 4345, 4355, 4360, 4370	30/108-24	3813027M91	700mm
<i>(Footstep tractors centre shift and side console / Tractores con plataforma)</i>			

Part numbers are quoted for reference purposes only.
Our parts and accessories are not original.

Las referencias originales tienen un propósito identificativo.
Nuestras piezas no son originales.



INJECTOR NOZZLES
TOBERAS DE INYECTOR



Tractors Tractores	Engine Motor	Ref. Ref.	Nozzle N° N°Tobera	OEM
3 cylinder engines / Motores 3 cilindros				
35, 133, 135	A3.144	30/117-3	BDLL110S6133	31990, 1851744M1 2646607, 1447252M1
35	A3.152			
135 (⇔ 203993D)	AD3.152	30/117-4	BDLL150S6372	2646676, 1853019M91
135 (203994D ⇔), 230, 233, 240, 333, 334V, 340	AD3.152	30/117-34	BDLL150S6743	2646848, 1447474M1
134, 135(Export), 140, 234, 235, 245	AD3.152	30/117-96	BDLL150S6554	2646688, 1446701M1
145, 148, 152, 154, 233, 244CF, 250, 253 (Italy), 254, 255, 342, 350, 353, 354, 550, 2205, 3210	AD3.152	30/117-35	BDLL150S6602	2646825, 1446896M1, 2645L604, 4222905M1
253(UK), 352, 355, 360, 363, 364, 366CF	AT3.152.4	30/117-36	JB6801029	2645K603, 3637320M1
2210, 3315, 4215, 4315	903-27	30/117-161	L058PBA	2645A633, 4224323M1
263(UK), 2220, 3325, 4220, 4320	903-27T	30/117-149	L068PBA	2645A637, 4222733M1
4 cylinder engines / Motores 4 cilindros				
FE35, 835	23C	30/117-12	BDN128PC6290 5651241	890007M2
25, 30, 130, 825	A4.107	30/117-31	BDN4SD6769	2646724, 1447768M1
65, 865	A4.203	30/117-3	BDL110S6133	31990, 1851744M1
65, 165(UK), 765	AD4.203	30/117-4	BDLL150S6372	2646676, 1853019M91
155, 158, 165(France)	AD4.203	30/117-96	BDLL150S6554	2646688, 1446701M1
260, 560	AD4.203	30/117-34	BDLL150S6743	2646848, 1447474M1
165, 174	A4.212	30/117-6	BDLL150S6555	2646689, 1446702M1
168, 174, 175, 184, 265, 273, 274, 275, 275E, 283, 284, 362, 362N, 365, 367CF, 372N, 373, 374, 375, 375E, 376C, 377, 383, 384, 387, 565, 575, 675, 3050, 3220, 3225	A4.236	30/117-9	BDLL150S6705	2646842, 1447227M1
390T, 393TLX, 394TAQ, 396CT, 397T, 398, 698T, 1004T, 1007, 3065, 3070	AT4.236	30/117-37	JB6801027	3637319M1, 2645K602
178, 185, 188, 194, 284, 285, 293, 294	A4.248	30/117-8	BDLL150S6556	2646690, 1446703M1
290, 290E, 382N, 390, 390E, 393, 394, 396, 397, 590, 690, 3055, 3060, 3235	A4.248	30/117-10	BDLL150S6600	2646826, 1447146M1
298, 592, 595, 698, 1004, 1080, 1085	A4.318	30/117-32	BDLL150S6599	2646824, 1446892M1
275E, 290E, 375E, 390E, 4240, 6120	A4.41	30/117-42	JB6801022	2645A604, 1447829M91
4225, 4235 (⇔ 01/01/99), 6110	A4.41	30/117-37	JB6801027	3637319M1, 2645K602
4235 (02/01/99 ⇔)	A4.41	30/117-135	6801058 JVM	2645A608, 3637195M1
374, 3220, 3330, 4225, 4235	1004.40 (Green)	30/117-154	L064PBA	2645A627, 4222292M1
394, 2230, 3235, 3340, 4235, 4335	1004.42 (Green)	30/117-146	L072PBA BVM	2645K609, 4222977M1
4245, 6130	1004.4T (Blue)	30/117-155	6801088	2645A613, 3640923M1
3075, 4255, 6140, 6150	1004.4T (Blue)	30/117-136	6801157	2645A621, 3640961M1
3350, 3355, 4235, 4245, 4345, 6235, 6245	1004.40T (Green)	30/117-151	L060PBA	2645A628, 4222230M1
4255, 4355, 6255	1004.40T (Green)	30/117-162	L063PBA	2645A635, 4223976M1
4265, 4365, 6265	1004.40T (Green)	30/117-163	L069PBA	2645K608, 4223737M1

Part numbers are quoted for reference purposes only.
Our parts and accessories are not original.

Las referencias originales tienen un propósito identificativo.
Nuestras piezas no son originales.



INJECTOR NOZZLES
TOBERAS DE INYECTOR



Tractors Tractores	Engine Motor	Ref. Ref.	Nozzle N° N°Tobera	OEM
6 cylinder engines / Motores 6 cilindros				
399, 699 (L198026 ⇔), 1014 (TW31147), 3080	A6.354.4	30/117-42	JB6801022	2645A604, 1447829M91
699 (⇔ L198025), 1014 (TW31087), 1024, 1114, 1250, 2620, 2625, 2640, 2645, 2675, 3090, 3610	A6.354.4	30/117-39	BDLL150S6730	2646844, 1447269M91
1134, 2680, 2685, 2705, 3630	AT6.354.4	30/117-41	BDLL150S6737	2646845, 1447391M1
2720, 2725, 3650	AT6.354.4	30/117-43	JB6801019	2645A603, 1447658M1
396, 399, 3085, 3095, 4260, 4270, 6160, 6170	1006.6 (Blue)	30/117-158	6801106	2645A617, 3637185M1
3115	1006.6 (Blue)	30/117-135	6801058 JVM	2645A608, 3637195M1
3120, 3120T, 6180	1006.6T (Blue)	30/117-147	2645L616	2645L616, 3640674M1
3125, 3140, 3635 (YB31245)	1006.6T (Blue)	30/117-156	6801104	2645A616, 3637148M1
3635 (YB31262), 3645 (YB31264), 6190, 8110, 8120	1006.6T (Blue)	30/117-153	29-98106	2645L605, 3640672M1
3655, 3660 (YB31263), 8130	1006.6T (Blue)	30/117-152	7-01106	2645L612, 3640673M1
3655, 3660 (YB31236, YB31247)	1006.6T (Blue)	30/117-150		2645A614, 3638262M1
4260, 4360, 6260	1006.60 (Green)	30/117-154	L064 PBA	2645A627, 4222292M1
4270, 4370, 6170, 6270	1006.60T (Green)	30/117-157	L062 PBA	2645A629, 4222191M1
6180, 6280, 6290	1006.60T (Green)	30/117-151	L060 PBA	2645A628, 4222230M1
8120, 8220	1006.60T (Green)	30/117-148	L061 PBA CVM	2645A630, 4222256M1
8210	1006.60T (Green)	30/117-164	L065PBA DVM	2645A636, 4223761M1
3680, 3690	612DS	30/117-137	DLLA150S1029	V836339087, 3637645M1
3670, 8140, 8150, 8240	620DS	30/117-170	DLLA150S620	V836639957, 3638954M1
3690, 8160	634DS			
8250, 8260	634DSBAE	30/117-160	33877 39-02	V836854792
8250Xtra, 8260Xtra	634DWB AE	30/117-165	SDLLA145M35304	V836854937
8170, 8180, 8270, 8280	645DSBIE	30/117-159	DLLA143P495	V836354611
8270Xtra, 8280Xtra	645DSBAE	30/117-166	SDLLA145M35235	V836854930

Part numbers are quoted for reference purposes only.
Our parts and accessories are not original.

Las referencias originales tienen un propósito identificativo.
Nuestras piezas no son originales.



INJECTOR NOZZLES
TOBERAS DE INYECTOR



Tractors Tractores	Engine Motor	Ref. Ref.	Nozzle N° N°Tobera	OEM
4 cylinder engines combines / Cosechadoras motores 4 cilindros				
8 Plot, 10Plot, 187, 206, 240	A4.236	30/117-9	BDLL150S6705	2646842, 1447227M1
16, 16Plot, 330	A4.236	30/117-62	BDLL150S6649	2646831, 1447235M1
20XP	AT4.236			
99, 307	A4.236	30/117-8	BDLL150S6556	2646690, 1446703M1
20, 430	A4.248	30/117-10	BDLL150S6737	2646826, 1447146M1
6 cylinder engines combines / Cosechadoras motores 6 cilindros				
507, 510, 515, 520, 525	A6.354	30/117-38	BDLL150S6472	2646679, 883258M91
24, 530 S, 530, 535, 800, 805, 810, 815	A6.354.4	30/117-39	BDLL150S6730	2646844, 1447269M91
27, 29, 29XP, 31, 31XP, 840, 845, 850, 855, 860	AT6.345.4	30/117-43	JB6801019	2645A603, 1447658M1
560, 565, 660, 665, 750, 760, 820, 825, 830, 835, 850, 855, 860	AT6.354.4	30/117-41	BDLL150S6737	2646845, 1447391M1
750	A6.372.4	30/117-39	BDLL150S6730	2646844, 1447269M91
Telescopic handlers / Carretillas elevadoras telescópicas				
8925, 8926, 8937, 8939	1004.4 (Blue)	30/117-135	6801058 JVM	2645A608, 3637195M1
	1004.42 (Green)	30/117-146	L072PBA BVM	2645K609, 4222977M1
8925T, 8926T, 8937T, 8939T (Early / Primeros)	1004.4T (Blue)	30/117-167	JB6801052	2645A606, 3637169M1
	1004.40T (Green)	30/117-168		2645A615, 3640352M1
8925T, 8926T, 8937T, 8939T (Late / Últimos)	1004.40T (Green)	30/117-162	L063PBA	2645A635, 4223976M1
3 cylinder engine industrial tractors / Palas retrocargadoras motores 3 cilindros				
203, 205, 2135, 2203, 2205 (Early / Primeros)	AD3.152	30/117-3	BDL110S6133	2646607, 1447252M1
20, 20B, 20F, 30H 30E (CE31116, CE31138, CE31182, CE31183) 40 (CE20802, CE31084) 203, 205, 2135, 2203, 2205 (Late / Últimos)	AD3.152	30/117-34	BDLL150S6743	2646848, 1447474M1
20C, 20D, 20E, 30B, 30E (CE31144, CE31184), 40 (CE22438)	AD3.152	30/117-35	BDLL150S6602	2646825, 1446896M1
40E	AT3.152.4	30/117-36	JB6801029	2645K603, 3637320M1
4 cylinder engine industrial tractors / Palas retrocargadoras motores 4 cilindros				
702	23C	30/117-12	BDN12SPC6290	890007M2
50, 356, 3165, 3303, 3305	AD4.203	30/117-4	BDLL150S6372	2646676, 1853019M91
40B, 302, 304	AD4.203	30/117-34	BDLL150S6743	2646848, 1447474M1
50, 50B, 3303, 3305	A4.212	30/117-6	BDLL150S6555	2646689, 1446702M1
30D, 50, 50B, 50BMKII, 50C/D/E/H/S/H-T	A4.236	30/117-9	BDLL150S6705	2646842, 1447227M1
60HX, 60HX-T	AT4.236	30/117-37	JB6801027	3637319M1, 2645K602
50EX, 50HX, 50HX-S, 60H, 60H-S	A4.248	30/117-8	BDLL150S6556	2646690, 1446703M1
50HX-T	A4.248	30/117-10	BDLL150S6737	2646826, 1447146M1
70	A4.318	30/117-32	BDLL150S6599	2646824, 1446892M1
Ferret & Terex - 4 cylinder engine industrial tractors / Palas retrocargadoras motores 4 cilindros				
760	1004.4 (Blue)	30/117-135	6801058 JVM	2645A608, 3637195M1
	1004.4T (Blue)			
760, 860, 960, 965	1004.40T (Green)	30/117-151	L060PBA	2645A628, 422230M1

Part numbers are quoted for reference purposes only.
Our parts and accessories are not original.

Las referencias originales tienen un propósito identificativo.
Nuestras piezas no son originales.



FUEL SYSTEM
SISTEMA DE COMBUSTIBLE

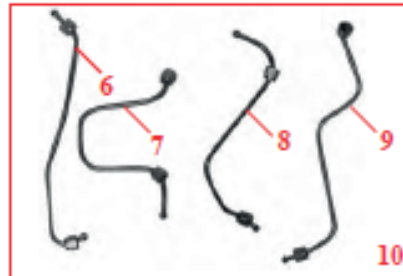
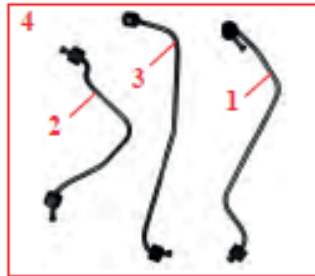

Tractors Tractores	Engine Motor	Fig.	Ref. Ref.	OEM	Observation Comentario
3 cylinder engines / Motores 3 cilindros					
133, 134, 135, 140, 145, 148, 230, 233, 234, 235, 240, 245, 250, 333, 334V, 340, 354V (⇨ 06/94)	AD3.152	1	30/127-1	35342023, 3638623M91	Pipe n°1 Tubo n°1
		2	30/127-2	35342024, 3638624M91	Pipe n°2 Tubo n°2
		3	30/127-3	35342025, 3638625M91	Pipe n°3 Tubo n°3
		4	30/125-1	B12501	3 pipe set / Juego de 3 tubos 30/127-1 + 30/127-2 + 30/127-3
4 cylinder engines / Motores 4 cilindros					
165, 174, 186	A4.212	5	30/126-2	35587344, 734723M91	Leak-off pipe Tubería de retorno del inyector
168, 174, 175, 184, 265, 273, 274, 275, 283, 284, 565, 575, 675, 187, 206, 240, 307	A4.236				
178, 185, 188, 194, 285, 290, 293, 294, 397, 590, 690 (⇨ U937344L), 440, 487, 506	A4.248				
165, 174, 186	A4.212	6	30/127-5	35343136, 3641094M91	Pipe n°1 Tubo n°1
	A4.236	7	30/127-6	35343137, 3641262M91	Pipe n°2 Tubo n°2
	AT4.236	8	30/127-7	35343138, 3641095M91	Pipe n°3 Tubo n°3
		9	30/127-8	35343139, 3641156M91	Pipe n°4 Tubo n°4
178, 185, 188, 194, 285, 290, 290E, 293, 294, 382N, 390, 390E, 393, 394, 396C, 397, 590, 690, 3060, 20, 430, 440, 487, 506	A4.248	10	30/125-2	B12502	4 pipe set / Juego de 4 tubos 30/127-5 + 30/127-6 + 30/127-7 + 30/127-8

INJECTION-HOLDER PARTS / PIEZAS PORTA INYECTORES

Ref. Ref.	Fig.	OEM	Size Dim.	Description Descripción
30/118-1	1	0920113, 826218M1	9/16" x 13/16"	Copper washer Arandela de cobre
30/118-2		0921173, 376091X1	3/8" x 13/16"	
30/113-1	2	0095315, 731567M1	5/16" UNF x 9/16"	Injector bolt Tornillo del inyector
30/114-1	3	0921176, 376518X1	5/16" x 7/16"	Copper washer Arandela de cobre



Part numbers are quoted for reference purposes only.
Our parts and accessories are not original.

Las referencias originales tienen un propósito identificativo.
Nuestras piezas no son originales.



FUEL PIPE RUBBER OLIVES
SOPORTES DE GOMA PARA TUBERLAS DE COMBUSTIBLE

By 20 pieces / Por 20 piezas



Ref. Ref.	Height Altura	Outer Ø Ø ext.	Inner Ø Ø int.	For pipe Ø Por tubo Ø	OEM
30/9156-26	6.00mm	8.00mm	4.60mm	3/16"	33811112 376524X1
30/9156-27	6.00mm	10.70mm	6.14mm	1/4"	33811113 376525X1
30/9156-28	6.00mm	10.70mm	7.74mm	5/16"	33811114 376526X1
30/9156-29	6.00mm	9.12mm	6.14mm	1/4"	33811115 376527X1
30/9156-32	Kit of 100 olives / Juego de 100 soportes 20x9156-26 + 20x 9156-29 + 30x9156-27 + 30x9156-28				

FUEL PIPES
TUBERLAS DE COMBUSTIBLE



Tractors Tractores	Fig.	Ref. Ref.	OEM	Lg.
35, 133, 135, 140, 145	1	30/109-1	890322M92	370mm
133, 135, 140, 145, 148, 152, 155, 235, 240, 245, 250, 253, 255, 263	2	30/109-2	883712M94	450mm
65, 165, 765	3	30/109-3	892130M93	440mm
168, 265, 275, 285, 290	4	30/109-4	1667052M93	795mm

CAV FILTERS
FILTROS CAV



1	2	3	4	5	6	7	8
Single filter Filtro simple	Double filter Filtro doble	Assy. less filter Soporte sin filtro	Cap Tapón sup.	Filtre Filtro	Bowl Vaso de cristal	Tube Tubo	Drain cock Tapón drenaje
30/110-301 (883786M91, 2656615)		30/110-301R	30/110-16R (1630925M1)	60/111-3 (3405418M1) Repl. / Str. CAV 296	60/112-1 (1024386M1, 26560075) Repl. / Str. CAV 7111/403	30/110-18T (1039072M1)	30/110-19 (1890150M1)
	30/110-302 (1446891M91, 2656811)	30/110-302R	30/110-17R	60/111-5 (836218M91) CAV 296	60/112-2 (1890147M1, 26560111) Repl. / Str. CAV 7111/429		

Part numbers are quoted for reference purposes only.
Our parts and accessories are not original.

Las referencias originales tienen un propósito identificativo.
Nuestras piezas no son originales.



**WATER PUMPS
BOMBAS DE AGUA**











Tractors <i>Tractores</i>	Engine <i>Motor</i>	Illustration <i>Ilustración</i>	Water pump <i>Bomba de agua</i>	Repair kit <i>Juego de rep.</i>	By-pass hose <i>Manguito deriv.</i>	Inlet hose <i>Manguito entr.</i>
3 cylinder engines / Motores 3 cilindros						
35	A3.144		Hub / Soporte Ø 62.5mm With pulley Con polea 30/130-2 (41312784)			
35	A3.152		Without pulley Sin polea 30/130-6 (U5MW0097, 3641823M91)			
135 (UK ⇔ UA5274D) 135, 140, 145 (France ⇔ FA1985D)	AD3.152			30/131-2 (38293, U7LW0105, 731774M91, 3641392M91)	30/141-3 (U5MH0006, 747936M91)	30/142-1 (U5MH0001, 747939M91)
133, 135	A3.144					
135	AG3.152					
135 (UK UA5275D ⇔) 135, 140, 145 (France FA1986D ⇔) 133, 134, 148, 150, 152, 154, 230, 233, 234, 235, 240, 244CF, 245, 250, 253 (Italy), 254, 255, 333, 334V, 340, 342, 350, 353, 354, 356CF, 550, 2205, 3210	AD3.152		Hub / Soporte Ø 79.5mm With pulley Con polea 30/130-3 (41312487)			
164T, 253 (UK), 263T (Italy), 264T, 352, 355 360 (CNB1187)	AT3.152.4		Without pulley Sin polea 30/130-6 (U5MW0097, 3641823M91)			30/142-8 (U5MH0017, 3637574M91)
360 (CNB1185), 363, 364, 366CF	AT3.152.4					

Part numbers are quoted for reference purposes only.
Our parts and accessories are not original.

Las referencias originales tienen un propósito identificativo.
Nuestras piezas no son originales.



**WATER PUMPS
BOMBAS DE AGUA**

Tractors <i>Tractores</i>	Engine <i>Motor</i>	Illustration <i>Ilustración</i>	Water pump <i>Bomba de agua</i>	Repair kit <i>Juego de rep.</i>	By-pass hose <i>Manguito deriv.</i>	Inlet hose <i>Manguito entr.</i>
4 cylinder engines / Motores 4 cilindros						
TEA20 TED20 TEH20	85mm Petrol 85mm VO 85mm LO		30/130-1 (1885489M92)	30/131-1 (894920M91)	30/141-32 (57073)	
35, 135	87mm Petrol				30/141-66 (826257M1)	
TEF20	20C Diesel				30/141-1 (60582)	
FE35, 835	23C Diesel				30/141-2 (826199M1)	
25, 122	A4.99		With pulley <i>Con polea</i> 30/130-213 (41312459)	30/131-12 (U7LW0003, 748709M91)		
25, 30, 130, 825	A4.107		Without pulley <i>Sin polea</i> 30/130-12 (U5MW0054, 748095M91)			
65	A4.192		With pulley <i>Con polea</i> 30/130-136 (41312574)	30/131-4 (U7LW0101, 3641393M91)	30/141-4 (U5MH0011, 3637426M91)	
65, 865	A4.203		Without pulley <i>Sin polea</i> 30/130-4 (U5MW0089, 3641250M91)		(⇔ UA97889D) 30/141-4 (U5MH0011, 3637426M91)	30/142-2 (U5MH0018, 747941M91)
65, 155, 158, 158MKIII, 165, 260, 560, 765	AD4-203				(UA97890D⇔) 30/141-64 (U5MH0021, 747942M91)	
165, 174	A4.212		With simple pulley <i>Con simple polea</i> 30/130-137 (41312551)	Shaft / Eje 1/2" UNF 30/131-6 (U7LW0025, 747965M91)		
168, 174, 175, 184, 255 (USA), 273, 274, 283, 284, 362, 362N, 367CF, 372N, 373, 374, 376C, 377, 383, 384, 387, 3220, 3225	A4.236		Without pulley <i>Sin polea</i> 30/130-8 (U5MW0104, 3641832M91)		Shaft / Eje 5/8" UNF 30/131-8 (U7LW0110, 3641383M91)	
178, 185, 188, 194, 293, 294, 382N, 393, 394, 396C, 397, 3235	A4.248			30/131-174 (U7LW0100, 3641283M91)		
168MKIII, 265, 275, 275E, 375E, 565, 575 675 With threaded blanking plug <i>Con toma ciega roscaada</i>	A4.236		30/130-8 (U5MW0104, 3641832M91)			
285, 290, 290E, 390E, 590 690 With threaded blanking plug <i>Con toma ciega roscaada</i>	A4.248					

Part numbers are quoted for reference purposes only.
Our parts and accessories are not original.

Las referencias originales tienen un propósito identificativo.
Nuestras piezas no son originales.



WATER PUMPS BOMBAS DE AGUA







Tractor Tractor	Engine Motor	Illustration Ilustración	Water pump Bomba de agua	Repair kit Juego de rep.	By-pass hose Manguito deriv.	Inlet hose Manguito entr.
4 cylinder engines / Motores 4 cilindros						
675 With heater outlet <i>Con salida para calentador</i>	A4.236		30/130-71 (U5MW0188, U5MW0106, 4224460M91 4222071M91)	30/131-8 (U7LW0110, 3641383M91)	30/141-11 (U5MH0024, 747944M91)	
690 With heater outlet <i>Con salida para calentador</i>	A4.248					
365, 375	A4.236				30/141-10 (U5MH0052, 3638251M91)	30/142-9 (U5MH0047, 3637573M91)
390	A4.248					
390T, 398, 698T, 1004T	AT4.236					
393TLX, 394TAQ, 396CT, 397T, 1007	AT4.236		30/130-31 (U5MW0108, 4222002M91)	30/131-31 (U7LW0096, 3641333M91)	30/141-65 (U5MH0023, 747943M91)	
3050	A4.236					
3055, 3060	A4.248				30/141-11 (U5MH0024, 747944M91)	
3065, 3065S, 3070	AT4.236					
285 (USA)	A4.318		30/130-14 (41313272, 3641363M91)			30/142-17 (U5MH0025, 747945M91)
285 (USA), 298 (UK)	A4.318.2					
592, 595, 1080, 1085	A4.318			30/131-13 (U7LW0156, 4224111M91)		30/142-3 (U5MH0026, 747946M91)
298 (France), 592, 595, 698 (⇔ 1984)	A4.318.2		30/130-13 (U5MW0147, 3641887M91)			
698 (1984 ⇔), 1004	A4.318.2					
275E, 290E, 375E, 390E	A4.41		30/130-71 (U5MW0188, U5MW0106, 4224460M91 4222071M91)	30/131-8 (U7LW0110, 3641383M91)	30/141-11 (U5MH0024, 747944M91)	
4225, 4235, 4240, 6110, 6120	A4.41 (Blue)		30/130-31 (U5MW0108, 4222002M91)	30/131-31 (U7LW0096, 3641333M91)	30/141-131 (U5MH0053, 3640921M91)	
3075, 4245, 4255, 6130, 6140, 6150	1004.4T (Blue)					
4225, 4325	1004.40 (Green)		30/130-194 (U5MW0189, 4224441M91)			
4235, 4245, 4255, 4345, 4355, 6235, 6245, 6255	1004.40T (Green)					
4235 (USA), 4335	1004.42 (Green)			30/131-198 (U7LW0173, 4224675M91)	30/141-132 (U5MH0056, 4222846M91)	
4265, 4365, 6265	1004.40TW			30/130-198 (U5MW0190, 4224475M91)		

Part numbers are quoted for reference purposes only.
Our parts and accessories are not original.

Las referencias originales tienen un propósito identificativo.
Nuestras piezas no son originales.



**WATER PUMPS
BOMBAS DE AGUA**

Tractors Tractores	Engine Motor	Illustration Ilustración	Water pump Bomba de agua	Repair kit Juego de rep.	By-pass hose Manguito deriv.	Inlet hose Manguito enr.
6 cylinder engines / Motores 6 cilindros						
1100 Later twin thermostat design <i>Vibración con termostato doble</i>	A6.354		30/130-48 (U5MTW0183, 4224118M91)	30/131-48 (U7LW0123, 3641382M91)		30/142-31 (U5MH0027, 747947M91)
1014, 1104, 1200	A6.354.1					
1105 1130 (354UA3356T ⇔) 1135	ATC6.354.1 AT6.354 AT6.354.1					
1250	A6.354.4					
2620, 2640 (⇔ 271212)	A6.354.4		30/130-49 (U5MTW0129, 3641886M91)	30/131-49 (U7LW0097, 3641332M91)	30/141-60 (U5MH0032, 747950M91)	
399, 699, 1014, 1024, 1114 2620, 2640 (271213 ⇔) 2625, 2645, 2675, 3080, 3090, 3610	A6.354.4					
1134	AT6.354.4					
2680, 2685 (U691472K ⇔) 2720, 2725, 3630, 3650	AT6.354.4					
2680 (⇔ 271212)	AT6.354.4		30/130-32 (U5MTW0133, 3641880M91)	30/131-32 (U7LW0127, 3641379M91)		30/142-16 (33855114, 3639969M1)
2680 (271213 ⇔ U691471K) 2685 (⇔ U691471K) 2705	AT6.354.4					30/141-12 (U5MH0028, 3637427M91)
396, 399, 3085, 3095, 3115, 6160, 6170	1006.6 (Blue)					30/142-30 (U5MH0029, 747948M91)
3120, 3120T, 3125, 3140, 3635, 3645, 3655, 3660, 6180, 6190, 8110, 8120, 8130	1006.6T (Blue)					30/141-12 (U5MH0028, 3637427M91)
6170, 6180	1006.60T (Green)		30/130-88 (U5MTW0128, 4222120M91)	30/131-88 (U7LW0128, 3641380M91)		30/142-16 (33855114, 3639969M1)
8120	1006.60T (Green)					30/141-12 (U5MH0028, 3637427M91)
4260, 4270	1006.6 (Blue)					30/142-16 (33855114, 3639969M1)
4260, 4360	1006.60 (Green)					30/141-12 (U5MH0028, 3637427M91)
4270, 4370	1006.60T (Green)		30/130-91 (U5MTW0092, 4222028M91)	30/131-91 (U7LW0151, 4222467M91)		30/141-133 (U5MH0050, 3637257M91)
4260, 4270	1006.6 (Blue)					30/131-197 (U7LW0148, 4222456M91)
4260, 4360	1006.60 (Green)					30/130-197 (U5MTW0156, 4222459M91)
4270, 4370	1006.60T (Green)					30/130-193 (U5MTW0159, 4223109M91)
4270, 4370	1006.60T (Green)		30/130-199 (U5MTW0160, 4222466M91)	30/131-91 (U7LW0151, 4222467M91)		30/141-133 (U5MH0050, 3637257M91)
4260, 4270	1006.6 (Blue)					30/131-197 (U7LW0148, 4222456M91)
4260, 4360	1006.60 (Green)					30/130-197 (U5MTW0156, 4222459M91)
4270, 4370	1006.60T (Green)					30/130-193 (U5MTW0159, 4223109M91)

Part numbers are quoted for reference purposes only.
Our parts and accessories are not original.

Las referencias originales tienen un propósito identificativo.
Nuestras piezas no son originales.



**WATER PUMPS
BOMBAS DE AGUA**

Tractors Tractores	Engine Motor	Illustration Ilustración	Water pump Bomba de agua	Repair kit Juego de rep.	By-pass hose Manguito deriv.	Inlet hose Manguito entr.
6 cylinder engines / Motores 6 cilindros						
6260	1006.60		30/130-194 (U5MW0189, 4224441M91)	30/131-198 (U7LW0173, 4224675M91)	30/141-132 (U5MH0056, 4222846M91)	
6270, 6280, 6290	1006.60T					
8210	1006.60T					
8220	1006.60T		30/130-198 (U5MW0190, 4224475M91)		30/141-63 (U5MH0063, 4223764M91)	
3680, 3690	612DS					
3670, 8140, 8150	620DS					
3690, 8160	634DS					
8240	620DSRAE			30/131-200 (V836339723, V836340257, 3637648M91, 3638949M91)		
8250, 8260	634DSBAE					
8240Xtra	620DWBAE					
8250Xtra, 8260Xtra	634DWBAE					
8260	634DSBIE					

**WATER PUMP SEALS
ESTOPADAS BOMBA DE AGUA**

Seal Junta	Fig.
30/131-2B (2415216, 1446130M1) Ht. / Alt. 17mm	
30/131-6S (2418M004, 3637576M1) Ht. / Alt. 22mm	

**WATER PUMP SINGLE PULLEY
POLEA SIMPLE BOMBA DE AGUA**

Tractors Tractores	Engine Motor	Poulie Polea	Fig.
165, 174, 186, 50, 50B, 3303, 3305	A4.212	30/131-8C (31146952)	
168, 174, 175, 184, 274, 274S, 187, 206, 240, 307	A4.236		
178, 185, 188, 194, 284S, 294S, 440, 487, 506	A4.248		

Part numbers are quoted for reference purposes only.
Our parts and accessories are not original.

Las referencias originales tienen un propósito identificativo.
Nuestras piezas no son originales.



**WATER PUMPS
BOMBAS DE AGUA**









Tractors <i>Tractores</i>	Engine <i>Motor</i>	Illustration <i>Ilustración</i>	Water pump <i>Bomba de agua</i>	Repair kit <i>Juego de rep.</i>	By-pass hose <i>Manguito deriv.</i>	Inlet hose <i>Manguito entr.</i>
4 cylinder engines combines / Cosechadoras motores 4 cilindros						
186	A4-212		With single pulley <i>Con simple polea</i> 30/130-137 (41312551)	Shaft / Eje 1/2" UNF 30/131-6 (U7LW0025, 747965M91)		
99, 187, 206, 240, 307	A4-236		Without pulley <i>Sin polea</i> 30/130-8 (U5MW0104, 3641832M91)	Shaft / Eje 5/8" UNF 30/131-8 (U7LW0110, 3641383M91)		
440, 487, 506	A4-248					
8 Plot, 10 Plot, 16 Plot, 16, 330	A4-236		30/130-8 (U5MW0104, 3641832M91)	30/131-174 (U7LW0100, 3641283M91)		
20, 430	A4-248					
20XP	AT4-236		30/130-71 (U5MW0188, U5MW0106, 4224460M91 4222071M91)	30/131-8 (U7LW0110, 3641383M91)	30/141-65 (U5MH0023, 747943M91)	
788	A4-270			30/131-11 (59093, 3639034M1)		
6 cylinder engines combines / Cosechadoras motores 6 cilindros						
500, 507, 510, 515, 520, 525	A6-354		30/130-10 (U5MW0111, 3641861M91)	30/131-10 (U7LW0118, 3641378M91)		

Part numbers are quoted for reference purposes only.
Our parts and accessories are not original.

Las referencias originales tienen un propósito identificativo.
Nuestras piezas no son originales.



WATER PUMPS BOMBAS DE AGUA

Tractors Tractores	Engine Motor	Illustration Ilustración	Water pump Bomba de agua	Repair kit Juego de rep.	By-pass hose Manguito deriv.	Inlet hose Manguito entr.
 6 cylinder engines combines / Cosechadoras motores 6 cilindros						
24, 27	A6.354.4		30/130-49 (U5MW0129, 3641886M91)	30/131-49 (U7LW0097, 3641332M91)	30/141-60 (U5MH0032, 747950M91)	
530, 530S, 535, 800, 805, 810, 815	A6.354.4				30/141-61 (U5MH0031, 747949M91)	
750	A6.372.4				30/141-60 (U5MH0032, 747950M91)	
29	AT6.354.4		30/130-196 (U5MW0132, 4222001M91)		30/141-62 (U5MH0033, 747951M91)	
29XP, 31, 31XP, 560, 565, 660, 665, 750, 760, 820, 825, 830, 835, 840, 845, 850, 855, 860	AT6.354.4					
 Telescopic handlers / Carretillas elevadoras telescópicas						
24	A4.236		30/130-8 (U5MW0104, 3641832M91)	30/131-8 (U7LW0110, 3641383M91)		
24T	AT4.236		30/130-31 (U5MW0108, 4222002M91)	30/131-31 (U7LW0096, 3641333M91)	30/141-11 (U5MH0024, 747944M91)	
8925, 8926, 8937, 8939	1004.4 (Blue)		30/130-90 (U5MW0157, 4223566M91)	30/131-90 (U7LW0149, 4223518M91)	30/141-133 (U5MH0050, 3637257M91)	
8925T, 8926T, 8937T, 8939T	1004.4T (Blue)					
8925, 8926, 8937, 8939	1004.42 (Green)		30/130-194 (U5MW0189, 4224441M91)	30/131-198 (U7LW0173, 4224675M91)	30/141-132 (U5MH0056, 4222846M91)	
8925T, 8926T, 8937T, 8939T	1004.40T (Green)					

Part numbers are quoted for reference purposes only.
Our parts and accessories are not original.

Las referencias originales tienen un propósito identificativo.
Nuestras piezas no son originales.



**WATER PUMPS
BOMBAS DE AGUA**

Tractors Tractores	Engine Motor	Illustration Ilustración	Water pump Bomba de agua	Repair kit Juego de rep.	By-pass hose Manguito deriv.	Inlet hose Manguito entr.
3 cylinder engine industrial tractors / Palas retrocargadoras motores 3 cilindros						
203, 205	A3.152		Support / Soporte Ø 62.5mm With pulley Con polea 30/130-2 (41312784)			
203, 205, 2135 (⇒ UA5274D)	AD3.152		Without pulley Sin polea 30/130-6 (U5MW0097, 3641823M91)	30/131-2 (58293, U7LW0105, 731774M91, 3641392M91)	30/141-3 (U5MH0006, 747936M91)	30/142-1 (U5MH0001, 747939M91)
203, 205, 2135 (UA5275D ⇒) 20, 20B, 20C, 20D, 20E, 20F, 30B, 30E, 30H, 40, 2203, 2205	AD3.152		Support / Soporte Ø 79.5mm With pulley Con polea 30/130-3 (41312487)			
20, 40	AG3.152		Without pulley Sin polea 30/130-6 (U5MW0097, 3641823M91)			
40E (CN31157, CN31158)	AT3.152.4					30/142-8 (U5MH0017, 3637574M91)
40E (CN31195, CN31196)	AT3.152.4					
4 cylinder engine industrial tractors / Palas retrocargadoras motores 4 cilindros						
702	23C Diesel		30/130-1 (1885489M92)	30/131-1 (894920M91)	30/141-2 (826199M1)	
356	A4.203		With pulley Con polea 30/130-136 (41312574)		30/141-4 (U5MH0011, 3637426M91)	
30, 40B, 50, 302, 304, 356, 3165, 3303, 3305	AD4.203		Without pulley Sin polea 30/130-4 (U5MW0089, 3641250M91)	30/131-4 (U7LW0101, 3641393M91)	(⇒ UA97889D) 30/141-4 (U5MH0011, 3637426M91) (UA97890D ⇒) 30/141-64 (U5MH0021, 747942M91)	30/142-2 (U5MH0018, 747941M91)

Part numbers are quoted for reference purposes only.
Our parts and accessories are not original.

Las referencias originales tienen un propósito identificativo.
Nuestras piezas no son originales.



WATER PUMPS
BOMBAS DE AGUA

Tractors <i>Tractores</i>	Engine <i>Motor</i>	Illustration <i>Ilustración</i>	Water pump <i>Bomba de agua</i>	Repair kit <i>Juego de rep.</i>	By-pass hose <i>Manguito deriv.</i>	Inlet hose <i>Manguito entr.</i>
3 cylinder engine industrial tractors / Palas retrocargadoras motores 3 cilindros						
50, 50B, 3303, 3305	A4.212		With simple pulley <i>Con simple polea</i> 30/130-137 (41312551)			
50, 50B, 50BMKII, 50C, 50D 50H (LD31122, LD31134) 60	A4.236		Without pulley <i>Sin polea</i> 30/130-S (USMW0104, 3641832M91)	30/131-8 (U7LW0110, 3641383M91)		
50HX, 60H (LF31128, LF31130, LF31135)	A4.248			 30/131-174 (U7LW0100, 3641283M91)		
30D, 50E, 50H (LD31163, LD31179) 50H-S, 50H-T	A4.236		30/130-S (USMW0104, 3641832M91)			
50EX 50HX, 60H (LF31164, LF31180) 50HX-S, 50HX-T, 60H-S	A4.248					
60HX, 60HX-T	AT4.236		30/130-31 (USMW0108, 4222002M91)	30/131-31 (U7LW0096, 3641333M91)	30/141-11 (USMH0024, 747944M91)	
70	A4.318		30/130-14 (41313272, 3641363M91)	30/131-13 (U7LW0156, 4224111M91)		30/142-17 (USMH0025, 747945M91)
Permec & Terex - 4 cylinder engine industrial tractors / Palas retrocargadoras motores 4 cilindros						
750	1004.4 (Blue)		30/130-31 (USMW0108, 4222002M91)	30/131-31 (U7LW0096, 3641333M91)		
760, 860, 860S, 860SE, 865, 960, 965	1004.4T (Blue)				30/141-131 (USMH0053, 3640921M91)	
750, 750B	1004.42 (Green)					
760, 760B, 860, 860B, 860S, 860SE, 960, 960B, 965	1004.40T (Green)					

Part numbers are quoted for reference purposes only.
Our parts and accessories are not original.

Las referencias originales tienen un propósito identificativo.
Nuestras piezas no son originales.



WATER PUMP HOSES
MANGUITOS PARA BOMBAS DE AGUA

Hoses (All hoses are supplied with clips) / Manguitos (Todos los manguitos son servidos con abrazaderas)

30/141-1 	30/141-2 	30/141-3 	30/141-4 
30/141-10 	30/141-11 	30/141-12 	30/141-32 
30/141-60 	30/141-61 	30/141-62 	30/141-63 
30/141-64 	30/141-65 	30/141-131 	30/141-132 
30/141-133 		30/142-1 	30/142-2 
30/142-3 	30/142-8 	30/142-9 	30/142-16 
30/142-17 	30/142-30 	30/142-31 	

Part numbers are quoted for reference purposes only.
Our parts and accessories are not original.

Las referencias originales tienen un propósito identificativo.
Nuestras piezas no son originales.



THERMOSTATS & 'V' BELTS
TERMOSTATOS Y CORREAS



Tractors <i>Tractores</i>	Engine <i>Motor</i>	Thermostat <i>Termostato</i>	Gasket <i>Junta</i>	Housing <i>Carcasa de term.</i>	Fan belt <i>Correas del ventilador</i>
3 cylinder engines / Motores 3 cilindros					
35 35	A3.144 A3.152				1175mm 1200mm 30/144-2 (A) 30/144-3 (A) (0070078, (0070106, 1851749M1) 890982M1)
135	AG3.152				30/144-3 (A) (0070106, 890982M1)
133, 135	A3.144				Dynamo / <i>Dinamo</i> 1200mm 1268mm 30/144-3 (A) 30/144-4 (A) (0070106, (0070108, 890982M1) 893575M1)
133, 135, 140, 145, 148, 150, 152	AD3.152				Dynamo / <i>Dinamo</i> - 1185mm 30/144-206 (D) (2614B143, 1447784M91) 1212mm 1235mm 30/144-100 (C) 30/144-230 (D) (2614B645, (2614B647, 3637597M1) 3637978M91)
134, 154, 233, 234, 253 (Italy), 254	AD3.152			30/146-3 (37766363, 746835M1)	1325mm 30/144-5 (A) (1876670M1)
235, 245, 250 (France), 255 240 (⇔ 513537) 550 (⇔ 620620)	AD3.152	30/143-3 (2485666, 1446165M91)	30/147-12 (36834169, 4222057M1)		1300mm 30/144-128 (D) (2614B652, 3637306M91)
240 (513538 ⇔ 522353) 550 (620621 ⇔)	AD3.152				1325mm 1275mm 30/144-21 (C) 30/144-212 (C) (2614B154, (2614B050, 1687531M1) 1688988M1)
230 240 (522354 ⇔) 250 (UK)	AD3.152				30/144-29 (C) (2614B642, 1693746M1)
244CF, 333, 334V, 340, 342, 350, 353, 354, 356CF, 220S, 3210	AD3.152				30/144-100 (C) (2614B645, 3637597M1)
264T, 263T (Italy), 264T	AT3.152.4				⇔ 13/09/01 14/09/01 ⇔ 1175mm 1200mm 30/144-29 (C) 30/144-30 (C) (2614B642, (3612115M1) 1693746M1)
253 (UK)	AT3.152.4				
352, 355 360 (CN31187)	AT3.152.4				30/144-29 (C) (2614B642, 1693746M1)
360 (CN31185) 363, 364, 366CF	AT3.152.4	30/143-18 (2485613, 1447384M1)			

(A) Single wrapped wedge belt / *Correa trapezoidal simple*
 (B) Pair of wrapped wedge belt / *Par de correas trapezoidales*
 (C) Single raw edge cogged belt / *Correa dentada simple*
 (D) Pair of raw edge cogged belts / *Par de correas dentadas*
 (E) Multi V belt / *Correas múlt V*

Part numbers are quoted for reference purposes only.
 Our parts and accessories are not original.

Las referencias originales tienen un propósito identificativo.
 Nuestras piezas no son originales.



THERMOSTATS & 'V' BELTS
TERMOSTATOS Y CORREAS

Tractors Tractores	Engine Motor	Thermostat Termostato	Gasket Junta	Fan belt Correas del ventilador	Air compressor belt Correa del compresor de aire
3 cylinder engines / Motores 3 cilindros					
263 (UK)	903.27T	30/143-18 (2485613, 1447384M1)	30/147-12 (36834169, 4222057M1)	⇒ 13/09/01 14/09/01 ⇒ Iskra altern. 1175mm 1200mm 30/144-29 (C) 30/144-30 (C) (2614B642, 3612115M1) 1693746M1)	
2210 2220	903.27 903.27T			30/144-238 (A) (3649058M1)	
3315 3325	903.27 903.27T			30/144-214 (C) (2.4119.149.0/1)	
4215, 4315 4220, 4320	903.27 903.27T			30/144-212 (C) (2614B050, 1688988M1)	
4 cylinder engines / Motores 4 cilindros					
TEA20	85mm Petrol	30/143-57 (1645921M1)		30/144-263 (A) (641696M1)	
TED20 TEH20	85mm VO 85mm LO	30/143-5 (1446127M91)			
TEF20	20C Diesel	30/143-2 (1894961M1)	30/147-13 (3910266M1)	30/144-1 (A) (826960M1)	
FE35, 835	23C Diesel			20x975mm 13x1060mm 30/144-262 (A) 30/144-264 (C) (629004M1) (828729M1)	
35	87mm Petrol			30/144-264 (C) (828729M1)	
135	87mm Petrol	30/143-3 (2485666, 1446165M91)			
25, 122 25, 30, 130, 825	A4.99 A4.107		30/147-12 (36834169, 4222057M1)	1050mm 1008mm 30/144-232 (D) 30/144-267 (C) (2614B632, 966427M1) 3639680M1)	
65 65, 865	A4.192 A4.203			1175mm 1200mm 30/144-2 (A) 30/144-3 (A) (0070078, 0070106, 1851749M1) 890982M1)	
65, 165 (UK), 765	AD4.203	30/143-4 (2485668, 1446222M91)	30/147-22 (36835442, 4223424M1)	30/144-3 (A) (0070106, 890982M1)	
155, 158, 158MKIII, 165 (Franco)	AD4.203			Дупло / Duplo Altern. 1200mm 1225mm 30/144-3 (A) 30/144-225 (D) (0070106, 3582952M1) 890982M1)	
260, 560	AD4.203			30/144-4 (A) (0070108, 893575M1)	

- (A) Single wrapped wedge belt / Correa trapezoidal simple
(B) Pair of wrapped wedge belt / Par de correas trapezoidales
(C) Single raw edge cogged belt / Correa dentada simple
(D) Pair of raw edge cogged belts / Par de correas dentadas
(E) Multi V belt / Correas multi V

Part numbers are quoted for reference purposes only.
Our parts and accessories are not original.

Las referencias originales tienen un propósito identificativo.
Nuestras piezas no son originales.



THERMOSTATS & 'V' BELTS
TERMOSTATOS Y CORREAS

Tractors Tractores	Engine Motor	Thermostat Termostato	Gasket Junta	Fan belt Correas del ventilador	Courosie compress. air Correa del compresor de aire
4 cylinder engines / Motores 4 cilindros					
165 (UK) 168 (UK), 175 (UK) 178 (UK), 185 (UK), 188 (UK)	A4.212 A4.236 A4.248			30/144-4 (A) (0070108, 893575M1)	
165 (France) 168 (France), 175 (France) 178 (France), 185 (France), 188 (France)	A4.212 A4.236 A4.248			Dушко / Душко Altern. 1232mm 1268mm 30/144-266 (A) 30/144-4 (A) (960972M1) (0070108, 893575M1)	
168MKIII	A4.236			Dушко / Душко Dушко / Душко Lucas Paris Rhone 1232mm 1268mm 30/144-266 (A) 30/144-4 (A) (960972M1) (0070108, 893575M1) Altern. 1380mm 30/144-22 (C) (2614B659, 1447778M91)	
174 174, 184 194	A4.212 A4.236 A4.248		30/147-14 (36862201, 4222011M1)	Dушко / Душко Altern. 1185mm 1212mm 30/144-206 (D) 30/144-100 (C) (2614B143, (2614B645, 1447784M91) 3637597M1)	
265 (UK), 275 (UK) 290 (UK)	A4.236 A4.248	30/143-5 (2485659, 1446127M91)		1400mm 1380mm 30/144-6 (A) 30/144-22 (C) (1669923M1) (2614B659, 1447778M91)	
265 (France), 275 (France) 285, 290 (France)	A4.236 A4.248			1400mm 1375mm 30/144-6 (A) 30/144-34 (C) (1669923M1) (3581611M1)	
273, 274, 274S, 283, 284 293, 294	A4.236 A4.248			1212mm 1185mm 30/144-100 (C) 30/144-206 (D) (2614B645, (2614B143, 3637597M1) 1447784M91)	
274SK, 284S 294S	A4.236 A4.248			1300mm 1275mm 30/144-128 (D) 30/144-229 (D) (2614B652, (2614B650, 3637306M91) 3637598M91)	
274C, 274CF 294C	A4.236 A4.248			30/144-29 (C) (2614B642, 1693746M1)	
275E, 375E 290E, 390E	A4.236 A4.248		30/147-14 (36862201, 4222011M1) LD31289, LF31255 30/147-31 (36862225, 3641893M1)	⇒ 12/02/92 13/02/92 ⇒ 1380mm 1325mm 30/144-22 (C) 30/144-21 (C) (2614B659, (2614B154, 1447778M91) 1687531M1)	

(A) Single wrapped wedge belt / Correa trapezoidal simple
(B) Pair of wrapped wedge belt / Par de correas trapezoidales
(C) Single raw edge cogged belt / Correa dentada simple
(D) Pair of raw edge cogged belts / Par de correas dentadas
(E) Multi V belt / Correas múlt V

Part numbers are quoted for reference purposes only.
Our parts and accessories are not original.

Las referencias originales tienen un propósito identificativo.
Nuestras piezas no son originales.



THERMOSTATS & 'V' BELTS
TERMOSTATOS Y CORREAS

Tractors <i>Tractores</i>	Engine <i>Motor</i>	Thermostat <i>Termostato</i>	Gasket <i>Junta</i>	Fan belt <i>Correas del ventilador</i>	Courroie compress. air <i>Correa del compresor de aire</i>
4 cylinder engines / Motores 4 cilindros					
362	A4.236	30/143-3 (2485666, 1446165M91)	30/147-15 (36834152, 3641766M1)	30/144-30 (C) (3612115M1)	
362N, 372N 382N	A4.236 A4.248			13x1200mm 30/144-30 (C) (3612115M1)	Airco / Acond. 10x1175mm 30/144-240 (D) (3761507M91)
365, 375 390 390T, 398	A4.236 A4.248 AT4.236	30/143-18 (2485613, 1447384M1)		13x1500mm 30/144-31 (C) (1693745M1)	Airco / Acond. 10x1495mm 30/144-126 (D) (1687610M91)
367CF, 373, 374, 376C, 377, 383, 384, 387, 3220, 3225	A4.236	30/143-5 (2485659, 1446127M91)	30/147-14 (36862201, 4222011M1)	⇒ 12/88 1175mm	01/89 ⇒ 1200mm
393, 394, 396C, 397, 3235	A4.248		30/147-31 (36862225, 3641893M1)	30/144-29 (C) (2614B642, 1693746M1)	30/144-233 (D) (2614B644, 3639683M1)
393TLX, 394TAQ, 396CT, 397T, 1007	AT4.236	30/143-18 (2485613, 1447384M1)	30/147-15 (36834152, 3641766M1)	30/144-234 (D) (2614B653, 3639685M1)	
565, 575 (UK) 590 (UK)	A4.236 A4.248	30/143-5 (2485659, 1446127M91)	30/147-14 (36862201, 4222011M1)	1400mm 30/144-6 (A) (1669923M1)	1380mm 30/144-22 (C) (2614B659, 1447778M91)
575 (France) 590 (France)	A4.236 A4.248			1400mm 30/144-6 (A) (1669923M1)	1375mm 30/144-34 (C) (3581611M1)
675 (UK) 690 (UK)	A4.236 A4.248	30/143-3 (2485666, 1446165M91)		30/144-22 (C) (2614B659, 1447778M91)	
675 (France) 690 (France)	A4.236 A4.248			13x1375mm 30/144-34 (C) (3581611M1)	Airco / Acond. 10x1387mm 30/144-208 (D) (1686614M91)
698T 1004T	AT4.236 AT4.236		30/147-15 (36834152, 3641766M1)	30/144-126 (D) (1687610M91)	30/144-210 (C) (1686837M1)
3050	A4.236	30/143-18 (2485613, 1447384M1)		13x1375mm 30/144-34 (C) (3581611M1)	Airco / Acond. 10x1375mm 30/144-35 (D) (3383044M91)
3055, 3060	A4.248			30/144-35 (D) (3383044M91)	30/144-290 (C) (1690692M1, 3581635M1)
3065, 3065S, 3070	AT4.236				

- (A) Single wrapped wedge belt / *Correa trapezoidal simple*
 (B) Pair of wrapped wedge belt / *Par de correas trapezoidales*
 (C) Single rrv edge cogged belt / *Correa dentada simple*
 (D) Pair of rrv edge cogged belts / *Par de correas dentadas*
 (E) Multi V belt / *Correas multi V*

Part numbers are quoted for reference purposes only.
Our parts and accessories are not original.

Las referencias originales tienen un propósito identificativo.
Nuestras piezas no son originales.



THERMOSTATS & 'V' BELTS
TERMOSTATOS Y CORREAS

Tractors <i>Tractores</i>	Engine <i>Motor</i>	Thermostat <i>Termostato</i>	Gasket <i>Junta</i>	Fan belt <i>Correas del ventilador</i>	Compressor air <i>Correa del compresor de aire</i>
4 cylinder engines / Motores 4 cilindros					
298 (UK)	A4.318.2	30/143-3 (2485666, 1446165M91)	30/147-15 (36834152, 3641766M1)	30/144-209 (D) (1686616M91)	
298 (Franca), 592, 595	A4.318 A4.318.2			30/144-13 (A) (1809095M2)	
698, 1004	A4.318.2			⇔ 1984 1984 ⇔ 12.5x1518mm 10x1495mm 30/144-13 (A) 30/144-126 (D) (1809095M2) (1687610M91)	
1080 (Franca)	A4.318			Paris-Rhone Delco Remy 1535mm 1518mm 30/144-265 (B) 30/144-13 (A) (906424M2) (1809095M2)	
1080 (USA)	A4.318			30/144-257 (C) (516467M1)	30/144-269 (C) (522063M1)
1085 (USA)	A4.318			30/144-299 (D) (529900M91)	
275E, 290E, 375E, 390E	A4.41			30/143-18 (2485613, 1447384M1)	
374, 3220	1004.40 (Green)	30/143-55 (2485C036, 4224639M1)	30/147-16 (3683R009, 4222986M1)	30/144-237 (C) (3648900M1)	
394, 3235	1004.42 (Green)				
2230	1004.42			30/144-275 (C) (3651229M1)	
3075	1004.4T	30/143-18 (2485613, 1447384M1)	30/147-15 (36834152, 3641766M1)	30/144-228 (D) (3619356M91)	Sankyo - 1050mm 30/144-290 (C) (3581635M1) Sanden - 1025mm 30/144-270 (C) (3712531M1)
3330 3340 3350, 3355	1004.40 1004.42 1004.40T	30/143-55 (2485C036, 4224639M1)	30/147-16 (3683R009, 4222986M1)	30/144-295 (C) (2.4119.139.0)	
4225, 4235, 4240	A4.41 (Blue)	30/143-18 (2485613, 1447384M1)	30/147-15 (36834152, 3641766M1)	45A, 80A 120A&Aimo/Arcad 13x1385mm 10x1385mm 30/144-247 (C) 30/144-248 (D) (3808704M1) (3808705M1)	30/144-294 (C) (3809174M1)
4245, 4255	1004.4T (Blue)				
4225HV, 4235HV	A4.41 (Blue)			45A, 80A 120A&Aimo/Arcad 13x1275mm 10x1275mm 30/144-212 (C) 30/144-251 (D) (2614B050, 3810420M91)	30/144-227 (C) (3614715M2)
4245HV, 4255HV	1004.4T (Blue)				

- (A) Single wrapped wedge belt / *Correa trapezoidal simple*
 (B) Pair of wrapped wedge belt / *Par de correas trapezoidales*
 (C) Single raw edge cogged belt / *Correa dentada simple*
 (D) Pair of raw edge cogged belts / *Par de correas dentadas*
 (E) Multi V belt / *Correas múltiple V*

Part numbers are quoted for reference purposes only.
Our parts and accessories are not original.

Las referencias originales tienen un propósito identificativo.
Nuestras piezas no son originales.



THERMOSTATS & 'V' BELTS
TERMOSTATOS Y CORREAS

Tractors <i>Tractores</i>	Engine <i>Motor</i>	Thermostat <i>Termostato</i>	Gasket <i>Junta</i>	Fan belt <i>Correas del ventilador</i>	Corroio compress. air <i>Correa del compresor de aire</i>
4 cylinder engines / Motores 4 cilindros					
4225, 4235	1004.40 (Green)	30/143-55 (2483C036, 4224639M1)	⇨ U933891D Gasket / Junta 30/147-17 (3684N017, 4222851M1) U933892D ⇨ 'O' Ring 30/147-18 (2415H492, 4223842M1)	45A, 80A 120A & Aisco / Aisco 1410mm 1400mm 30/144-252 (C) 30/144-254 (D) (3815255M2) (3817582M1)	30/144-211 (C) (1686883M1)
4235 (USA), 4335	1004.42 (Green)				
4235, 4245, 4255, 4345, 4355	1004.40T (Green)				
4265, 4365	1004.40TW (Green)				
4225HV, 4325HV	1004.40 (Green)				
4235HV (USA), 4335HV	1004.42 (Green)				
4235HV, 4245HV, 4255HV, 4345HV, 4355HV	1004.40T (Green)				
6110, 6120	A4.41	30/143-18 (2485613, 1447384M1)	30/147-15 (36834152, 3641766M1)	30/144-228 (D) (3619356M91)	30/144-270 (C) (3712531M1)
6130, 6140, 6150	1004.4T				
6235	1004.40T	30/143-55 (2483C036, 4224639M1)	⇨ U933891D Gasket / Junta 30/147-17 (3684N017, 4222851M1) U933892D ⇨ 'O' Ring 30/147-18 (2415H492, 4223842M1)	70A 80A 1475mm 1425mm 30/144-101 (D) 30/144-245 (D) (3780608M91) (3780606M91)	30/144-222 (C) (3389525M1)
6235HV	1004.40T			70A 80-120A 1345mm 1325mm 30/144-246 (D) 30/144-244 (D) (3780616M91) (3780605M91)	30/144-225 (C) (3582952M1)
6245, 6255	1004.40T			70-80A 120A 1425mm 1410mm 30/144-245 (D) 30/144-243 (D) (3780606M91) (3780138M91)	30/144-222 (C) (3389525M1)
6245HV, 6255HV	1004.40T			70-120A - Iskra 80-120A - Valeo 1325mm 1300mm 30/144-244 (D) 30/144-292 (D) (3780605M91) (3780603M91)	30/144-225 (C) (3582952M1)
6265	1004.40TW			70A 80A 1410mm 1425mm 30/144-243 (D) 30/144-245 (D) (3780138M91) (3780606M91)	30/144-222 (C) (3389525M1)
				120A 1400mm 30/144-293 (D) (3780607M91)	

- (A) Single wrapped wedge belt / *Correa trapezoidal simple*
 (B) Pair of wrapped wedge belt / *Par de correas trapezoidales*
 (C) Single rrv edge cogged belt / *Correa dentada simple*
 (D) Pair of rrv edge cogged belts / *Par de correas dentadas*
 (E) Multi V belt / *Correas multi V*

Part numbers are quoted for reference purposes only.
 Our parts and accessories are not original.

Las referencias originales tienen un propósito identificativo.
 Nuestras piezas no son originales.



THERMOSTATS & 'V' BELTS
TERMOSTATOS Y CORREAS

Tractors <i>Tractores</i>	Engine <i>Motor</i>	Thermostat <i>Termostato</i>	Gasket <i>Junta</i>	Fan belt <i>Correas del ventilador</i>	Compressor air <i>Correa del compresor de aire</i>
6 cylinder engines / Motores 6 cilindros					
1100 1130 Single thermostat pump <i>Bomba de 1 termostato</i>	A6.354 AT6.354	30/143-4 (2485668, 1446222M91)	30/147-15 (36834152 3641766M1)	1450mm 1485mm 30/144-125 (D) 30/144-37 (D) (1688216M91) (3617180M91)	30/144-258 (C) (321110M1)
1100 1130 Double thermostat pump <i>Bomba de termostatos</i>	A6.354 AT6.354	30/143-3 (2485666, 1446165M91)			
1105 1135	ATC6.354.1 AT6.354.1				
1014	A6.354.1	And / y 30/143-18 (2485613, 1447384M1)		30/144-101 (D) (2614B166, 1447695M91, 3780608M91)	
1104	A6.354.1			30/144-235 (D) (2614B668, 3639692M1)	
1200	A6.354.1			30/144-231 (D) (2614A171, 3639674M1)	
399	A6.354.4			30/144-33 (D) (3595070M91)	30/144-290 (C) (1690692M1, 3581635M1)
699	A6.354.4			30/144-125 (D) (1688216M91)	30/144-211 (C) (1686883M1)
1014 (TW31087)	A6.354.4			1325mm 1512mm 30/144-298 (D) 30/144-102 (D) (2614B654, (2614B669, 3639686M1) 1447418M91)	
1014 (TW31147) 1024	A6.354.4			1485mm 1512mm 30/144-236 (D) 30/144-102 (D) (2614B667, (2614B669, 3640473M1) 1447418M91)	
1114	A6.354.4	30/143-18 (2485613, 1447384M1)	30/147-19 (36861757, 4222906M1)	1485mm 1525mm 30/144-236 (D) 30/144-36 (D) (2614B667, (2614B670, 3640473M1) 3381364M91)	
1250	A6.354.4			30/144-204 (D) (2614B656, 1447407M91)	
2620, 2625	A6.354.4			30/144-13 (C) (1809095M2)	
2640 (⇔ 271212)	A6.354.4			Altern. 1008mm Fan / Ventil. 1485mm 30/144-267 (C) 30/144-37 (D) (966427M1) (3617180M91)	General Motors 1165mm 30/144-221 (C) (3386214M1)
2640 (271213 ⇔)	A6.354.4			Altern. 1008mm Fan / Ventil. 1485mm 30/144-267 (C) 30/144-37 (D) (966427M1) (3617180M91)	Sankyo 1100mm 30/144-211 (C) (1686883M1)
2645	A6.354.4			Altern. & Fan / Altern. & Ventil. 1525mm 30/144-36 (D) (3381364M91)	
				30/144-36 (D) (3381364M91)	

- (A) Single wrapped wedge belt / *Correa trapezoidal simple*
 (B) Pair of wrapped wedge belt / *Par de correas trapezoidales*
 (C) Single raw edge cogged belt / *Correa dentada simple*
 (D) Pair of raw edge cogged belts / *Par de correas dentadas*
 (E) Multi V belt / *Correas múlt V*

Part numbers are quoted for reference purposes only.
 Our parts and accessories are not original.

Las referencias originales tienen un propósito identificativo.
 Nuestras piezas no son originales.



THERMOSTATS & 'V' BELTS
TERMOSTATOS Y CORREAS

Tractors Tractores	Engine Motor	Thermostat Termostato	Gasket Junta	Fan belt Correas del ventilador	Corroie compres. air Correa del compresor de aire		
6 cylinder engines / Motores 6 cilindros							
2675	A6.354.4	30/143-18 (2485613, 1447384M1)	30/147-19 (36861757, 4222906M1)	Altern. 1008mm 30/144-267 (C) (966427M1)	Fan / Ventil. 1485mm 30/144-37 (D) (3617180M91)	30/144-296 (C) (3323729M1)	
3080, 3090, 3610	A6.354.4			30/144-36 (D) (3361364M91)	30/144-211 (C) (1686883M1)		
1134	AT6.354.4			1525mm 30/144-36 (D) (2614B670, 3381364M91)	1562mm 30/144-103 (D) (2614B673, 4223957M91)		
2680	AT6.354.4				General Motors 1165mm 30/144-221 (C) (3386214M1)		
2685, 2720, 2725	AT6.354.4			30/144-37 (D) (3617180M91)	Sankey 1100mm 30/144-211 (C) (1686883M1)		
2705	AT6.354.4				30/144-296 (C) (3323729M1)		
3630, 3650	AT6.354.4				30/144-211 (C) (1686883M1)		
396, 399	1006.6			30/144-36 (D) (3361364M91)	30/144-227 (C) (3614715M2)		
3085, 3095, 3115	1006.6			30/144-37 (D) (3617180M91)	30/144-225 (D) (3382952M1)		
3120, 3120T	1006.6T			30/144-124 (D) (3619084M91)			
3125, 3140, 3635 3645 (YB31246)	1006.6T			30/144-127 (D) (3582953M91)	Sankey - 1165mm 30/144-221 (C) (3386214M1)		
3645 (YB31233)	1006.6T			30/144-271 (D) (3617178M91)			
3645 (YB31264) 3655, 3660	1006.6T			30/144-123 (D) (3616512M91)	Sanden - 1025mm 30/144-270 (C) (3712531M1)		
4260, 4270	1006.6 (Blue)			30/147-20 (3684A004, 3638700M1)	120 A 1410mm 30/144-249 (D) (3808730M1)	1425mm 30/144-242 (D) (3779379M91)	30/144-250 (C) (3809175M1)
4260, 4360	1006.60 (Green)				30/144-37 (D) (3617180M91)		
4270, 4370	1006.60T (Green)						
6160, 6170	1006.6 (Blue)						
6170	1006.60T (Green)		30/144-272 (C) (3714894M1)				
6180	1006.6T (Blue)	Valeo 1465mm 30/144-124 (D) (3619084M91)	Magneti Marelli 1485mm 30/144-37 (D) (3617180M91)				
6180	1006.60T (Green)						

- (A) Single wrapped wedge belt / Correa trapezoidal simple
(B) Pair of wrapped wedge belt / Par de correas trapezoidales
(C) Single rrv edge cogged belt / Correa dentada simple
(D) Pair of rrv edge cogged belts / Par de correas dentadas
(E) Multi V belt / Correas multi V

Part numbers are quoted for reference purposes only.
Our parts and accessories are not original.

Las referencias originales tienen un propósito identificativo.
Nuestras piezas no son originales.



THERMOSTATS & 'V' BELTS
TERMOSTATOS Y CORREAS

Tractors <i>Tractores</i>	Engine <i>Motor</i>	Thermostat <i>Termostato</i>	Gasket <i>Junta</i>	Fan belt <i>Correas del ventilador</i>	Compressor air <i>Correa del compresor de aire</i>
6 cylinder engines / Motores 6 cilindros					
6190, 8110	1006.6T	30/143-18 (2485613, 1447384M1)	30/147-20 (3684A004, 3638700M1)	30/144-127 (D) (3582953M91)	30/144-221 (C) (3386214M1)
8120, 8130	1006.6T (Blue)			30/144-123 (D) (3616512M91)	
8120	1006.60T (Green)				
6260	1006.60	30/143-55 (2485C036, 4224639M1)	30/147-17 (3684N017, 4222851M1)	1425mm 120 A Iskra 1410mm 30/144-245 (D) 30/144-243 (D) (3780606M91) (3780138M91)	
6270, 6280	1006.60T	Pneum. brake <i>Freno neum.</i> 30/143-60 (2485C034, 4224624M1)	Pneum. brake <i>Freno neum.</i> 30/147-18 (2415H492, 4223842M1)	30/144-243 (D) (3780138M91)	
6290	1006.60T	30/143-60 (2485C034, 4224624M1)	30/147-18 (2415H492, 4223842M1)	30/144-37 (D) (3617180M91)	
8210, 8220	1006.60T	30/143-60 (2485C034, 4224624M1)	30/147-18 (2415H492, 4223842M1)		
3680	612DS	79° 30/143-56 (3637650M1, V836015156)	30/147-29 (V836329632)		30/144-290 (C) (3581635M1)
3690	612DS			Sankyo - 1050mm 30/144-290 (C) (3581635M1)	
3670	620DS			30/144-129 (D) (3617184M91)	Sanden - 1085mm 30/144-222 (C) (3389525M1)
3690	634DS			1025mm 30/144-270 (C) (3712531M1)	
8140, 8150	620DS				
8160	634DS				
8240	620DSRAE				
8240Xtra	620DWBAE				
8250, 8260	634DSBAE				
8250Xtra	634DWBAE				
8260	634DSBIE				
8260Xtra	634DWBAE				
8170, 8180	645DSBIE				
8270, 8280	645DSBIE				
8270Xtra, 8280Xtra	645DSBAE				
			30/147-30 (V836855603)	1485mm 1015mm 30/144-37 (D) 30/144-256 (C) (3617180M91) (5016260M1)	30/144-222 (C) (3389525M1)
				1525mm 918mm 30/144-36 (D) 30/144-241 (C) (3381364M91) (3778975M2)	30/144-221 (C) (3386214M1) 30/144-270 (C) (3712531M1)
				30/144-300 (E) (3777243M1, V836859262)	30/144-301 (C) (3582951M1)
				30/144-277 (E) (V685121905, V836864164)	30/144-221 (C) (3386214M1) 30/144-270 (C) (3712531M1)

- (A) Single wrapped wedge belt / *Correa trapezoidal simple*
 (B) Pair of wrapped wedge belt / *Par correas trapezoidal simple*
 (C) Single raw edge cogged belt / *Correa dentada simple*
 (D) Pair of raw edge cogged belts / *Par de correas dentadas*
 (E) Multi V belt / *Correas multi V*

Part numbers are quoted for reference purposes only.
 Our parts and accessories are not original.

Las referencias originales tienen un propósito identificativo.
 Nuestras piezas no son originales.



THERMOSTATS & 'V' BELTS
TERMOSTATOS Y CORREAS

Tractors Tractores	Engine Motor	Thermostat Termostato	Gasket Junta	Fan belt Correas del ventilador	Compress. air Correa del compresor de aire
4 cylinder engines combines / Cosechadoras motores 4 cilindros					
186	A4.212	30/143-5 (2485659, 1446127M91)	30/147-14 (36862201, 4222011M1)	30/144-4 (A) (0070108, 893575M1)	
99, 187	A4.236	30/143-3 (2485666, 1446165M91)			
206, 307 487, 506	A4.236 A4.248	30/143-5 (2485659, 1446127M91)			Dуmno / Dывно 1268mm Altern. 1320mm 30/144-4 (A) (0070108, 893575M1) 30/144-207 (A) (1604464M1)
240 440	A4.236 A4.248				30/144-207 (A) (1604464M1)
8 Plot, 10 Plot, 16 Plot, 16, 330 430	A4.236 A4.248	30/143-3 (2485666, 1446165M91)			
20	A4.248	78° ⇒ U792122H 30/143-4 (2485668, 1446222M91) 82° U792123H ⇒ 30/143-3 (2485666, 1446165M91)	30/147-15 (36834152, 3641766M1)	1275mm 30/144-229 (D) (2614B650, 3637598M91)	
20XP	AT4.236	30/143-18 (2485613, 1447384M1)			
788	A4.270	30/143-3 (2485666, 1446165M91)	30/147-12 (36834169, 4222057M1)		
400, 410, 415	A4.300	30/143-4 (2485668, 1446222M91)		30/144-4 (A) (0070108, 893575M1)	
6 cylinder engines combines / Cosechadoras motores 6 cilindros					
24, 27 29	A6.354.4 AT6.354.4	30/143-18 (2485613, 1447384M1)	30/147-19 (36861757, 4222906M1)	Altern. 1350mm 30/144-204 (D) (2614B656, 1447407M91) Fan / Ventil. 1332mm 30/144-268 (C) (D41999100)	
29XP, 31, 31XP	AT6.354.4			Altern. 1337mm 30/144-273 (D) (2614B655, 3639687M1) Fan / Ventil. 1332mm 30/144-268 (C) (D41999100)	
500, 510, 515	A6.354			30/144-4 (A) (0070108, 893575M1)	
507, 520, 525	A6.354	30/143-4 (2485668, 1446222M91)		Dуmno / Dывно 1268mm 30/144-4 (A) (0070108, 893575M1) Altern. 1300mm 30/144-128 (D) (2614B652, 3637306M91)	
530, 535	A6.354.4			30/144-204 (D) (2614B656, 1447407M91)	30/144-220 (A) (3372217M1)
530S	A6.354.4	30/143-18 (2485613, 1447384M1)	30/147-19 (36861757, 4222906M1)	Altern. 1350mm 30/144-204 (D) (2614B656, 1447407M91) Fan / Ventil. 1235mm 30/144-219 (D) (3049010M91)	
800, 805, 810, 815	A6.354.4				30/144-216 (A) (3036278M1)

(A) Single wrapped wedge belt / Correa trapezoidal simple - (B) Pair of wrapped wedge belt / Par de correas trapezoidales
(C) Single raw edge cogged belt / Correa dentada simple - (D) Pair of raw edge cogged belts / Par de correas dentadas
(E) Multi V belt / Correas multi V

Part numbers are quoted for reference purposes only.
Our parts and accessories are not original.

Las referencias originales tienen un propósito identificativo.
Nuestras piezas no son originales.



THERMOSTATS & 'V' BELTS
TERMOSTATOS Y CORREAS

Tractors <i>Tractores</i>	Engine Motor	Thermostat <i>Termostato</i>	Gasket <i>Junta</i>	Fan belt <i>Correas del ventilador</i>	Courosic compres. air <i>Correas del compresor de aire</i>	
6 cylinder engines combines / Cosechadoras motores 6 cilindros						
560, 565, 660, 665	AT6.354.4	30/143-18 (2485613, 1447384M1)	30/147-19 (36861757, 4222906M1)	Altern. 1325mm 30/144-21 (C) (2614B154, 1687531M1)	Fan / Ventil. 1235mm 30/144-219 (D) (3049010M91)	30/144-220 (A) (3372217M1)
820, 825, 830, 835, 840, 845	AT6.354.4			30/144-216 (A) (3036278M1)		
620, 625	A6.372			30/144-205 (D) (2614A149, 1447773M91)		
750	AT6.354.4 A6.372.4			Altern. 10x1318mm 30/144-260 (D) (532779M92)	Altern. 13x1325mm 30/144-21 (C) (1687531M1)	
760, 850, 855, 860	AT6.354.4			Altern. 1325mm 30/144-21 (C) (1687531M1)	Altern. 1375mm 30/144-259 (C) (525832M1)	
4 cylinder engine industrial tractors / Palas retrocargadoras motores 4 cilindros						
702	23C Diesel	30/143-2 (1894961M1)	30/147-13 (3910266M1)	30/144-1 (A) (826960M1)		
356	A4.203	30/143-4 (2485668, 1446222M91)	30/147-22 (36835442, 4223424M1)	1175mm 1200mm 30/144-2 (A) 30/144-3 (A) (0070078, (0070106, 1851749M1) 890982M1)		
30, 40B, 50, 302, 304, 356, 3165, 3303, 3305	AD4.203	30/143-18 (2485613, 1447384M1)	30/147-14 (36862201, 4222011M1)	30/144-3 (A) (0070106, 890982M1)		
50, 50B, 3303, 3305	A4.212			30/144-128 (D) (2614B652, 3637306M91)		
30D	A4.236			30/144-22 (C) (2614B659, 1447778M91)		
50	A4.236			30/144-6 (A) (1669923M1)		
50B, 50B MKII, 50D, 50H	A4.236			1300mm 1275mm 30/144-128 (D) 30/144-229 (D) (2614B652, (2614B650, 3637306M91) 3637598M91)		
50E 50EX	A4.236 A4.248			35 A 55 A 1400mm 1325mm 30/144-6 (A) 30/144-21 (C) (1669923M1) (2614B154, 1687531M1)		
50HX, 60H	A4.248			30/144-229 (D) (2614B650, 3637598M91)		
50H-S 50HX-S, 60H-S	A4.236 A4.248			30/147-15 (36834152, 3641766M1)	30/144-21 (C) (2614B154, 1687531M1)	
50H-T 50HX-T	A4.236 A4.248				30/144-21 (C) (2614B154, 1687531M1)	
60HX, 60HX-T	AT4.236				30/144-22 (C) (2614B659, 1447778M91)	
Ferrec & Terex - 4 cylinder engine industrial tractors / Palas retrocargadoras motores 4 cilindros						
750	1004.4 (Blue)	30/143-18 (2485613, 1447384M1)	30/147-15 (36834152, 3641766M1)	13x1375mm 13x1380mm 30/144-223 (C) 30/144-261 (C) (3516195M2) (6100645M1)	960mm 30/144-297 (C) (3522468M3)	
760, 860, 860S, 860SE, 865, 960, 965	1004.4T (Blue)	30/143-55 (2485C036, 4224639M1)	30/147-16 (3683R009, 4222986M1)	Airco / Acond. 10x1325mm 30/144-224 (C) (3522485M3)	975mm 30/144-274 (C) (6102366M1)	
750, 750B	1004.42 (Green)					
760, 760B, 860, 860B, 860S, 860SE, 960, 960B, 965	1004.40T (Green)					

Part numbers are quoted for reference purposes only.
Our parts and accessories are not original.

Las referencias originales tienen un propósito identificativo.
Nuestras piezas no son originales.



THERMOSTATS & 'V' BELTS
TERMOSTATOS Y CORREAS

Tractors Tractores	Engine Motor	Thermostat Termostato	Gasket Junta	Fan belt Correas del ventilador	Compressor air Correa del compresor de aire
Telescopic handlers / Carretillas elevadoras telescópicas					
24	A4.236	30/143-5 (2485659, 1446127M91)	30/147-14 (36862201, 4222011M1)	30/144-212 (C) (2614B050, 1688968M1)	
24T	AT4.236		30/147-15 (36834152, 3641766M1)		
8925, 8926	1004.4 (Blue)	30/143-18 (2485613, 1447384M1)	30/147-21 (3687W017, 4222405M1)	1200mm 1180mm 30/144-233 (D) 30/144-255 (C) (2614B644, (4233305M1) 3639683M1)	
8925T, 8926T	1004.4T (Blue)				
8925, 8926	1004.42 (Green)				
8925T, 8926T	1004.40T (Green)	30/143-55 (2485C036, 4224639M1)	30/147-18 (2415H492, 4223842M1)	1235mm 1180mm 30/144-230 (D) 30/144-255 (C) (2614B647, (4233305M1) 3637978M91)	
8937, 8939	1004.4 (Blue)	30/143-18 (2485613, 1447384M1)	30/147-21 (3687W017, 4222405M1)	30/144-233 (D) (2614B644, 3639683M1)	
8937T, 8939T	1004.4T (Blue)				30/144-279 (C) (4234437M1)
8937, 8939	1004.42 (Green)				
8937T, 8939T	1004.40T (Green)	30/143-55 (2485C036, 4224639M1)	30/147-18 (2415H492, 4223842M1)	30/144-255 (C) (4233305M1)	
3 cylinder engine industrial tractors / Palas retrocargadoras motores 3 cilindros					
					Housing Soporte
203, 205	A3.152			1175mm 1200mm 30/144-2 (A) 30/144-3 (A) (0070078, (0070106, 1851749M1) 890982M1)	
20, 40, 203, 205, 2135, 2203, 2205	AD3.152			30/144-3 (A) (0070106, 890982M1)	
20B (- 855893), 20D	AD3.152	30/143-3 (2485666, 1446165M91)	30/147-12 (36834169, 4222057M1)	1325mm 1300mm 30/144-5 (A) 30/144-128 (D) (1876670M1) (2614B652, 3637306M91)	30/146-3 (37766363, 746835M1)
20B (855894 -), 20C, 20E, 30B	AD3.152			30/144-21 (C) (2614B154, 1687531M1)	
20F, 30E, 30H	AD3.152			35 A 55 A 1325mm 1175mm 30/144-21 (C) 30/144-29 (C) (2614B154, (2614B642, 1687531M1) 1693746M1)	
40E	AD3.152.4			30/144-29 (C) (2614B642, 1693746M1)	

- (A) Single wrapped wedge belt / Correa trapezoidal simple
(B) Pair of wrapped wedge belt / Par de correas trapezoidales
(C) Single rrv edge cogged belt / Correa dentada simple
(D) Pair of rrv edge cogged belts / Par de correas dentadas
(E) Multi V belt / Correas multi V

Part numbers are quoted for reference purposes only.
Our parts and accessories are not original.

Las referencias originales tienen un propósito identificativo.
Nuestras piezas no son originales.



THERMOSTATS & 'V' BELTS TERMOSTATOS Y CORREAS

Tractors Tractores	Engine Motor	Thermostat Termostato	Gasket Junta	Fan belt Correas del ventilador	Compressor belt Correa del compresor de aire
4 cylinder engine industrial tractors / Palas retrocargadoras motores 4 cilindros					
702	23C Diesel	30/143-2 (1894961M1)	30/147-13 (3910266M1)	30/144-1 (A) (826960M1)	
356	A4.203	30/143-4 (2485668, 1446222M91)	30/147-22 (36835442, 4223424M1)	1175mm 1200mm 30/144-2 (A) 30/144-3 (A) (0070078, (0070106, 1851749M1) 890982M1)	
30, 40B, 50, 302, 304, 356, 3165, 3303, 3305	AD4.203			30/144-3 (A) (0070106, 890982M1)	
50, 50B, 3303, 3305	A4.212	30/143-18 (2485613, 1447384M1)		30/144-128 (D) (2614B652, 3637306M91)	
30D	A4.236			30/144-22 (C) (2614B659, 1447778M91)	
50	A4.236			30/144-6 (A) (1669923M1)	
50B, 50B MKII, 50D, 50H	A4.236		30/147-14 (36862201, 4222011M1)	1300mm 1275mm 30/144-128 (D) 30/144-229 (D) (2614B652, (2614B650, 3637306M91) 3637398M91)	
50E 50EX	A4.236 A4.248	30/143-5 (2485659, 1446127M91)		35 A 35 A 1400mm 1325mm 30/144-6 (A) 30/144-21 (C) (1669923M1) (2614B154, 1687531M1)	
50HX, 60H	A4.248			30/144-229 (D) (2614B650, 3637398M91)	
50H-S 50HX-S, 60H-S	A4.236 A4.248			30/144-21 (C) (2614B154, 1687531M1)	
50H-T 50HX-T	A4.236 A4.248	30/143-3 (2485666, 1446165M91)	30/147-15 (36834152, 3641766M1)		
60HX, 60HX-T	AT4.236	30/143-18 (2485613, 1447384M1)		30/144-22 (C) (2614B659, 1447778M91)	
Ferret & Terex - 4 cylinder engine industrial tractors / Palas retrocargadoras motores 4 cilindros					
750	1004.4 (Blue)	30/143-18 (2485613, 1447384M1)	30/147-15 (36834152, 3641766M1)	13x1375mm 13x1380mm 30/144-223 (C) 30/144-261 (C) (3516195M2) (6100645M1)	960mm 30/144-297 (C) (3522468M3)
760, 860, 860S, 860SE, 865, 960, 965	1004.4T (Blue)				
750, 750B	1004.42 (Green)	30/143-55 (2485C036, 4224639M1)	30/147-16 (3683R009, 4222986M1)	Airco / Acond. 10x1325mm 30/144-224 (C) (3522485M3)	975mm 30/144-274 (C) (6102366M1)
760, 760B, 860, 860B, 860S, 860SE, 960, 960B, 965	1004.40T (Green)				

- (A) Single wrapped wedge belt / Correa trapezoidal simple
(B) Pair of wrapped wedge belt / Par de correas trapezoidales
(C) Single raw edge cogged belt / Correa dentada simple
(D) Pair of raw edge cogged belts / Par de correas dentadas
(E) Multi V belt / Correas multi V

Part numbers are quoted for reference purposes only.
Our parts and accessories are not original.

Las referencias originales tienen un propósito identificativo.
Nuestras piezas no son originales.



**FAN BLADES
VENTILADORES**



Tractors Tractores	Engine Motor	Fig.	Steel Acero	Diameter Diámetro	Plastic Plástico	Fig.			
133, 135	A3.144	1	Front / Delantera 30/145-6 (897051M1) Rear / Trasero 30/145-5 (897050M1)	15 1/2" 394 mm 2 x 2 blades 2 x 2 palas					
133, 134, 135, 140, 145, 148, 150, 152, 154, 230, 233, 234, 235, 240, 244CF, 245, 250, 253 (Italy), 254, 255, 333, 334V, 340, 342, 350, 353, 354, 356CF, 550, 2205, 2210	AD3.152								
164T, 253 (UK), 263T (Italy), 264T, 352, 355, 360, 363, 364, 366CF	AT3.152.4								
243	903.27								
65, 155, 158, 158MKIII, 165, 260, 560, 765	AD4.203								
165, 174	A4.212				3	Front / Delantera 30/145-7 (894729M1) Rear / Trasero 30/145-8 (894730M1)	16" 406 mm 2 x 2 blades 2 x 2 palas	30/145-12 16" 406 mm 8 blades 8 palas	
168, 168MKIII, 174, 175, 184, 265, 273, 274, 275, 283, 294S, 565, 575, 675	A4.236								
178, 185, 188, 194, 285, 293, 294S	A4.248								
174, 265, 273, 274, 275, 275E, 283, 284, 375E, 675	A4.236								
184, 194, 290, 290E, 293, 294, 390E, 394C, 394H, 590, 690	A4.248								
275E, 290E, 375E, 390E	A4.41	2	30/145-9 (1874995M92, 001651U91)	16" 406 mm 6 blades 6 palas					

**HOSE CLIPS
ABRAZADERAS DE MANGUITO**

Ref. Ref.	OEM	Ø Adjustment / Adjuste		Ref. Ref.	OEM	Ø Adjustment / Adjuste	
		mm	Inch / pulg.			mm	Inch / pulg.
70/2940-012	338612X1	9,5 - 12	3/8 - 1/2	70/2940-060	338617X1 3307666M91 3638398M1	45 - 60	1 3/4 - 2 1/8
70/2940-022	3019564X1	16 - 22	5/8 - 7/8	70/2940-070	338618X1 3307667M91 3638399M1 3638339M1	55 - 70	2 - 2 3/4
70/2940-025	3641405M1	18 - 25	3/4 - 1	70/2940-080	1440860X1	60 - 80	2 1/8 - 3 1/8
70/2940-030	3638805M1 4223580M1	22 - 30	7/8 - 1 1/8	70/2940-090	3010156X1	70 - 90	2 3/4 - 3 1/2
70/2940-035	338614X1	25 - 35	1 - 1 1/8	70/2940-100	338620X1 3010158X1	85 - 100	3 1/4 - 4
70/2940-040	338615X1 364125X1 394301X1 3638378M1	30 - 40	1 1/8 - 1 3/8	70/2940-120	338622X1 3010159X1	90 - 120	3 3/4 - 4 1/2
70/2940-050	338616X1 3307850M91 3638379M1	35 - 50	1 1/4 - 1 3/4	70/2940-140	338623X1 3010161X1	120 - 140	4 1/2 - 5 1/2
70/2940-055	376831X1	40 - 55	1 1/2 - 2 1/8	70/2940-160	338624X1 3010162X1	140 - 160	5 1/2 - 6 1/4



Part numbers are quoted for reference purposes only.
Our parts and accessories are not original.

Las referencias originales tienen un propósito identificativo.
Nuestras piezas no son originales.



RADIATORS & HOSES
RADLADORES Y MANGUITOS



Tractors <i>Tractores</i>	1 Radiator <i>Radlador</i>	2 Cap <i>Tapón</i>	3 Drain tap <i>Grifo de drenaje</i>	4 Top Hose <i>Manguito sup.</i>	5 Bottom hose <i>Manguito inf.</i>
French, UK & USA tractors / Tractores franceses, ingleses y americanos					
TEA20, TED20, TEH20 85mm Petrol VO & LO	30/150-76 (9583)	30/151-1 (3638322M1)	30/55-2 (1851095M2, 31419M)	30/153-1 (1568)	30/154-113 (7126) 30/154-1 (2413)
TEF 20C Diesel	30/150-1 (9617)			30/153-2 (827496M1)	30/154-2 (826988M1)
FE35 23C Diesel	30/150-2 (894357M92)			30/154-6 (826775M1)	30/154-3 (828147M1)
35 87mm Petrol	30/150-3 (894319M92)	30/151-2 (3475308M1)		30/153-3 (890195M1)	30/154-6 (826775M1)
35 A3.144 & A3.152				30/153-6 (827930M1)	30/154-227 (897765M1)
65, 765, 865				30/153-227 (897765M1)	30/154-227 (897765M1)
135 87mm Petrol	30/150-106 (897188M94)	7 Lbs LR 30/151-2 (3475308M1)			30/154-4 (1869514M1)
133, 135, 140, 145, 148, 152 (France) 135 (UK AD3.152 ⇨ 148524)	30/150-4 (1660499M92)	10 Lbs LR 30/151-3 (3637301M1)		30/153-11 (1869514M1)	30/154-5 (1860374M2)
135 (UK AD3.152 148525 ⇨) 148 (UK)				30/153-111 (906502M1)	30/154-114 (906503M1)
155, 158, 158MKIII		30/151-2 (3475308M1)		30/153-7 (898064M1)	30/154-7 (898065M1)
165 (AD4.203)	30/150-9 (897358M4)			30/153-9 (899144M1)	30/154-9 (898748M1)
165 (UK A4.212)		30/151-3 (3637301M1)			
165MKIII (France A4.212) 168	30/150-10 (885580M3)			30/153-8 (894793M1)	30/154-8 (898745M1)
175	30/150-8 (894808M2)	30/151-2 (3475308M1)			
178 (⇨ 724936)				30/153-9 (899144M1)	30/154-9 (898748M1)
175S, 185	30/150-10 (885580M3)	30/151-3 (3637301M1)			30/154-10 (885563M1)
178 (724937 ⇨), 188					30/154-5 (1860374M2)
230, 240, 250	30/150-15 (1680547M92)	10 Lbs Round / Redondo 30/151-8 (1874445M93)			30/154-228 (3599573M3)
230, 240 (Hydrostatic steering / Dirección hidrostática) 253 (2WD)	30/150-90 (3599709M92)	10 Lbs SR 30/151-14 (180224M92)		30/153-11 (1869514M1)	30/154-5 (1860374M2)
235, 245, 255	30/150-89 (1660655M92)				30/154-229 (3698937M1)
253 (4WD)		30/151-14 (180224M92)			

Part numbers are quoted for reference purposes only.
Our parts and accessories are not original.

Las referencias originales tienen un propósito identificativo.
Nuestras piezas no son originales.



RADIATORS & HOSES
RADLADORES Y MANGUITOS



Tractors Tractores	1 Radiator Radlador	2 Cap Tapón	3 Drain tap Grifo de drenaje	4 Top Hose Manguito sup.	5 Bottom hose Manguito inf.
French, UK & USA tractors / Tractores franceses, ingleses y americanos					
260		30/151-8 (1874445M93)	30/55-2 (1851095M2, 31419M)	30/153-111 (906502M1)	30/154-114 (906503M1)
263 (2WD)				30/153-228 (3774344M1)	30/154-230 (3774635M1)
263 (4WD)		30/151-14 (180224M92)		30/153-11 (1869514M1)	30/154-231 (3774636M1)
265 275 (France 2WD)	30/150-12 (1876606M4)				30/154-9 (898748M1)
265 (South Africa) 275 (UK 2WD) 275E, 375E (A4.236)				30/153-9 (899144M1)	
275 (France 4WD)					30/154-10 (885563M1)
275 (UK 4WD 221522 ⇔)	30/150-16 (3820620M91)			30/153-130 (1692004M1)	
275E, 375E (A4.41 2WD)		30/151-8 (1874445M93)		30/153-229 (3820492M1)	30/154-9 (898748M1)
275E, 375E (A4.41 4WD)				30/153-230 (3820083M1)	
285	30/150-12 (1876606M4)			30/153-9 (899144M1)	
290 (⇔ 387020)					30/154-10 (885563M1)
290 (387021 ⇔) 290E, 390E (A4.248)	30/150-16 (3820620M91)		30/55-2 (1851095M2, 31419M)	30/153-130 (1692004M1)	
290E, 390E (A4.41)				30/153-230 (3820083M1)	
298 (France)	30/150-91 (1680734M91)			30/153-66 (1669805M1)	30/154-66 (1669806M1)
340, 342, 350, 352, 355, 360				30/153-38 (1696559M1)	30/154-38 (1694711M3)
362				30/153-39 (3611652M1)	30/154-39 (1695868M1)
362N, 372N, 382N	30/150-92 (3700447M92)			30/153-231 (3700507M1)	
365, 375, 390, 390T, 398		30/151-14 (180224M92)		30/153-40 (3596204M1)	30/154-40 (1695562M1)
399 (A6.354.4 Footstep / Con plataforma)	30/150-19 (1695721M2)			30/153-41 (1695563M1)	30/154-41 (1695564M1)
399 (A6.354.4 With cab / Con cabina)					
396, 399 (1006.6 (Blue))	30/150-93 (3614476M91)			30/153-232 (3614420M2)	30/154-232 (3614419M1)

Part numbers are quoted for reference purposes only.
Our parts and accessories are not original.

Las referencias originales tienen un propósito identificativo.
Nuestras piezas no son originales.



RADIATORS & HOSES
RADLADORES Y MANGUITOS



Tractors <i>Tractores</i>	1 Radiator <i>Radlador</i>	2 Cap <i>Tapón</i>	3 Drain tap <i>Grifo de drenaje</i>	4 Top Hose <i>Manguito sup.</i>	5 Bottom hose <i>Manguito inf.</i>
French, UK & USA tractors / Tractores franceses, ingleses y americanos					
550				30/153-11 (1869514M1)	30/154-11 (1662089M1)
560				30/153-111 (906502M1)	30/154-114 (906503M1)
565	30/150-12 (1876606M4)	30/151-8 (1874445M93)	30/55-2 (1851095M2, 31419M)	30/153-9 (899144M1)	30/154-9 (898748M1)
575	30/150-13 (1876608M3)				30/154-10 (885563M1)
590	30/150-14 (1874964M94)				
592, 595, 595MKII		30/151-19 (531505M91)		30/153-64 (1671076M1)	30/154-64 (520309M91)
675 (UK)					30/154-9 (898748M1)
675 (France 4WD)	30/150-16 (3820620M91)			30/153-65 (1681509M1)	30/154-10 (885563M1)
690 Platform / Plataforma					
690	30/150-94 (1680599M92)	30/151-14 (180224M92)	30/55-2 (1851095M2, 31419M)	30/153-66 (1669805M1)	30/154-66 (1669806M1)
698, 1004					
698T, 1004T	30/150-91 (1680734M91)				
699				30/153-68 (1692871M1)	
1080 (France)		30/151-19 (531505M91)		30/153-64 (1671076M1)	30/154-64 (520309M91)
1080 (USA)				30/153-233 (522078M1)	
1085				30/153-64 (1671076M1)	
1250					
2620, 2720		30/151-14 (180224M92)			
2640, 2680 (S134208 ⇔ S217212)				30/153-69 (3052205M1)	30/154-69 (3040882M92)
2640, 2680 (S217213 ⇔)					
2625, 2645, 2685, 2725		30/151-15 (968816M2)			
3050, 3060, 3065 (⇔ B246028)	30/150-81 (3382797M91)			30/153-43 (3382976M2)	30/154-43 (3382984M1)
3050, 3060, 3065 (B246029 ⇔)	30/150-58 (3618630M92)				30/154-233 (3618643M1)
		30/151-14 (180224M92)			
3050HV, 3060HV, 3065HV				30/153-143 (3618474M3)	30/154-234 (3618477M4)
3065S (⇔ B355024)	30/150-83 (3618290M91)	30/151-15 (968816M2)			30/154-43 (3382984M1)
				30/153-43 (3382976M2)	30/154-233 (3618643M1)
3065S (B355025 ⇔)	30/150-57 (3618632M92)	30/151-14 (180224M92)			

Part numbers are quoted for reference purposes only.
Our parts and accessories are not original.

Las referencias originales tienen un propósito identificativo.
Nuestras piezas no son originales.



RADIATORS & HOSES
RADLADORES Y MANGUITOS



	1	2	3	4	5
Tractors Tractores	Radiator Radlador	Cap Tapon	Drain tap Grifo de drenaje	Top Hose Manguito sup.	Bottom hose Manguito inf.
French, UK & USA tractors / Tractores franceses, ingleses y americanas					
3070 (⇨ 07/93)	30/150-82 (3382795M93)	30/151-15 (968816M2)		30/153-44 (3382977M1)	30/154-44 (3384380M1)
3070 (07/93 ⇨)	30/150-59 (3618628M92)	30/151-14 (180224M92)			30/154-245 (3618642M1)
3075				30/153-134 (3619057M1)	30/154-133 (3619055M1)
3080, 3090	30/150-82 (3382795M93)	30/151-15 (968816M2)		30/153-45 (3387747M1)	30/154-45 (3382965M1)
3085, 3095, 3120, 3120T (⇨ B249025) 3115 (⇨ 07/93)				30/153-132 (3582179M2)	30/154-236 (3582909M1)
3085, 3095, 3120, 3120T (B249026 ⇨) 3115 (07/93 ⇨)	30/150-59 (3618628M92)	30/151-14 (180224M92)			30/154-237 (3618641M1)
3125 (⇨ B249037) 3140		30/151-15 (968816M2)		30/153-131 (3582178M1)	30/154-238 (3581959M1)
3125 (B249038 ⇨)	30/150-60 (3618626M92)	30/151-14 (180224M92)			30/154-239 (3618640M1)
3610, 3630, 3650				30/153-69 (3052205M1)	30/154-69 (3040882M92)
3635 (⇨ B249037), 3645 (⇨ B249039), 3655 (⇨ B062028), 3660		30/151-15 (968816M2)			30/154-238 (3581959M1)
3655 (B062029 ⇨ B284012)				30/153-131 (3582178M1)	
3635 (B249038 ⇨), 3645 (B249040 ⇨), 3655 (B284013 ⇨)	30/150-61 (3619008M92)				30/154-131 (3619026M1)
3670, 3680, 3690				30/153-234 (3389736M1)	30/154-130 (3580014M1)
4215, 4220				Ø 32mm 30/153-140 (3811653M1)	30/154-139 (3811654M1)
4215, 4220 4315, 4320 (With cab / Con cabina)				Ø 37mm 30/153-235 (3817514M1)	
4225, 4235, 4240, 4245, 4255 (Blue engines) - Footstep / Con plataforma) (With cab / Con cabina) (⇨ J01274)		30/151-14 (180224M92)			30/154-137 (3807509M1)
4225, 4235, 4240, 4245, 4255 (Blue engines) With cab / Con cabina (J01275 ⇨ K37008)	30/150-129 (3810188M92)			30/153-138 (3807508M1)	30/154-240 (3818834M2)
4225, 4235, 4240, 4245, 4255 (Blue engines) With cab / Con cabina (K37009 ⇨)					30/154-241 (3820313M1)
4225, 4235, 4240, 4245, 4255 (Green engines) 4325, 4335, 4345, 4355					30/154-136 (3801168M1)

Part numbers are quoted for reference purposes only.
Our parts and accessories are not original.

Las referencias originales tienen un propósito identificativo.
Nuestras piezas no son originales.



RADIATORS & HOSES
RADLADORES Y MANGUITOS



Tractors <i>Tractores</i>	1 Radiator <i>Radilador</i>	2 Cap <i>Tapón</i>	3 Drain tap <i>Grifo de drenaje</i>	4 Top Hose <i>Manguito sup.</i>	5 Bottom hose <i>Manguito inf.</i>
French, UK & USA tractors / Tractores franceses, ingleses y americanos					
4225HV, 4235HV, 4245HV, 4255HV <i>(Blue engines)</i>				30/153-139 (3809505M1)	30/154-138 (3810344M1)
4225HV, 4235HV, 4245HV, 4255HV <i>(Green engines)</i>					
4325HV, 4335HV, 4345HV, 4355HV					
4260, 4270, 4360, 4370	30/150-110 (3808159M2)			30/153-137 (3801167M1)	30/154-136 (3801168M1)
4265, 4365				30/153-138 (3807508M1)	
6110, 6120, 6130, 6140	30/150-58 (3618630M92)			30/153-133 (3619056M1)	30/154-132 (3619054M1)
6110HV, 6120HV, 6130HV, 6140HV				30/153-143 (3618474M3)	30/154-134 (3777203M1)
6150	30/150-59 (3618628M92)			30/153-134 (3619057M1)	30/154-133 (3619055M1)
6160, 6170, 6180		30/151-14 (180224M92)		30/153-132 (3582179M2)	30/154-237 (3618641M1)
6190	30/150-61 (3619008M92)			30/153-131 (3582178M1)	30/154-131 (3619026M1)
6235, 6245, 6255, 6260					
6265, 6270, 6280, 6290	30/150-128 (3781116M1)			30/153-138 (3807508M1)	30/154-136 (3801168M1)
6235HV, 6245HV, 6255HV				30/153-139 (3809505M1)	
8110, 8130 8120 <i>(Blue engines)</i>	30/150-61 (3619008M92)			30/153-131 (3582178M1)	30/154-131 (3619026M1)
8120 <i>(Green engines)</i>					
8140, 8150, 8160				30/153-135 (3713189M2)	30/154-130 (3580014M1)
8170, 8180				30/153-136 (3777260M2)	30/154-135 (3778088M1)

Part numbers are quoted for reference purposes only.
Our parts and accessories are not original.

Las referencias originales tienen un propósito identificativo.
Nuestras piezas no son originales.



RADIATORS & HOSES
RADLADORES Y MANGUITOS



Tractor: Tractores	Radiator / Radiador		Cap Tapón	Top Hose Manguito sup.	Bottom hose Manguito inf.	
	Temperate Templado	Tropical				
IT Italian tractors / Tractores italianos						
134C, 154, 154C	30/150-49 (1824627M93)		30/151-29 (1824628M91)	30/153-114 (1824633M1)	30/154-209 (1824634M2)	
134V, 154V				30/153-241 (3530346M1)	30/154-249 (3530397M1)	
154F (Early / Primeros modelos)	30/150-112 (3660549M92)			30/153-236 (3303316M1)	30/154-209 (1824634M2)	30/154-249 (3530397M1)
154F (Late / Últimos modelos)						
154S (Early / Primeros modelos)					30/154-209 (1824634M2)	30/154-242 (3308585M1)
154S (Late / Últimos modelos)						
164TF, 164TS	30/150-112 (3660549M92)	30/150-113 (3660548M92)		30/153-241 (3530346M1)	30/154-249 (3530397M1)	
164TV				30/153-114 (1824633M1)	30/154-213 (1824637M1)	
174, 174C, 184, 194, 194C (Early / Primeros modelos)	30/150-49 (1824627M93)			30/153-114 (1824633M1)	30/154-210 (1424533M2)	
174, 174C, 184, 194, 194C (Late / Últimos modelos)					30/154-243 (3550411M2)	
174F, 184F	30/150-114 (3308187M99)	30/150-113 (3660548M92)		30/153-236 (3303316M1)	30/154-210 (1424533M2)	
174S, 184S (Early / Primeros modelos)	30/150-112 (3660549M92)				30/154-243 (3550411M2)	
174S, 184S (Late / Últimos modelos)					30/154-243 (3550411M2)	
174V, 194S					30/154-209 (1824634M2)	
194F	30/150-114 (3308187M99)	30/150-115 (3380480M99)			30/154-242 (3308585M1)	
233, 253 (Early / Primeros modelos)	30/150-49 (1824627M93)			30/153-114 (1824633M1)	30/154-210 (1424533M2)	
234C, 234S, 254, 254C, 254S					30/154-243 (3550411M2)	
233, 253 (Late / Últimos modelos)	30/150-116 (3307942M97)	30/150-117 (3380481M99)		30/153-218 (1427274M1)	30/154-211 (1427275M1)	
234CF, 244CF, 254CF, 263T, 264T, 264TCF, 264TS						30/154-244 (3308583M1)
273, 274C, 274SK, 283, 284, 293, 294 (Early / Primeros modelos)	30/150-49 (1824627M93)					
274, 274S						
273, 274C, 274SK, 283, 284, 293, 294 (Late / Últimos modelos)	30/150-116 (3307942M97)	30/150-117 (3380481M99)				
274CF, 294C						
284S	30/150-49 (1824627M93)					
294S (Early / Primeros modelos)						
294S (Late / Últimos modelos)	30/150-116 (3307942M97)					

Part numbers are quoted for reference purposes only.
Our parts and accessories are not original.

Las referencias originales tienen un propósito identificativo.
Nuestras piezas no son originales.



RADIATORS & HOSES
RADLADORES Y MANGUITOS



Tractors <i>Tractores</i>	1 <i>Radistor / Radñador</i>		2 <i>Cap Tapón</i>	3 <i>Top Hose Manguito sup.</i>	4 <i>Bottom hose Manguito inf.</i>
	Temperate <i>Templado</i>	Tropical			
IT Italian tractors / Tractores italianos					
333, 353, 353LX, 353S	Curli 30/150-116 (3307942M97) Fira 30/150-125 (3546937M91)			30/153-114 (1824633M1)	30/154-242 (3308585M1)
334V				30/153-241 (3530346M1)	30/154-249 (3530397M1)
354AQ, 354F, 354FQ, 354S, 354SQ, 354 AP/FP/GE/SP	30/150-112 (3551641M92, 3557706M93, 3660549M92)			30/153-236 (3303316M1)	30/154-242 (3308585M1)
354, 3210 FP(X)/GE(X)/SP(X) 356CF				30/153-241 (3530346M1)	30/154-249 (3530397M1)
354V (06/94 ⇔)				30/153-237 (3552207M1)	30/154-246 (3550890M1)
354 VQ (07/94 ⇔) 354V (Footstep / Con plataforma)					
363, 363LX, 363S, 364CF	Curli 30/150-116 (3307942M97) Fira 30/150-125 (3546937M91)	30/150-117 (3308481M99)	30/151-29 (1824628M91)	30/153-114 (1824633M1)	30/154-242 (3308585M1)
364AQ, 364F, 364FQ, 364S, 364SQ, 364 AP/FP/GE/SP, 366CF	30/150-112 (3551641M92, 3557706M93, 3660549M92)	30/150-113 (3551414M93, 3557707M94, 3660548M92)		30/153-236 (3303316M1)	
364V (06/94 ⇔)				30/153-241 (3530346M1)	30/154-249 (3530397M1)
364 VQ (07/94 ⇔) 364V (Footstep / Con plataforma)				30/153-237 (3552207M1)	30/154-246 (3550890M1)
367CF			30/150-114 (3308187M99)		30/153-236 (3303316M1)
373, 373LX, 373S, 376C, 376CF, 376XCF, 383, 383LX, 383S	Curli 30/150-116 (3307942M97) Fira 30/150-125 (3546937M91)	30/150-117 (3308481M99)		30/153-114 (1824633M1)	30/154-243 (3550411M2)

Part numbers are quoted for reference purposes only.
Our parts and accessories are not original.

Las referencias originales tienen un propósito identificativo.
Nuestras piezas no son originales.



RADIATORS & HOSES
RADLADORES Y MANGUITOS



Drainstop/Grifo de drenaje
30/55-2
(1851095M2,
31419M)



Tractors <i>Tractores</i>	1 Radiator / <i>Radlador</i>		2 Cap <i>Tapón</i>	3 Top Hose <i>Manguito sup.</i>	4 Bottom hose <i>Manguito inf.</i>	
	Temperate <i>Templado</i>	Tropical				
II Italian tractors / <i>Tractores italianos</i>						
374F, 374S, 384F, 384S	30/150-112 (3551641M92, 3557706M93, 3660549M92)	30/150-113 (3551414M93, 3557707M94, 3660548M92)	30/151-29 (1824628M91)	30/153-236 (3303316M1)	30/154-243 (3550411M2)	
374V (⇒ B28075)				30/153-238 (3530396M1)		
374V (B28076 ⇒)	30/150-114 (3308187M99)					
374, 384 AP/FP/GE/SP 374, 384 AQ/FQ/SQ (⇒ 02/05/97)						
374, 384 AQ/FQ/SQ (03/05/97 ⇒)						
374, 3220 AP(X)/FP(X)/GE(X)/SP(X) (Blue engines) 384, 3225 AP(X)/FP(X)/GE(X)/SP(X)		30/150-113 (3551414M93, 3557707M94, 3660548M92)				30/154-126 (3649081M1)
374, 3220 AP(X)/FP(X)/GE(X)/SP(X) (Green engines)						
374VQ, 384VQ 374V, 384V (Footstep / <i>Con plataforma</i>)	30/150-113 (3551414M93, 3557707M94, 3660548M92)	Curli 30/150-115 (3658635M92) Fira 30/150-126 (3557708M94)				30/154-243 (A) (3550411M2) 30/154-247 (B) (3551425M91)
377	Without A/C <i>Sin acond.</i> Curli 30/150-116 (3307942M97)	30/150-117 (3308481M99)			30/153-236 (3303316M1)	
387, 397	Fira 30/150-125 (3546937M91) Without A/C <i>Sin acond.</i> 30/150-117 (3308481M99)	Without A/C <i>Sin acond.</i> Curli 30/150-117 (3308481M99) With A/C <i>Con acond.</i> Fira 30/150-119 (3547503M95)				30/154-243 (3550411M2)

(A) Temperate climate without A/C / *Clima templado sin aire acondicionado*

(B) Temperate climate with A/C or tropical climate with and without A/C / *Clima templado con aire acondicionado o clima tropical*

Part numbers are quoted for reference purposes only.
Our parts and accessories are not original.

Las referencias originales tienen un propósito identificativo.
Nuestras piezas no son originales.



RADIATORS & HOSES
RADLADORES Y MANGUITOS



Tractors Tractores	1 Radiator / Radfador		2	3	4	
	Temperate Templado	Tropical	Cap Tapon	Top Hose Manguito sup.	Bottom hose Manguito inf.	
II Italian tractors / Tractores italiano						
393, 393LX, 393S, 394C, 396C, 396CF	Curli 30/150-116 (3307942M97) Fira 30/150-125 (3546937M91)	30/150-117 (3308481M99)	30/151-29 (1824628M91)	30/153-114 (1824633M1)		
393TLX, 396CT	30/150-119 (3547503M95)			30/153-239 (3545853M1)	30/154-243 (3550411M2)	
394F, 394H, 394S 394AQ, 394FQ, 394SQ (⇨ 02/05/97)	30/150-114 (3308187M99)	30/150-115 (3308480M99)				
394 AP/FP/GE/SP		Curli 30/150-115 (3658635M92) Fira 30/150-126 (3557708M94)		30/153-236 (3303316M1)	30/154-126 (3649081M1)	
394 AQ/FQ/SQ (03/05/97 ⇨) 394, 3235 AP(X)/FP(X)/GE(X)/SP(X) (Blue engines)	30/150-113 (3551414M93, 3557707M94, 3660548M92)			30/153-239 (3545853M1)	30/154-243 (3550411M2)	
394, 3235 AP(X)/FP(X)/GE(X)/SP(X) (Green engines)						
394TAQ	30/150-120 (3648755M91)					
397T, 1007	Without A/C / Sin acond. 30/150-121 (3534145M91)				30/153-240 (3534550M1)	30/154-248 (3534528M1)
	With A/C / Con acond. 30/150-122 (3650779M91)					
1014 (Early / Primeros modelos)	30/150-123 (3304168M92)				30/153-219 (3301097M1)	30/154-115 (3301095M1)
1014 (Late / Ultimos modelos) 1024					30/154-212 (1425333M1)	
1104				30/153-113 (1822671M1)	30/154-215 (1424534M1)	
1114, 1134	30/150-124 (3304174M92)			30/153-112 (1425332M1)	30/154-212 (1425333M1)	

Part numbers are quoted for reference purposes only.
Our parts and accessories are not original.

Las referencias originales tienen un propósito identificativo.
Nuestras piezas no son originales.



RADIATORS & HOSES RADLADORES Y MANGUITOS



	1	2	3	4	5
Tractors Tractores	Radiator Radlador	Cap Tapón	Drain tap Grifo de drenaje	Top Hose Manguito sup.	Bottom hose Manguito inf.
Industrial tractors / Palas retrocargadoras					
20B, 20E	30/150-15 (1680547M92)				30/154-5 (1860374M2)
20D		30/151-8 (1874445M93)		30/153-11 (1869514M1)	30/154-11 (1662089M1)
20F, 30E, 30H	30/150-15 (1680547M92)				30/154-250 (3505655M1)
30D	30/150-12 (1876606M4)			30/153-9 (899144M1)	30/154-9 (898748M1)
40	30/150-4 (1660499M92)	7 Lbs L.R. 30/151-2 (3475308M1) 10 Lbs L.R. 30/151-3 (3637301M1)	30/55-2 (1851095M2, 31419M)	30/153-11 (1869514M1)	30/154-4 (186968M1)
40E	30/150-15 (1680547M92)	30/151-8 (1874445M93)			30/154-250 (3505655M1)
50 (AD4.203)	30/150-9 (897358M4)	30/151-2 (3475308M1)		30/153-7 (898064M1)	30/154-7 (898065M1)
50 (A4.212 & A4.236) 50B (UK ⇨ L5373)	30/150-10 (885580M3)	30/151-3 (3637301M1)		30/153-9 (899144M1)	
50B (France ⇨ L5373)	30/150-17 (1459214M92)			30/153-37 (535203M1)	30/154-9 (898748M1)
50B (L5374 ⇨), 50BMKII, 50D	30/150-16 (3820620M91)	30/151-8 (1874445M93)		30/153-130 (1692004M1)	
50E, 50EX	30/150-17 (1459214M92)	30/151-3 (3637301M1)		30/153-37 (535203M1)	
50H, 50H-S, 50HX, 50HX-S, 60H, 60H-S					

Part numbers are quoted for reference purposes only.
Our parts and accessories are not original.

Las referencias originales tienen un propósito identificativo.
Nuestras piezas no son originales.



RADIATOR HOSES
MANGUITOS RADLADOR

30/153-1 	30/153-2 	30/153-3 	30/153-6 	30/153-7 
30/153-8 	30/153-9 	30/153-11 	30/153-37 	30/153-38 
30/153-39 	30/153-40 	30/153-41 	30/153-43 	30/153-44 
30/153-45 	30/153-64 	30/153-65 	30/153-66 	30/153-68 
30/153-111 	30/153-112 	30/153-113 	30/153-114 	30/153-130 
30/153-131 	30/153-132 	30/153-133 	30/153-134 	30/153-135 
30/153-136 	30/153-137 	30/153-138 	30/153-139 	30/153-140 
30/153-143 	30/153-218 	30/153-219 	30/153-227 	30/153-228 
30/153-229 	30/153-230 	30/153-231 	30/153-232 	30/153-233 

Part numbers are quoted for reference purposes only.
Our parts and accessories are not original.

Las referencias originales tienen un propósito identificativo.
Nuestras piezas no son originales.



RADIATOR HOSES
MANGUITOS RADLADOR







30/153-234 	30/153-235 	30/153-236 	30/153-237 	30/153-238 
30/153-239 	30/153-240 			
30/154-1 	30/154-2 	30/154-3 	30/154-4 	30/154-5 
30/154-6 	30/154-7 	30/154-8 	30/154-9 	30/154-10 
30/154-11 	30/154-38 	30/154-39 	30/154-40 	30/154-41 
30/154-43 	30/154-44 	30/154-45 	30/154-64 	30/154-66 
30/154-69 	30/154-113 	30/154-114 	30/154-115 	30/154-130 
30/154-131 	30/154-132 	30/154-133 	30/154-134 	30/154-135 
30/154-136 	30/154-137 	30/154-138 		

Part numbers are quoted for reference purposes only.
Our parts and accessories are not original.

Las referencias originales tienen un propósito identificativo.
Nuestras piezas no son originales.



RADIATOR HOSES
MANGUITOS RADLADOR

30/154-139 	30/154-208 	30/154-209 	30/154-210 	30/154-211 
30/154-212 	30/154-213 	30/154-215 	30/154-227 	30/154-228 
30/154-230 	30/154-231 	30/154-232 	30/154-233 	30/154-234 
30/154-236 	30/154-237 	30/154-238 	30/154-239 	30/154-240 
30/154-241 	30/154-242 	30/154-243 	30/154-244 	30/154-245 
30/154-246 	30/154-247 	30/154-248 		

Part numbers are quoted for reference purposes only.
Our parts and accessories are not original.

Las referencias originales tienen un propósito identificativo.
Nuestras piezas no son originales.



**EXHAUST MANIFOLDS
COLECTORES DE ESCAPE**



Tractors Tractores	Engine Motor	Fig.	Manifold Colector	Gasket Junta colector
35, 133, 135 35	A3.144 A3.152	1	30/65-1 (37781251, 731267M1)	30/66-1 (4223501M1)
133, 134, 135, 140, 145, 152, 154, 233, 234, 244CF, 253(Italy), 254, 333, 334V, 353, 354, 356CF, 2205, 3210 Outlet / Salida 180°	AD3.152	2	30/65-2 (37781341, 734874M1)	30/66-2 (4222050M1)
133, 135, 140, 148, 152, 230, 235, 240, 245, 250, 255, 340, 342, 350 Outlet / Salida 90°	AD3.152	3	30/65-3 (37781571, 740221M1)	
165, 174 168, 174, 175, 184, 273, 274, 283, 284, 367CF, 373, 374, 376C, 383, 384, 3220 178, 194, 293, 294, 393, 394, 396C, 3235 Outlet / Salida 180° 30D, 50, 50B, 50BMKII, 50D/E/EX/H/HS/HX/HXS, 60H/HS	A4.212 A4.236 A4.248	4	30/65-5 (37781333, 735826M1)	
165 168, 175, 265, 275, 275E, 362, 362N, 372N, 375E, 575 178, 188, 290, 382N, 390E, 590 Outlet / Salida 90° 16, 16Plot, 20, 487, 506	A4.212 A4.236 A4.248	5	30/65-7 (37781781, 736206M1)	30/66-3 (3640556M1)
265, 274SK, 275, 284S, 377, 387, 565, 575 285, 290, 294S, 397, 590	A4.236 A4.248	6	30/65-6 (37781051, 741764M1)	

 <p>30/66-1 4223501M1, 36833167 Engine A3.152 Motor</p>	 <p>30/66-2 4222050M1, 36862143 Engine AD3.152 Motor</p>	 <p>30/66-3 3640556M1, 36862189 Engine A4.212, A4.236, A4.248, AT4.236, 1004.4, 1004.4T Motor</p>
---	--	---



Part numbers are quoted for reference purposes only.
Our parts and accessories are not original.

Las referencias originales tienen un propósito identificativo.
Nuestras piezas no son originales.



EXHAUST ELBOW
CODOS DE ESCAPE



Tractor: Tractores	Fig.	Elbow Codo	Gasket Junta de soporte	A	B	C
TEA20, TED20, 35 (85mm Petrol)	1	30/164-1 (640010M1)	30/167-1 (825003M1)	39	67	50.7
TEF20, FE35 (Diesel)	2	30/164-2 (824245M1)		35		
35, 135 (87mm Petrol)	3	30/164-3 (899130M1)	30/167-2 (4222475M1)	33	67	50
35, 133, 135, 140, 145, 152	4	30/164-4 (898011M1)		42	66	54
65, 165, 260, 765	5	30/164-5 (897914M1)	30/167-3 (3638761M1)	45	71	54
165, 175, 178	6	30/164-6 (897913M1)		55	80	54
65, 165, 168, 175, 178, 185, 188, 265, 275, 290, 362, 372N, 565, 575, 590  30D	7	30/164-7 (1862807M1)	30/167-2 (4222475M1)	42	66	50.7
135, 148, 230, 235, 240, 245, 250, 255, 340, 342, 350, 550  20B, 20D, 20E	8	30/164-8 (1693855M1)				

Part numbers are quoted for reference purposes only.
Our parts and accessories are not original.

Las referencias originales tienen un propósito identificativo.
Nuestras piezas no son originales.



**SILENCERS
SILENCIOSOS**

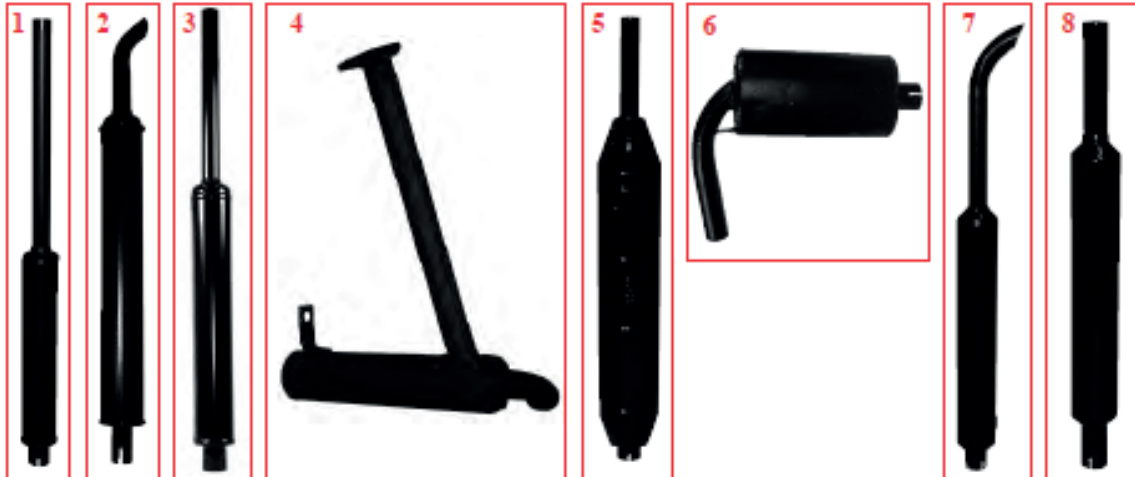

Tractors Tractores	Fig.	Ref. Ref.	OEM	A	B	C	D	E	F	G	H	Description Descripción
TE20, 35, 135, 148, 152 240 (⇒ 522353) 250, 235, 245, 530 20B, 20D, 20E	1	30/165-1	1683796M3 894291M2	38	51.5	530	470	55	75			Painted Pintado
		30/165-1S										Enamelled Esmaltado
TE20, 35, 35X, 37, 133, 135, 140, 145, 148, 235, 245, 250, 255	2	30/165-6	890476M93 180364M92	36	39	400	570	70	80			Painted Pintado
65, 134C, 154C, 155, 158, 165, 168, 174C, 175S, 178, 184, 185, 188, 194, 565, 575 20F, 30E, 30H, 40, 50 /B/BMK/L/D/E/EX/H/HS, 50HX/HXS, 60H/HS	3	30/165-2	898228M94	39	54	480	600	70	95			Painted Pintado
		30/165-2S										Enamelled Esmaltado
133, 135, 140, 145, 152	4	30/165-157	969353M1	42		127	548		82			Painted Pintado
134, 154, 164, 174, 184, 194, 233, 234, 244CF, 254, 264, 274, 294, 333, 334V, 353, 354, 363, 364, 373, 374, 376C, 377, 383, 384, 387, 393, 394, 396, 397	5	30/165-145	3530335M91	42	55	275	800	50	100 x 130			Enamelled Esmaltado
154F, 174F, 184F, 194F 354, 364, 374, 384, 394 AP/F/FP/GE/S/SP 3210, 3220, 3225, 3235	6	30/165-146	3531689M92	43	50	300	495	60	95 x 165			Painted Pintado
154 /F/S, 174 /F/S, 184 /S, 194 /C/F/S, 234 /C/CF/S, 254 /C/CF/S, 263T, 264 /T/TCF/TS, 274 /C/CF/S/SK, 284 /S, 294 /C/S	7	30/165-147	1427799M94	46	55	460	600	65	102			Painted Pintado
260, 265, 275, 285, 290, 560, 565, 575, 590 Up the bonnet fitting Montaje sobre capot	8	30/165-28	1672994M93 1894207M91	52	55	480	460	100	112			Painted Pintado
265, 275, 290, 375, 390, 362N, 372N, 382N, 565, 575, 590, 30D Side fitting / Montaje lateral	1	30/165-27	3821782M91	52	55	500	455	415	112			Painted Pintado
	7	30/165-162		52	55	500	455	415	112			Painted Pintado

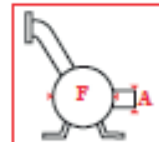
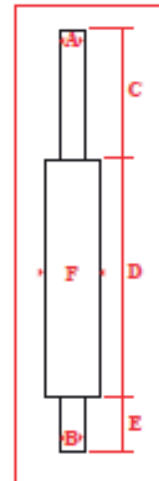

Part numbers are quoted for reference purposes only.
Our parts and accessories are not original.

Las referencias originales tienen un propósito identificativo.
Nuestras piezas no son originales.



**SILENCERS
SILENCIOSOS**

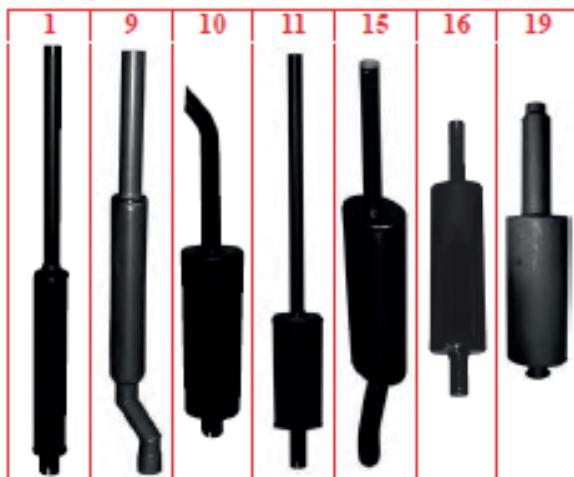

Tractors Tractores	Fig.	Ref. Ref.	OEM	A	B	C	D	E	F	G	H	Description Descripción
298, 595, 698, 1080	9	30/165-120	3600200M91	57	70	400	500	320	100 x 195			Painted Pintado
298, 699	10	30/165-155	1693294M1	55	75	490	610	75	100 x 195			Enamelled Esmaltado
340, 342, 350, 352, 355, 360, 362, 362N, 372N, 382N	11	30/165-26	3821781M91	42	51.5	820	380	150	80 x 160			Painted Pintado
365, 375 390 (B18009 ⇔)	12	30/165-110	1694961M5	55			430	150				Painted Pintado
390 (⇔ B18008) 390T, 398	13	30/165-109	1694963M5	63			402	150				Painted Pintado
396, 399	14	30/165-108	1694965M6	63			430	150				Painted Pintado
675, 690	1	30/165-29	1680877M92	51.5	55	710	455	175	112			Painted Pintado
698	15	30/165-156	1680529M92	55	72	460	610	310				Painted Pintado
1014, 1024	16	30/165-70	3301158M94	68	70	490	540	70	130 x 210			Painted Pintado
1114	17	30/165-111	1427504M95	73	70	120	570	230	120 x 230			Enamelled Esmaltado
1134	18	30/165-112	1427506M96	88	85	50	710	60	120 x 230			Enamelled Esmaltado
2620, 2625, 2640, 2645	19	30/165-148	3041515M94	73	76	405	545	70	150 x 225			Painted Pintado
3065	20	30/165-121	3582118M1							47	89	Painted Pintado
3015, 3060, 3080, 6110, 6120	21	30/165-122	3388434M1							59	80	Painted Pintado
3080, 3085, 3095, 6160, 6170	22	30/165-123	3388432M2							66	89	Painted Pintado

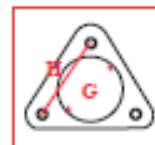
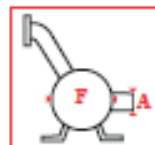
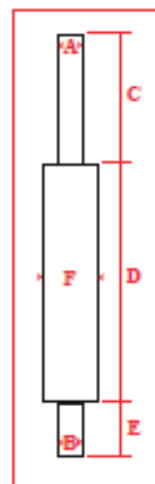

Part numbers are quoted for reference purposes only.
Our parts and accessories are not original.

Las referencias originales tienen un propósito identificativo.
Nuestras piezas no son originales.



EXTENSION PIPES FOR SILENCERS
TUBOS DE EXTENSIÓN PARA SILENCIOS



Tractors <i>Tractores</i>	Ref. <i>Ref.</i>	OEM
365, 375, 390	30/166-16 Lg 1000mm	1696602M3
	30/166-18 Lg 1100mm	3598406M6
390, 390T, 396, 398, 399	30/166-17	1696603M3
3050, 3060, 3065, 3070, 3075, 3080, 3085, 3090, 3095, 3115, 3120, 4215, 4220, 4225, 4235, 4240, 4245, 4255, 4260, 4265, 4270, 4315, 4320, 4325, 4335, 4345, 4355, 4360, 4365, 4370, 6110, 6120, 6130, 6140, 6150, 6160, 6170, 6180, 6235, 6245, 6255, 6260	30/166-15	3383014M7
4225, 4235, 4240, 4245, 4255, 4260, 4265, 4270, 4325, 4335, 4365	30/166-14	3819457M1
6160, 6170, 6180, 6190, 8110, 8120, 8130, 8140, 8150, 8160, 8170, 8180	30/166-13	3714356M4

WEATHER CAPS
TAPAS DE ESCAPE



Ref. <i>Ref.</i>	OEM	Pipe max Ø <i>Máx tubo Ø</i>
70/2930-35		35mm-1 ^{3/8} "
70/2930-38		38mm-1 ^{1/2} "
70/2930-45		45mm-1 ^{3/4} "
70/2930-51	190915M91	51mm-2"
70/2930-57	001686U91	57mm-2 ^{1/4} "
70/2930-64		64mm-2 ^{1/2} "
70/2930-70		70mm-2 ^{3/4} "
70/2930-76	1092639V1, 273738M91	76mm-3"
70/2930-89	1498008V1	89mm-3 ^{1/2} "
70/2930-95		95mm-3 ^{3/4} "
70/2930-102	1022537M91	102mm-4"
70/2930-108		108mm-4 ^{1/4} "
70/2930-114		114mm-4 ^{1/2} "
70/2930-127		127mm-5"
70/2930-152		152mm-6"

EXHAUST CLAMPS
ABRAZADERAS



Ref. <i>Ref.</i>	OEM	Pipe max Ø <i>Máx tubo Ø</i>
70/2935-45		45mm-1 ^{3/4} "
70/2935-48		48mm-1 ^{7/8} "
70/2935-51		51mm-2"
70/2935-54	1674071M92	54mm-2 ^{1/8} "
70/2935-58	1676470M91, 3599710M91	58mm-2 ^{1/4} "
70/2935-70	1696972M91, 2700058M91, 3384824M1	70mm-2 ^{3/4} "
70/2935-79		79mm-3 ^{1/8} "
70/2935-92		92mm-3 ^{5/8} "

Part numbers are quoted for reference purposes only.
Our parts and accessories are not original.

Las referencias originales tienen un propósito identificativo.
Nuestras piezas no son originales.



FILTERS FILTROS



3



2



- ⊙ CAV 7111/296
- ⊕ Repl./Reem. CAV 296
- CAV 796
- ⊕ Repl./Reem. CAV 796
- ⤵ Spin on / Rosca
- Cartridge / Cartucho

- H Power steering
Dirección asistida
- ⌚ Auxiliary circuit
Circuito auxiliar
- ⊗ Oil cooler
Refrigerador de aceite
- ⚙ Internal hydr. pump
Bomba hidráulica interna
- ⚙ External circuit
Circuito externo

Tractors Tractores	Engine Motor	1		2	3	4	
		Air / aire				Oil Aceite	Fuel Combustible
		Out. / Ext.	Imm. / Int.			Lift / Elev.	
French, UK & USA tractors / Tractores franceses, ingleses y americanos							
TEA20, 35 (Petrol)	85mm Petrol 87mm Petrol			60/96-3 (26560090, 1896000M91)			
TEF20, FE35 FE35, 835 (Diesel / Diesel)	20C 23C			60/96-1 (26540218, 894976M91)	60/111-1 (32327, 1850450M2) + 60/111-2 (31944, 1884736M91)		
25, 122 25, 825	A4.99 A4.107				60/111-2 (31944, 1884736M91)		
30, 130	A4.107				60/111-5 ⊙ (26560017, 836218M91) = 60/111-3 ⊕ (26561117, 3405418M1)		
35, 140	A3.144 A3.152			60/96-2 (26540132, 1883258M91)	60/111-1 (32327, 1850450M2) or / o 60/111-5 ⊙ (26560017, 836218M91) = 60/111-3 ⊕ (26561117, 3405418M1)	60/625-1 (521451M1)	
65	A4.192				60/111-1 (32327, 1850450M2) + 60/111-2 (31944, 1884736M91)		
65, 765	AD4.203				60/111-1 (32327, 1850450M2) + 60/111-5 ⊙ (26560017, 836218M91) = 60/111-3 ⊕ (26561117, 3405418M1)	60/625-1 (521451M1)	60/574-3 H (1883318M1) Ht. / Al. 62mm Ø 85mm

Part numbers are quoted for reference purposes only.
Our parts and accessories are not original.

Las referencias originales tienen un propósito identificativo.
Nuestras piezas no son originales.



FILTERS FILTROS							
⊕ CAV7111/296 ⇔ Repl. / Reempl. CAV296 ● CAV796 ⚡ Repl. / Reempl. CAV796 ⚡ Spin on / Roscado □ Cartridge / Cartucho ⊞ Power steering / Dirección asistida ⊕ Auxiliary circuit / Circuito auxiliar ⊕ Oil cooler / Refrigerador de aceite ⚡ Internal hydr. pump / Bomba hidráulica interna ⚡ External circuit / Circuito externo							
Tractors Tractores	Engine Motor	1		2	3	4	
		Air / Aire		Oil Aceite	Fuel Combustible	Hydraulic / Hidráulico	
		Out. / Ext.	Inn. / Int.			Lift / Elev.	
French, UK & USA tractors / Tractores franceses, ingleses y americanos							
133, 135, 140 (Etroit / Narrow)	A3.144	60/161-100 (1805045M2) <i>Lautrette</i> 60/161-63 (1807255M1)		60/96-2 □ (26540132, 1883258M91) 60/97-1 ⚡ (2654408, 1447082M91)		60/655-3 (1810539M91) 60/625-2 (1687042M91)	
133, 135MKIII, 135V	AD3.152			60/97-1 ⚡ (2654408, 1447082M91)		60/625-2 (1687042M91)	
135	AD3.152	60/161-1 (26510232, 1886637M91) Ht. / Al. 235mm or / o 60/161-100 (1805045M2) Ht. / Al. 275mm	60/162-1 (26510233, 1886638M91)	60/96-3 □ (26560090, 1896000M91) 60/97-1 ⚡ (2654408, 1447082M91)		60/655-3 (1810539M91)	60/655-1 ● (191855M4)
135, 140, 145 export	AD3.152	60/161-100 (1805045M2) <i>Lautrette</i> 60/161-63 (1807255M1) <i>Fins / Aletas</i>		60/96-2 □ (26540132, 1883258M91) 60/97-1 ⚡ (2654408, 1447082M91)	60/111-5 ⊕ (26560017, 836218M91) = 60/111-3 ⊕ (26561117, 3405418M1)	60/655-2 ● (1862918M91) Ht. / Al. 79 mm or / o 60/655-1 ● (191855M4) <i>Lift / Levante</i> 60/625-2 (1687042M91) ⊕ 60 mm Ht. / Al. 96 mm or / o 60/625-1 (521451M1) ⊕ 63 mm Ht. / Al. 99 mm	60/574-1 ⊞ (1886135M1) Ht. / Al. 40mm ⊕ 50mm
135, 138, 145V/S, 145MKIII, 148MKIII	AD3.152	60/161-100 (1805045M2) <i>Lautrette</i>		60/96-3 □ (26560090, 1896000M91) 60/97-1 ⚡ (2654408, 1447082M91)		60/625-2 (1687042M91) ⊕ 60 mm Ht. / Al. 96 mm	60/574-1 ⊞ (1886135M1) Ht. / Al. 40mm ⊕ 50mm
148	AD3.152	60/161-1 (26510232, 1886637M91) Ht. / Al. 235mm or / o 60/161-100 (1805045M2) Ht. / Al. 275mm	60/162-1 (26510233, 1886638M91)	60/96-2 □ (26540132, 1883258M91)		60/625-2 (1687042M91) ⊕ 60 mm Ht. / Al. 96 mm	
152, 152F/V/S, 152MKIII	AD3.152	60/161-100 (1805045M2)		60/97-1 ⚡ (2654408, 1447082M91)		60/625-2 (1687042M91) ⊕ 60 mm Ht. / Al. 96 mm	60/655-3 ● (1810539M91) 60/655-4 (1810694M92) <i>Aspir. / Aspir.</i>

Part numbers are quoted for reference purposes only.
Our parts and accessories are not original.

Las referencias originales tienen un propósito identificativo.
Nuestras piezas no son originales.



**FILTERS
FILTROS**

⊗ CAV7111/296 ⊕ Repl. / Reem.CAV296 ● CAV796 ⚡ Repl. / Reem.CAV796 ⚡ Spin on / Rascado □ Cartridge / Cartucho ▢ Power steering / Dirección asistida
⊕ Auxiliary circuit / Circuito auxiliar ⊗ Oil cooler / Refrigerador de aceite ⚡ Internal hydr. pump / Bomba hidráulica interna ⚡ External circuit / Circuito externo

Tractors Tractores	Engine Motor	1		2	3	4	
		Air / Aire		Oil	Fuel	Hydraulic / Hidráulico	
		Out. / Ext.	Int. / Int.	Acéite	Combustible	Lift / Elev.	
French, UK & USA tractors / Tractores franceses, ingleses y americanos							
155, 158, 158MKIII, 158 F/S/V	AD4.203			60/96-2 □ (26540132, 1883258M91)		60/625-2 (1687042M91) Ø 60 mm Ht./Al 96 mm	
		60/161-3 (26510236, 880271M1)	60/162-3 (26510237, 1887575M91)	60/97-1 ⚡ (2654408, 1447082M91) or / o 60/97-43 ⚡ (3638606M1) 13/16"		60/655-3 ● (1810539M91)	
				60/97-43 ⚡ (3638606M1) 13/16"		60/655-4 (1810694M92) Aspir. / Aspir.	
165 165, 165MKII, 865 168, 175, 175S 178, 185, 188	A4.212 AD4.203 A4.236 A4.248			60/96-3 □ (26560090, 1896000M91)		60/655-2 ● (1862918M91) Ht./Al 79 mm or / o 60/655-1 ● (191855M4) Ht./Al 115 mm or / o 60/655-3 ● (1810539M91) Ht./Al 155mm	60/574-21 H (1645894M91) Ht./Al 56 - Ø84 or / o 60/574-3 H (1883318M1) Ht./Al 62 - Ø85 or / o 60/574-4 H (1662566M1) Ht./Al 74 - Ø71
		60/161-3 (26510236, 880271M1)	60/162-3 (26510237, 1887575M91)	60/97-2 ⚡ (2654403, 1447048M1)		60/625-2 (1687042M91)	
230	AD3.152	60/161-12 (1688092M2)	60/162-12 (3824033M1)		60/111-5 ⊗ (26560017, 836218M91) = 60/111-3 ⊕ (26561117, 3405418M1)	60/625-14 (3771122M92)	60/574-2 H (1052097M1)
235, 245, 255	AD3.152	60/161-98 (1698675M2)	60/162-98 (1698676M1)			60/625-2 (1687042M91)	60/574-1 H (1886135M1)
240	AD3.152			60/97-1 ⚡ (2654408, 1447082M91)		60/625-14 (3771122M92) or / o 60/625-2 (1687042M91)	60/574-1 H (1886135M1) Ht./Al 40 - Ø50 or / o 60/574-2 H (1052097M1) Ht./Al 38 - Ø52
						60/655-4 (1810694M92)	
250	AD3.152	60/161-12 (1688092M2)	60/162-12 (3824033M1)	(F) 60/97-2 ⚡ (2654403, 1447048M1) (UK) 60/97-1 ⚡ (2654408, 1447082M91)		60/655-3 (1810539M91) Ht./Al 155mm or / o 60/655-4 (1810694M92) Ht./Al 160mm	
						60/625-2 (1687042M91)	

Part numbers are quoted for reference purposes only.
Our parts and accessories are not original.

Las referencias originales tienen un propósito identificativo.
Nuestras piezas no son originales.



FILTERS FILTROS							
⊕ CAV7111296 ⇔ Repl. / Reem.CAV296 ● CAV796 ⚡ Repl. / Reem.CAV796 ⚡ Spin on / Roscado Ⓜ Cartridge / Cartucho Ⓜ Power steering / Dirección asistida ⊕ Auxiliary circuit / Circuito auxiliar ⊕ Oil cooler / Refrigerador de aceite ⚡ Internal hydr. pump / Bomba hidráulica interna ⚡ External circuit / Circuito externo							
Tractors Tractores	Engine Motor	1		2	3	4	
		Air / Aire		Oil Aceite	Fuel Combustible	Hydraulic / Hidráulico	
		Out. / Ext.	Inn. / Int.			Lift / Elev.	
French, UK & USA tractors / Tractores franceses, ingleses y americanos							
253 263	AT3.152.4 903.27T	60/161-22 (3395518M1)	60/162-22 (3395519M1)	60/97-1 ⚡ (2654408, 1447082M91)	60/111-5 ⊕ (26560017, 836218M91) = 60/111-3 ⇔ (26561117, 3405418M1)	60/625-14 (3771122M92) 60/655-4 ⊕ (1810694M92)	60/574-1 H (1886135M1)
260	AD4.203	60/161-99 (1698683M1)	60/162-99 (1698684M1)		60/111-3 ⇔ (26561117, 3405418M1)	60/655-4 ⊕ (1810694M92) Aspir. / Aspire	
265 (F) 265 (UK) (⇔193552) 275 (⇔221522)	A4.236	60/161-13 (1678294M1)	60/162-13 (1678295M1)		60/111-5 ⊕ (26560017, 836218M91) = 60/111-3 ⇔ (26561117, 3405418M1) or / o 60/111-6 ● (26560602, 1896287M91) = 60/111-4 ⚡ (26566602, 3405419M1)	60/655-3 ● (1810539M91) 60/655-4 (1810694M92) Aspir. / Aspire 60/625-2 (1687042M91) or / o 60/625-14 (3771122M92)	60/574-4 H (1662566M1)
265 (UK) (193553 ⇔) 275 (221523 ⇔) 275E 265S, 285S 275E	A4.236 A4.41	60/161-78 (3824035M1)	60/162-78 (3824036M1)	60/97-2 ⚡ (2654403, 1447048M1)	60/111-6 ● (26560602, 1896287M91) = 60/111-4 ⚡ (26566602, 3405419M1)	60/655-3 (1810539M91) 60/655-4 (1810694M92) Aspir. / Aspire 60/625-14 (3771122M92)	
290 (F) 290 (UK) (⇔387020) 290E	A4.248 A4.41	60/161-13 (1678294M1)	60/162-13 (1678295M1)		60/111-6 ● (26560602, 1896287M91) = 60/111-4 ⚡ (26566602, 3405419M1)	60/655-3 (1810539M91) 60/655-4 (1810694M92) Aspir. / Aspire 60/625-14 (3771122M92)	
290 (UK) (387021⇔) 290E	A4.248	60/161-78 (3824035M1)	60/162-78 (3824036M1)		60/111-4 ⚡ (26566602, 3405419M1)	60/625-14 (3771122M92)	
298	A4.318.2	60/161-14 (1698374M2)	60/162-14 (1698375M2)		60/111-5 ⊕ (26560017, 836218M91) = 60/111-3 ⇔ (26561117, 3405418M1)	60/625-2 (1687042M91) 60/240-25 (3307250M91) 60/655-4 (1810694M92)	
340, 342, 350	AD3.352			60/97-1 ⚡ (2654408, 1447082M91)	60/111-3 ⇔ (26561117, 3405418M1)	60/625-2 ● (1687042M91) or / o 60/625-14 ● (3771122M92) 60/625-4 ● (3800305M91)	60/574-1 H (1886135M1)
352, 355, 360	AT3.152	60/161-22 (3395518M1)	60/162-22 (3395519M1)			60/625-14 ● (3771122M92) 60/625-4 ● (3800305M91)	60/569-1 H⚡ (3395175M1)
362, 362N, 372, 372N, 382, 382N	A4.236 A4.248					60/625-4 ● (3800305M91)	60/569-1 H⚡ (3395175M1)
365, 375 390 390T, 398 396, 399 399	A4.236 A4.248 AT4.236 1006.6 A6.354.4	60/161-23 (3395500M1) Over bonnet Sobre capot ⊙ 177mm 60/161-24 (3395503M1) Under bonnet Bajo capot ⊙ 155mm	60/162-23 (3395501M1)	60/97-2 ⚡ (2654403, 1447048M1)	60/111-6 ● (26560602, 1896287M91) = 60/111-4 ⚡ (26566602, 3405419M1)	60/625-2 ● (1687042M91) or / o 60/625-14 ● (3771122M92) 60/625-4 ● (3800305M91)	60/574-1 H (1886135M1) 60/569-1 H⚡ (3395175M1)

Part numbers are quoted for reference purposes only.
Our parts and accessories are not original.

Las referencias originales tienen un propósito identificativo.
Nuestras piezas no son originales.



FILTERS FILTROS							
☉ CAV7111/296 ☉ Repl. / Reem.CAV296 ● CAV796 ☉ Repl. / Reem.CAV796 ☉ Spin on / Roscado ☐ Cartridge / Cartucho ☐ Power steering / Dirección asistida ☉ Auxiliary circuit / Circuito auxiliar ☉ Oil cooler / Refrigerador de aceite ☉ Internal hydr. pump / Bomba hidráulica interna ☉ External circuit / Circuito externo							
Tractors Tractores	Engine Motor	1		2	3	4	
		Air / Aire		Oil Aceite	Fuel Combustible	Hydraulic / Hidráulico	
		Out. / Ext.	Inn. / Int.			Lift / Elev.	
French, UK & USA tractors / Tractores franceses, ingleses y americanos							
375E 390E	A4.236 A4.248	60/161-78 (3824033M1)	60/162-78 (3824036M1)	60/97-2 ☉ (2654403, 1447048M1)		60/625-2 ● (1687042M91)	60/574-1 H (1886133M1)
375E, 390E	A4.41					60/625-4 ● (3800303M91)	60/569-1 H ☉ (3595175M1)
550	AD3.152	☉ 619578 60/161-98 (1698675M2) 619579 ☉ 60/161-12 (1688092M2)	60/162-98 (1698676M1) 60/162-12 (3824033M1)	60/97-1 ☉ (2654408, 1447082M91)	60/111-6 ● (26560602, 1896287M91) = 60/111-4 ☉ (26566602, 3405419M1)	60/655-3 ● (1810539M91) or / o 60/655-4 ● (1810694M92)	60/574-1 H (1886133M1) Ht. / Al. 40 - Ø50 or / o 60/574-2 H (1032097M1) Ht. / Al. 38 - Ø52
560	AD4.203	60/161-99 (1698683M1)	60/162-99 (1698684M1)				60/574-4 H (1662566M1)
565	A4.236						
575	A4.236	60/161-13 (1678294M1)	60/162-13 (1678295M1)				
590	A4.248						
592, 595	A4.318					60/625-2 ● (1687042M91)	60/574-21 H (1645894M91) Ht. / Al. 56 - Ø84 or / o 60/574-4 H (1662566M1) Ht. / Al. 74 - Ø71
		60/161-14 (1698374M2)	60/162-14 (1698375M2)	60/97-2 ☉ (2654403, 1447048M1)	60/111-5 ☉ (26560017, 836218M91) = 60/111-3 ☉ (26561117, 3405418M1)		
675	A4.236	60/161-13 (1678294M1)	60/162-13 (1678295M1)				
690	A4.248						
698	A4.318.2	60/161-14 (1698374M2)	60/162-14 (1698375M2)			60/625-2 ● (1687042M91)	60/574-4 H (1662566M1)
698T	AT4.236					60/655-4 ● (1810694M92)	
699	A6.354.4	60/161-25 (1062501M91)	60/162-25 (26510228, 1093683M92)	60/97-3 ☉ (2654407, 1447031M1)			
1004	A4.318.2	60/161-14 (1698374M2)	60/162-14 (1698375M2)				
1004T	AT4.236	60/161-25 (1062501M91)	60/162-25 (26510228, 1093683M92)	60/97-2 ☉ (2654403, 1447048M1)		60/655-4 (1810694M92)	60/574-4 H (1662566M1)
1080	A4.318	60/161-95 (1035408M92) Less flange Sin pestaña		60/96-3 ☐ (26560090, 1896000M91) or / o 60/97-2 ☉ (2654403, 1447048M1)	60/111-5 ☉ (26560017, 836218M91) = 60/111-3 ☉ (26561117, 3405418M1)	60/240-7 ● 60/655-1 ● (191855M4) (☉ M273000) 60/655-3 ● (1810539M91) (M273001 ☉)	60/574-21 H (1645894M91)
1200 1250	A6.354.1 A6.354.4	60/161-60 (3638563M1)	60/162-25 (26510228, 1093683M92)			60/625-2 ● (1687042M91) 60/574-14 ● (1039161M91)	60/655-3 (1810539M91)
2620, 2640 (271213 ☉) 2680	A6.354.4 A6.354.4 AT6.354.4	60/161-25 (1062501M91)	60/162-25 (26510228, 1093683M92)	60/97-3 ☉ (2654407, 1447031M1)		60/240-28 ☐ (1636924M3) or / o 60/240-61 ☉ (3383386M92)	
2640 (☉ 271212)	A6.354.4	60/161-97 (1633459M1)	60/162-97 (1633458M1)				

Part numbers are quoted for reference purposes only.
Our parts and accessories are not original.

Las referencias originales tienen un propósito identificativo.
Nuestras piezas no son originales.



FILTERS FILTROS							
⊕ CAV7111/296 ⊖ Repl. / Reem.CAV296 ● CAV796 ⊕ Repl. / Reem.CAV796 ⤴ Spin on / Roscado □ Cartridge / Cartucho ⚡ Power steering / Dirección asistida ⊕ Auxiliary circuit / Circuito auxiliar ⊕ Oil cooler / Refrigerador de aceite ⚡ Internal hydr. pump / Bomba hidráulica interna ⚡ External circuit / Circuito externo							
Tractors Tractores	Engine Motor	1 Air / Aire		2 Oil Aceite	3 Fuel Combustible	4 Hydraulic / Hidráulico	
		Out. / Ext.	Int. / Int.			Lift / Elev.	
French, UK & USA tractors / Tractores franceses, ingleses y americanos							
2625, 2645 2685	A6.354.4 AT6.354.4			60/97-3 ⤴ (2654407, 1447031M1)	60/111-6 ● (26560602, 1896287M91) = 60/111-4 ⊕ (26566602, 3405419M1)	60/240-28 □ (1636924M3) or / o	
2720	AT6.354.4	60/161-26 (1644333M1)	60/162-26 (1644334M1)		60/111-5 ⊕ (26560017, 836218M91) = 60/111-3 ⊖ (26561117, 3405418M1)	60/240-61 ⤴ (3383386M92)	
2725	AT6.354.4			60/97-2 ⤴ (2654403, 1447048M1)	60/111-6 ● (26560602, 1896287M91) = 60/111-4 ⊕ (26566602, 3405419M1)	60/240-61 ⤴ (3383386M92)	
3050 3060 3065	A4.236 A4.248 AT4.236	60/161-25 (1062501M91) 60/161-104 (3310355M91) <i>Steep nose Capot inclinado</i>	60/162-25 (26510228, 1093683M92)		60/111-5 ⊕ (26560017, 836218M91) = 60/111-3 ⊖ (26561117, 3405418M1)	60/240-41 H (3619594M1) 6" or / o 60/574-7 H (3615949M2) 8"	
3070	AT4.236						
3080, 3090	A6.354	60/161-25 (1062501M91)	60/162-25 (26510228, 1093683M92)	60/97-3 ⤴ (2654407, 1447031M1)	60/111-5 ⊕ (26560017, 836218M91) = 60/111-3 ⊖ (26561117, 3405418M1)	60/625-6 (3616579M2) Fit. / Alt. 98mm	
3075	1004.4T			60/97-2 ⤴ (2654403, 1447048M1)	60/111-63 (3638291M1) = 60/111-25 Repl. / Reem. CAV 496	60/625-5 (3581032M2) Fit. / Alt. 165mm	
3085, 3095, 3115 3120	1006.6 1006.6T			60/97-3 ⤴ (2654407, 1447031M1)			
3125	1006.6T	60/161-27 (3385733M1)	60/162-27 (3385734M1)	60/97-2 ⤴ (2654403, 1447048M1) or / o 60/97-3 ⤴ (2654407, 1447031M1)	⊖ 514769 60/111-5 ⊕ (26560017, 836218M91) = 60/111-3 ⊖ (26561117, 3405418M1) 514770 ⊖ 60/111-63 (3638291M1) = 60/111-25 Re. / Re. CAV 496	60/240-41 H (3619594M1) 6" or / o 60/574-7 H (3615949M2) 8"	
3610	A6.354.4			60/97-3 ⤴ (2654407, 1447031M1)	60/111-5 ⊕ (26560017, 836218M91) = 60/111-3 ⊖ (26561117, 3405418M1)	60/625-7 (3386701M2)	

Part numbers are quoted for reference purposes only.
Our parts and accessories are not original.

Las referencias originales tienen un propósito identificativo.
Nuestras piezas no son originales.



FILTERS FILTROS							
☉ CAV7111/296 ☉ Repl. / Reem.CAV296 ● CAV796 ☉ Repl. / Reem.CAV796 ☉ Spin on / Roscado ☐ Cartridge / Cartucho ☒ Power steering / Dirección asistida ☌ Auxiliary circuit / Circuito auxiliar ☉ Oil cooler / Refrigerador de aceite ● Internal hydr. pump / Bomba hidráulica interna ● External circuit / Circuito externo							
Tractors Tractores	Engine Motor	Air / Aire		Oil Aceite	Fuel Combustible	Hydraulic / Hidráulico	
		Out. / Ext.	Imm. / Int.			Lift / Elev.	
French, UK & USA tractors / Tractores franceses, ingleses y americanos							
3630	AT6.354.4			60/97-2 ☉ (2654403, 1447048M1)	60/111-6 ● (26560602, 1896287M91) = 60/111-4 ☉ (26566602, 3405419M1)	60/625-7 (3386701M2)	
3635	1006.6T	60/161-27 (3385733M1)	60/162-27 (3385734M1)	60/97-2 ☉ (2654403, 1447048M1) or / o 60/97-3 ☉ (2654407, 1447031M1)	60/111-63 (3638291M1)	60/625-7 (3386701M2) RH / Derecha. 60/625-9 (3619712M1) LH / Izda.	Load sensing 60/240-40 (3618662M1)
3645	1006.6T						
3650	AT6.354.4			60/97-2 ☉ (2654403, 1447048M1)	60/111-6 ● (26560602, 1896287M91) = 60/111-4 ☉ (26566602, 3405419M1)	60/625-7 (3386701M2)	
3655	1006.6T				60/111-63 (3638291M1)	60/625-7 (3386701M2) RH / Derecha.	Load sensing 60/240-40 (3618662M1)
3670	620DS			60/97-33 (V836662111)		60/625-9 (3619712M1) LH / Izda.	
3680	612DS	60/161-77 (3580723M1)	60/162-77 (3580724M1)	60/97-34 (3637632M1)	60/111-6 ● (26560602, 1896287M91) = 60/111-4 ☉ (26566602, 3405419M1)	60/625-7 (3386701M2)	
3690	612DS			60/97-33 (V836662111) Ht. / Al. 146mm or / o 60/97-34 (3637632M1) Ht. / Al. 270mm		60/625-7 (3386701M2) RH / Derecha. 60/625-9 (3619712M1) LH / Izda.	Load sensing 60/240-40 (3618662M1)
4215, 4315 4220, 4320	903.27 903.27T	60/161-118 (3901462M1) Ht. / Al. 319mm or / o 60/161-119 (3901464M1) Ht. / Al. 359mm	60/162-118 (3901463M1) Ht. / Al. 305mm 60/162-119 (3901465M1) Ht. / Al. 345mm	60/97-2 ☉ (2654403, 1447048M1)			
4225, 4235, 4240 4225 4235	A4.41 1004.40 1004.40T	60/161-119 (3901464M1) Ht. / Al. 359mm or / o	60/162-119 (3901465M1) Ht. / Al. 345mm	60/97-2 ☉ (2654403, 1447048M1) or / o 60/97-3 ☉ (2654407, 1447031M1)	60/111-5 ☉ (26560017, 836218M91) = 60/111-3 ☉ (26561117, 3405418M1)	60/625-4 ● (3800305M91) 60/625-14 (3771122M92)	60/569-1 (3595175M1) Loss max. pump Sin bomba asnc.
4245, 4255 4265, 4365 4245, 4255, 4345, 4355 4325 4335	1004.4T 1004.4TW 1004.40T 1004.40 1004.42	60/161-120 (3901475M1) Ht. / Al. 347mm	60/162-120 (3901476M1) Ht. / Al. 360mm	60/97-3 ☉ (2654407, 1447031M1)			

Part numbers are quoted for reference purposes only.
Our parts and accessories are not original.

Las referencias originales tienen un propósito identificativo.
Nuestras piezas no son originales.



FILTERS FILTROS							
⊕ CAV7111/296 ⊖ Repl. / Reem. CAV296 ⊕ CAV796 ⊖ Repl. / Reem. CAV796 ⊕ Spin on / Roscado ⊖ Cartridge / Cartucho ⊕ Power steering / Dirección asistida ⊕ Auxiliary circuit / Circuito auxiliar ⊕ Oil cooler / Refrigerador de aceite ⊕ Internal hydr. pump / Bomba hidráulica interna ⊕ External circuit / Circuito externo							
Tractor: Tractores	Engine Motor	1		2	3	4	
		Air / Aire		Oil Aceite	Fuel Combustible	Hydraulic / Hidráulico	
		Out. / Ext.	Inn. / Int.			Lift / Elev.	
French, UK & USA tractors / Tractores franceses, ingleses y americanos							
4260, 4270	1006.6	60/161-120 (3901475M1)	60/162-120 (3901476M1)		60/111-5 ⊕ (26560017, 836218M91) =	60/625-4 ⊕ (3800305M1)	60/569-1 (3595175M1)
4260, 4360	1006.60	Ht. / Al 347mm or / o	Ht. / Al 360mm	60/97-3 ⊕ (2654407, 1447031M1)			Less aux. pump Sin bomba aux.
4270, 4370	1006.60T	60/161-121 (3901477M1)	60/162-121 (3901478M1)		60/111-3 ⊖ (26561117, 3405418M1)	60/625-14 (3771122M92)	
6110, 6120	A4.41	60/161-25 (1062501M91)		60/97-2 ⊕ (2654403, 1447048M1)			60/240-41 H (3619594M1)
6130, 6140	1004.4T	60/161-104 (3310355M91) Steep nose Capot inclinado	60/162-25 (26510228, 1093683M92)		60/111-63 (3638291M1) = 60/111-25 Repl. / Reem. CAV 496		or / o 60/574-7 H (3615949M2) 8" Load sensing 60/240-40 (3618662M1) RH / Drcha.
6150 6160, 6170 6170, 6180 6180	1004.4T 1006.6 1006.60T 1006.6T	60/161-25 (1062501M91)					60/240-85 (3714453M1) LH / Izda.
6190	1006.6T	60/161-27 (3385733M1)	60/162-27 (3385734M1)				
6235, 6245	1004.40T	60/161-119 (3901464M1)	60/162-119 (3901465M1)	60/97-3 ⊕ (2654407, 1447031M1)	60/111-5 ⊕ (26560017, 836218M91) = 60/111-3 ⊖ (26561117, 3405418M1)	60/625-6 ⊕ (3616579M2)	60/574-7 H (3615949M2)
6255	1004.40T	60/161-119 (3901464M1) Ht 359mm Steep nose Capot inclinado or / o 60/161-120 (3901475M1) Ht. / Al 347mm	60/162-119 (3901465M1) Ht. / Al 345mm 60/162-120 (3901476M1) Ht. / Al 360mm		Strainer Decantador 60/111-202 (3780299M1) 150µ		Load sensing 60/240-40 (3618662M1) RH / Drcha. 60/240-85 (3714453M1) LH / Izda.
6260 6265	1006.60 1004.40TW	60/161-120 (3901475M1)	60/162-120 (3901476M1)				Clutch Embrague 60/641-27 (3792287M1)
6270, 6280, 6290	1006.60T	60/161-121 (3901477M1)	60/162-121 (3901478M1)				
8110, 8120 8120	1006.6T 1006.60T				60/111-63 (3638291M1) = 60/111-25 Repl. / Reem. CAV 496	60/625-7 (3386701M2) RH / Drcha.	Load sensing 60/240-40 (3618662M1)
8130	1006.6T	60/161-27 (3385733M1)	60/162-27 (3385734M1)	60/97-2 ⊕ (2654403, 1447048M1)		60/625-9 ⊕ (3619712M1) LH / Izda.	
8140, 8150 8160	620DS 634DS	60/161-77 (3580723M1)	60/162-77 (3580724M1)	60/97-33 (V836662111)			
8170, 8180	645DSBIE				60/111-6 ⊕ (26560602, 1896287M91) = 60/111-4 ⊖ (26566602, 3405419M1)	RH / Drcha. 60/240-40 (3618662M1) LH / Izda. 60/240-85 (3714453M1) Ht. / Al 98 - 45cc or / o 60/240-39 (3790002M1) Ht. / Al 139 - 60cc	Full Power 60/240-40 (3618662M1)
Part numbers are quoted for reference purposes only. Our parts and accessories are not original.		Las referencias originales tienen un propósito identificativo. Nuestras piezas no son originales.					



FILTERS FILTROS

⊕ CAV7111/296 ⊖ Repl. / Reem.CAV296 ● CAV796 † Repl. / Reem.CAV796 ⚡ Spin on / Roscaada □ Cartridge / Cartucho ≡ Power steering / Dirección asistida
⊕ Auxiliary circuit / Circuito auxiliar ⊕ Oil cooler / Refrigerador de aceite ⚡ Internal hydr. pump / Bomba hidráulica interna ⚡ External circuit / Circuito externo

Tractors Tractores	Engine Motor	1		2	3	4	
		Air / Aire		Oil Aceite	Fuel Combustible	Hydraulic / Hidráulico	
		Out. / Ext.	Int. / Int.			Lift / Elev.	
French, UK & USA tractors / Tractores franceses, ingleses y americanos							
8210, 8220	1006.60T				60/111-5 ⊕ (26560017, 836218M91) = 60/111-3 ⊖ (26561117, 3405418M1) Strainer Decantador 60/111-202 (3780299M1) 150µ		Full Power 60/240-40 (3618662M1) Clutch Embrague 60/641-27 (3792287M1)
8240 8250, 8260	620DSRAE 634DSBAE	60/161-124 (3782386M1)	60/162-124 (3782387M1)		60/111-6 ● (26560602, 1896287M91) = 60/111-4 † (26566602, 3405419M1)		LH / Izda. 60/240-85 (3714453M1) Ht. / Alt 98 - 45cc or / o 60/240-39 (3790002M1) Ht. / Alt 139 - 60cc
8240Xtra 8250Xtra	620DWBAE 634DWBAE	60/161-165 (3902783M1)	60/162-165 (3902782M1)	60/97-33 (V836662111)			
8260 LST	634DSBIE	60/161-127 (5016603M1)	60/162-127 (5016604M1)				
8260Xtra	634DWBAE	60/161-126 (4270017M1)	60/162-126 (4270018M1)		Strainer Decantador 60/111-202 (3780299M1) 150µ		Full Power 60/240-40 (3618662M1)
8270, 8280	645DSBIE	60/161-127 (5016603M1)	60/162-127 (5016604M1)	60/97-61 (V836659108)			
8270Xtra, 8280Xtra	645DSBAE	60/161-126 (4270017M1)	60/162-126 (4270018M1)				

Part numbers are quoted for reference purposes only.
Our parts and accessories are not original.

Las referencias originales tienen un propósito identificativo.
Nuestras piezas no son originales.



**FILTERS
FILTROS**

⊗ CAV7111/296 ⊕ Repl. / Reem.CAV296 ● CAV796 ⊖ Repl. / Reem.CAV796 ⤴ Spin on / Roscado □ Cartridge / Cartucho ⚡ Power steering / Dirección asistida
⊕ Auxiliary circuit / Circuito auxiliar ⊕ Oil cooler / Refrigerador de aceite ⚙ Internal hydr. pump / Bomba hidráulica interna ⚡ External circuit / Circuito externo

Tractors Tractores	Engine Motor	1		2	3	4		
		Air / Aire		Oil	Fuel	Hydraulic / Hidráulico		
		Out. / Ext.	Inn. / Int.	Acetite	Combustible	Lift / Elev.		
IT Italian tractors / Tractores Italianos								
134V, 154S, 154V	AD3.152	60/161-142 (3310358M1)	60/162-142 (3595519M1)	60/96-2 □ (26540132, 1883258M91)		60/240-25 (3307250M91)	60/574-25 H (3300901M91)	
154								
154F		60/161-142 (3310358M1)	60/162-142 (3595519M1)			60/97-1 ⤴ (2654408, 1447082M91)	60/240-25 (3307250M91)	60/641-26 ⊕ (3530223M92)
164TF, 164TS, 164TV	AT3.152.4					60/240-25 (3307250M91)		
174, 184	A4.236			60/96-3 □ (26560090, 1896000M91)		60/240-25 (3307250M91)		
174F, 184F		60/161-142 (3310358M1)	60/162-142 (3595519M1)			60/97-2 ⤴ (2654403, 1447048M1)	60/641-26 ⊕ (3530223M92)	60/574-25 H (3300901M91)
174S, 174V, 184S							60/240-25 (3307250M91)	
194	A4.248			60/97-2 ⤴ (2654403, 1447048M1)	60/111-5 ⊗ (26560017, 836218M91)	60/240-25 (3307250M91)		
194F		60/161-142 (3310358M1)	60/162-142 (3595519M1)			60/641-26 ⊕ (3530223M92)	60/574-25 H (3300901M91)	
194S								
233	AD3.152			60/97-1 ⤴ (2654408, 1447082M91)	60/111-3 ⊕ (26561117, 3405418M1)	60/240-25 (3307250M91)		
234C/CF, 244CF								
253								
254, 254S	AT3.152.4	60/161-99 (1698683M1)	60/162-99 (1698684M1)					
263T								
264T		60/161-99 (1698683M1)	60/162-99 (1698684M1)			60/240-25 (3307250M91)	60/574-25 H (3300901M91)	
264TS								
273	A4.236			60/97-2 ⤴ (2654403, 1447048M1)		60/240-25 (3307250M91)		
274, 274S		60/161-99 (1698683M1)	60/162-99 (1698684M1)					
274C, 274CF								
274SK	A4.248	60/161-142 (3310358M1)	60/162-142 (3595519M1)			60/240-25 (3307250M91)		
283, 284							60/574-25 H (3300901M91)	
284S								
293, 294	A4.248							
294S		60/161-142 (3310358M1)	60/162-142 (3595519M1)			60/240-25 (3307250M91)		
294C								

Part numbers are quoted for reference purposes only.
Our parts and accessories are not original.

Las referencias originales tienen un propósito identificativo.
Nuestras piezas no son originales.



FILTERS FILTROS								
⊕ CAV7111/296 ⇔ Repl. / Reem.CAV296 ● CAV796 ⊕ Repl. / Reem.CAV796 ⤴ Spin on / Roscaado □ Cartridge / Cartucho ⊞ Power steering / Dirección asistida ⊙ Auxiliary circuit / Circuito auxiliar ⊗ Oil cooler / Refrigerador de aceite ⚡ Internal hydr. pump / Bomba hidráulica interna ⚡ External circuit / Circuito externo								
Tractors Tractores	Engine Motor	1		2	3	4		
		Air / Aire		Oil Aceite	Fuel Combustible	Hydraulic / Hidráulico		
		Out. / Ext.	Inn. / Int.			Lift / Elev.		
IT Italian tractors / Tractores Italianos								
333	AD3.152					60/240-25 (3307250M91)		
334V		60/161-142 (3310358M1)	60/162-142 (3595519M1)			60/641-26 (3530223M92)		
353, 353S						60/240-25 (3307250M91)	60/574-25 H (3300901M91)	
353LX		60/161-143 (3540046M1)	60/162-143 (3540047M1)					
354 SP/FP/AP/GE								
354F/V						60/641-26 (3530223M92)	60/625-11 (3551956M91)	
354VQ		60/161-142 (3310358M1)	60/162-142 (3595519M1)				60/574-25 H (3300901M91)	
356CF					60/97-1 ⤴ (2654408, 1447082M91)			
363			60/161-143 (3540046M1)	60/162-143 (3540047M1)			⇔ P06076 60/240-25 (3307250M91)	
363S						P06077 ⇔ 60/641-26 (3530223M92)	60/574-25 H (3300901M91)	
363LX	AT3.152.4	60/161-143 (3540046M1)	60/162-143 (3540047M1)					
364SP/FP/AP/GE								
364F/V		60/161-142 (3310358M1)	60/162-142 (3595519M1)			60/641-26 (3530223M92)	60/625-11 (3551956M91)	
364VQ								
366CF					60/111-5 ⊕ (26560017, 836218M91)			
367CF		60/161-143 (3540046M1)	60/162-143 (3540047M1)			⇔ P06076 60/240-25 (3307250M91)		
373					60/111-3 ⊕ (26561117, 3405418M1)	P06077 ⇔ 60/641-26 (3530223M92)	60/574-25 H (3300901M91)	
373S								
373LX		60/161-143 (3540046M1)	60/162-143 (3540047M1)					
374SP/FP/AP/GE								
374F/V/S		60/161-142 (3310358M1)	60/162-142 (3595519M1)			60/641-26 (3530223M92)		
374VQ							60/625-11 (3551956M91)	
376C, 376CF	A4.236	60/161-143 (3540046M1)	60/162-143 (3540047M1)	60/97-2 ⤴ (2654403, 1447048M1)				
		60/161-142 (3310358M1)	60/162-142 (3595519M1)			60/240-25 ⊕ (3307250M91)		
377		60/161-143 (3540046M1)	60/162-143 (3540047M1)			60/641-26 (3530223M92)		
		View master	View master					
383								
383LX		60/161-143 (3540046M1)	60/162-143 (3540047M1)			60/641-26 (3530223M92)	60/574-25 H (3300901M91)	
						⇔ P06076 60/240-25 (3307250M91)		
383S						P06077 ⇔ 60/641-26 (3530223M92)		

Part numbers are quoted for reference purposes only.
Our parts and accessories are not original.

Las referencias originales tienen un propósito identificativo.
Nuestras piezas no son originales.



FILTERS FILTROS									
⊕ CAV7111/296 ⊖ Repl. / Reem. CAV296 ● CAV796 ⊕ Repl. / Reem. CAV796 ⊕ Spin on / Roscado □ Cartridge / Cartucho ≡ Power steering / Dirección asistida ⊕ Auxiliary circuit / Circuito auxiliar ⊕ Oil cooler / Refrigerador de aceite ● Internal hyd. pump / Bomba hidráulica interna ● External circuit / Circuito externo									
Tractors Tractores	Engine Motor	1		2	3	4			
		Air / Aire		Oil Aceite	Fuel Combustible	Hydraulic / Hidráulico			
		Out. / Ext.	Inn. / Int.			Lift / Elev.			
IT Italian tractors / Tractores Italianos									
384SP/FP/AP/GE	A4.236	60/161-143 (3540046M1)	60/162-143 (3540047M1)	60/97-2 ⊕ (2654403, 1447048M1)	60/111-5 ⊕ (26560017, 836218M91)	60/641-26 (3530223M91)	60/574-25 H (3300901M91)		
384F/S/V		60/161-142 (3310358M1)	60/162-142 (3595519M1)			60/641-26 (3530223M91)	60/625-11 (3551956M91)		
384VQ		60/161-142 (3310358M1)	60/162-142 (3595519M1)			⊖ P04064 60/240-25 (3307250M91)	60/574-25 H (3300901M91)		
387	60/161-143 (3540046M1)	60/162-143 (3540047M1)	P04065 ⊖ 60/641-26 (3530223M91)						
	View master	View master							
393	A4.248	60/161-143 (3540046M1)	60/162-143 (3540047M1)			60/641-26 (3530223M91)		⊖ P06076 60/240-25 (3307250M91)	P06077 ⊖ 60/641-26 (3530223M91)
393LX									
393S									
393TLX	AT4.248	60/161-153 (3540051M1)	60/162-153 (3540052M1)						
394SP/FP/AP/GE	A4.248	60/161-143 (3540046M1)	60/162-143 (3540047M1)					60/641-26 (3530223M91)	
394F/S/V		60/161-142 (3310358M1)	60/162-142 (3595519M1)			60/111-3 ⊖ (26561117, 3405418M1)		60/240-25 ⊖ (3307250M91)	60/641-26 (3530223M91)
394C/CF		60/161-143 (3540046M1)	60/162-143 (3540047M1)						
394T	AT4.236	60/161-153 (3540051M1)	60/162-153 (3540052M1)					60/641-26 (3530223M92)	
396C/CF	A4.248	60/161-143 (3540046M1)	60/162-143 (3540047M1)						
396CT	AT4.236	60/161-153 (3540051M1)	60/162-153 (3540052M1)					60/240-25 ⊖ (3307250M91)	60/641-26 (3530223M92)
397	A4.248	60/161-143 (3540046M1)	60/162-143 (3540047M1)			⊖ P04064 60/240-25 (3307250M91)	60/574-25 H (3300901M91)		
						⊖ P04065 ⊖ 60/641-26 (3530223M92)			
397T	AT4.236	60/161-104 (3310355M91)	60/162-25 (26510228, 1093683M92)			60/641-26 (3530223M92)			
1007									

Part numbers are quoted for reference purposes only.
Our parts and accessories are not original.

Las referencias originales tienen un propósito identificativo.
Nuestras piezas no son originales.



FILTERS FILTROS

⊕ CAV7111/296 ⇔ Repl. / Reem.CAV296 ● CAV796 ⚡ Repl. / Reem.CAV796 ⚡ Spin on / Roscada □ Cartridge / Cartucho ⊕ Power steering / Dirección asistida
⊕ Auxiliary circuit / Circuito auxiliar ⊕ Oil cooler / Refrigerador de aceite ⚡ Internal hydr. pump / Bomba hidráulica interna ⚡ External circuit / Circuito externo

Tractors Tractores	Engine Motor	1		2	3	4			
		Air / Aire				Oil Aceite	Fuel Combustible	Hydraulic / Hidráulico	
		Out. / Ext.	Int. / Int.					Lift / Elev.	
IT Italian tractors / Tractores Italianos									
1014	A6.354.1	⇔ 12900159 60/161-60 (3638563M1)	60/162-25 (26510228, 1093683M92)	60/97-3 ⚡ (2654407, 1447031M1)	60/111-5 ⊕ (26560017, 836218M91) = 60/111-3 ⇔ (26561117, 3405418M1)	⇔ V8004 60/240-23 (1425418M1)	Lift arm Brazo de elevación 60/240-22 (1425411M91)		
1014	A6.354.4	12900160 ⇔ 60/161-104 (3310355M91)				V8005 ⇔ 60/641-26 (3530223M91)	Differential lock Bloqueo del dif. 60/240-26 (3302055M91)		
1024	A6.354.4	60/161-104 (3310355M91)	60/162-25 (26510228, 1093683M92)						
1104	A6.354.1	60/161-141 (3637417M1)						Lift Housing Carcasa elev. 60/240-27 (974535M2)	
1114	A6.354.4	60/161-60 (3638563M1)	60/162-25 (26510228, 1093683M92)					Lift / Levante 60/641-26 (3530223M91)	
1134	AT6.354.4	60/161-105 (1426451M91)	60/162-64 (1426450M91)					Lift arm Brazo de elevación 60/240-22 (1425411M91)	
2205	AD3.152					60/97-1 ⚡ (2654408, 1447082M91)		Differential lock Bloqueo del dif. 60/240-26 (3302055M91) Ht./Al. 130mm or / o 60/240-24 (1426462M91) Ht./Al. 80mm	
2210 2220	903.27 903.27T								
2230	1004.42	60/161-143 (3540046M1)	60/162-143 (3540047M1)			60/97-2 ⚡ (2654403, 1447048M1)	60/111-63 (3638291M1) = 60/111-25 Repl./Re.CAV 496		
3210SP/FP/GE	AD3.152					60/97-1 ⚡ (2654408, 1447082M91)			
3220SP/FP/AP/GE, 3225SP/FP/AP/GE	A4.236				60/111-5 ⊕ (26560017, 836218M91)	60/641-26 (3530223M91)	60/574-25 H (3300901M91)		
3315 3325 3330 3340 3350, 3355	903.27 903.27T 1004.40 1004.42 1004.40T	60/161-104 (0.010.3169.0)	60/162-25 (2.4249.130.7)	60/97-2 ⚡ (2654403, 1447048M1)	60/111-3 ⇔ (26561117, 3405418M1)		60/240-41 H (3619594M1)		

Part numbers are quoted for reference purposes only.
Our parts and accessories are not original.

Las referencias originales tienen un propósito identificativo.
Nuestras piezas no son originales.



FILTERS FILTROS							
⊕ CAV7111296 ⊕ Repl. / Reem. CAV296 ● CAV796 ⊕ Repl. / Reem. CAV796 Ⓢ Spin on / Roscada □ Cartridge / Cartucho ⊞ Power steering / Dirección asistida ⊙ Auxiliary circuit / Circuito auxiliar ⊗ Oil cooler / Refrigerador de aceite ⚡ Internal hydr. pump / Bomba hidráulica interna ⚡ External circuit / Circuito externo							
Tractors Tractores	Engine Motor	1 Air / Aire		2 Oil Aceite	3 Fuel Combustible	4 Hydraulic / Hidráulico	
		Out. / Exz.	Inn. / Int.			Lift / Elev.	
Chargers telescópicos / Carretillas elevadoras telescópicas							
8925, 8926, 8937, 8939 8925, 8926, 8937, 8939	1004.4 1004.42	60/161-118 (3901462M1) Ht./Al. 319mm	60/162-118 (3901463M1) Ht./Al. 305mm	60/97-2 Ⓢ (2654403, 1447048M1)	60/111-63 (3638291M1) =		
8925T, 8926T, 8937T, 8939T 8925T, 8926T, 8937T, 8939T	1004.4T 1004.40T	60/161-119 (3901464M1) Ht./Al. 359mm	60/162-119 (3901465M1) Ht./Al. 345mm	60/97-3 Ⓢ (2654407, 1447031M1)	60/111-25 Repl. / Reem. CAV 496		
Combines / Cosechadoras							
24, 27, 29, 29XP, 31, 31XP	AT6.354.4			60/97-3 Ⓢ (2654407, 1447031M1)			
31	AT6.354.4			60/96-15 (26540154, 1883287M91)	60/111-5 ⊕ (26560017, 836218M91) =		
186, 187, 206	A4.212 A4.236			60/96-3 (26560090, 1896000M91) or / o 60/97-1 Ⓢ (2654408, 1447082M91)	60/111-3 ⊕ (26561117, 3405418M1)		
240 430, 440	A4.236 A4.248			60/97-2 Ⓢ (2654403, 1447048M1) or / o 60/97-3 Ⓢ (2654407, 1447031M1)	60/111-5 ⊕ (26560017, 836218M91) = 60/111-3 ⊕ (26561117, 3405418M1) or / o 60/111-6 ● (26560602, 1896287M91) =		
307, 330	A4.236			60/97-2 Ⓢ (2654403, 1447048M1)			
400, 410, 415	A4.300	60/161-38 (26510148, 1420377M91) Ht./Al. 316mm or / o 60/161-86 (2874126) Ht./Al. 263mm		60/96-14 (26540153, 1883288M91)	60/111-5 ⊕ (26560017, 836218M91) =		60/574-14 ● (577492M91)
487	A4.248			60/96-3 (26560090, 1896000M91)	60/111-3 ⊕ (26561117, 3405418M1)		
500, 510, 515	A6.354	60/161-38 (26510148, 1420377M91) Ht./Al. 316mm or / o 60/161-86 (2874126) Ht./Al. 263mm		60/96-14 (26540153, 1883288M91) or / o 60/97-3 Ⓢ (2654407, 1447031M1)			60/240-7

Part numbers are quoted for reference purposes only.
Our parts and accessories are not original.

Las referencias originales tienen un propósito identificativo.
Nuestras piezas no son originales.



FILTERS FILTROS

⊕ CAV7111296 ⊕ Repl. / Reem.CAV296 ⊕ CAV796 ⊕ Repl. / Reem.CAV796 ⊕ Spin on / Roscado □ Cartridge / Cartucho ⊕ Power steering / Dirección asistida
⊕ Auxiliary circuit / Circuito auxiliar ⊕ Oil cooler / Refrigerador de aceite ⊕ Internal hydr. pump / Bomba hidráulica interna ⊕ External circuit / Circuito externo

Tractors Tractores	Engine Motor	1		2	3	4	
		Air / Aire		Oil Aceite	Fuel Combustible	Hydraulic / Hidráulico	
		Out. / Ext.	Inn. / Int.			Lift / Elev.	
Combines / Cosechadoras							
520, 525 620, 625	A6.354 A6.372	60/161-38 (26510148, 1420377M91)		60/96-14 (26540153, 1883288M91) or / o 60/97-3 ⊕ (2654407, 1447031M1)		60/240-29 (1851399M1)	
530, 535	A6.354.4			60/97-2 ⊕ (2654403, 1447048M1) or / o 60/97-3 ⊕ (2654407, 1447031M1)	60/111-5 ⊕ (26560017, 836218M91) = 60/111-3 ⊕ (26561117, 3405418M1)	60/240-29 (1851399M1)	Clutch Embrague 60/655-3 (1810539M91)
560, 565, 660, 665	AT6.354.4	60/161-41 (26510235, 1042412M91)					
740, 750 750	A6.372.4 AT6.354.4	60/161-41 (26510235, 1042412M91)	60/162-41 (1096475M91)				
760	AT6.354.4	60/161-60 (3638563M1) Ht. / Al. 394mm or / o 60/161-41 (26510235, 1042412M91) Ht. / Al. 416mm	60/162-25 (26510228, 1093683M92) 60/162-41 (1096475M91)	60/97-3 ⊕ (2654407, 1447031M1)			60/574-14 ⊕ (577492M91)
788	A4.270			60/96-3 (26560090, 1896000M91)	60/111-1 (32327, 1850450M2) + 60/111-8 (30242, 1881632M91)		
800, 805, 810, 815	A6.354.4						
820, 825, 830, 835, 840, 845	AT6.354.4	60/161-41 (26510235, 1042412M91)				60/240-29 (1851399M1)	
850, 855	AT6.354.4	60/161-60 (3638563M1) Ht. / Al. 394mm or / o 60/161-41 (26510235, 1042412M91) Ht. / Al. 416mm	60/162-25 (26510228, 1093683M92) 60/162-41 (1096475M91)	60/97-3 ⊕ (2654407, 1447031M1)	60/111-5 ⊕ (26560017, 836218M91) = 60/111-3 ⊕ (26561117, 3405418M1)		60/574-14 ⊕ (577492M91)
860, 865	AT6.354.4	60/161-41 (26510235, 1042412M91)	60/162-41 (1096475M91)	60/97-2 ⊕ (2654403, 1447048M1) or / o 60/97-3 ⊕ (2654407, 1447031M1)			
7250	620D				60/111-6 ⊕ (26560602, 1896287M91) = 60/111-4 ⊕ (26566602, 3405419M1)		
7252	620D	60/161-77 (3580723M1)	60/162-77 (3580724M1)	60/97-33 (V836662111)			
7254, 7256	634D						
7274, 7276, 7278	645D			60/97-34 (3637652M1)			

Part numbers are quoted for reference purposes only.
Our parts and accessories are not original.

Las referencias originales tienen un propósito identificativo.
Nuestras piezas no son originales.



FILTERS FILTROS

⊕ CAV7111296 ⊖ Repl. / Reem.CAV296 ● CAV796 ⊕ Repl. / Reem.CAV796 ⚡ Spin on / Roscado □ Cartridge / Cartucho ▣ Power steering / Dirección asistida
⊙ Auxiliary circuit / Circuito auxiliar ⊗ Oil cooler / Refrigerador de aceite ⚙ Internal hydr. pump / Bomba hidráulica interna ⚡ External circuit / Circuito externo

Tractors Tractores	Engine Motor	1		2	3	4			
		Air / Aire		Oil Aceite	Fuel Combustible	Hydraulic / Hidráulico			
		Out / Ext	Inn. / Int.			Lift / Elev.			
Industrial tractors / Palas retrocargadoras									
20B, 20E, 30E	AD3.152	60/161-12 (1688092M2)	60/162-12 (3824033M1)	60/97-1 ⚡ (2654408, 1447082M91)	60/111-5 ⊕ (26560017, 836218M91) = 60/111-3 ⊖ (26561117, 3405418M1)	60/655-3 ⚡ (1810539M91)	60/574-2 H (1052097M1)		
20D						60/655-4 (1810694M92)	60/574-1 H (1886135M1)		
30D									
30H							60/111-6 ● (26560602, 1896287M91) = 60/111-4 ⊕ (26566602, 3405419M1)	60/574-4 H (1662566M1)	
40								60/655-4 (1810694M92)	
40E						60/161-12 (1688092M2)	60/162-12 (3824033M1)		
50	AD4.203 A4.212 A4.236	60/161-3 (26510236, 880271M1)	60/162-3 (26510237, 1887575M91)	60/97-2 ⚡ (2654403, 1447048M1)	60/111-5 ⊕ (26560017, 836218M91) = 60/111-3 ⊖ (26561117, 3405418M1)	60/574-3 H (1883318M1) Ht. / Al. 62mm Ø 85mm			
50D						60/655-4 (1810694M92)	60/574-4 H (1662566M1) Ht. / Al. 74mm Ø 71mm		
50B	A4.236					60/655-1 ● (191855M4)			
50H, 50HX						60/641-3 (1810950M91)			
50E 50EX	A4.236 A4.248	60/161-78 (3824035M1)	60/162-78 (3824036M1)	60/111-6 ● (26560602, 1896287M91) = 60/111-4 ⊕ (26566602, 3405419M1)	60/655-5 (1687647M1)		60/574-4 H (1662566M1)		
60H	A4.248					60/641-3 (1810950M91)			
Fermec Series 700, 800, 900 Series	1004.4 1004.4T 1004.40T	60/161-24 (3595503M1)	60/162-23 (3595501M1)		60/111-5 ⊕ (26560017, 836218M91) = 60/111-3 ⊖ (26561117, 3405418M1)				

Part numbers are quoted for reference purposes only.
Our parts and accessories are not original.

Las referencias originales tienen un propósito identificativo.
Nuestras piezas no son originales.



FILTER DIMENSIONS
DIMENSIONES DE LOS FILTROS

Ref. Ref.	Ø x H L x l / A x H / A	Thread Rosca	Ref. Ref.	Ø x H L x l / A x H / A	Thread Rosca	Ref. Ref.	Ø x H L x l / A x H / A	Thread Rosca
60/161-1	104 x 232		60/162-41	103 x 282		60/240-28	103 x 177	
60/161-3	114 x 268		60/162-64	118 x 405		60/240-29	129 x 228	
60/161-12	174 x 315		60/162-77	151 x 381		60/240-39	127 x 139	
60/161-13	133 x 321		60/162-78	75 x 187		60/240-40	79 x 204	
60/161-14	180 x 359		60/162-97	112 x 287		60/240-41	50 x 155	
60/161-22	138 x 305		60/162-98	65 x 210		60/240-61	138 x 238	
60/161-23	177 x 282		60/162-99	89 x 198		60/240-85	x 98	
60/161-24	155 x 282		60/162-118	65 x 305		60/569-1	98 x 238	
60/161-25	177 x 394		60/162-119	75 x 345		60/574-1	50 x 40	
60/161-26	215 x 315		60/162-120	88 x 360		60/574-2	38 x 52	
60/161-27	212 x 330		60/162-121	105 x 385		60/574-3	86 x 63	
60/161-38	155 x 317		60/162-124	148 x 320		60/574-4	71 x 74	
60/161-41	174 x 416		60/162-125	150 x 500		60/574-7	50 x 205	
60/161-60	154 x 392		60/162-126	148 x 372		60/574-14	111 x 180	
60/161-63	127 x 238.5		60/162-127	150 x 370		60/574-21	84 x 56	
60/161-77	264 x 420		60/162-142	66 x 254		60/574-25	84 x 54.5	
60/161-78	132 x 327		60/162-143	84 x 319		60/574-26	47 x 99	
60/161-86	233 x 267		60/162-153	95 x 339		60/625-1	63 x 93	
60/161-95	114 x 365		60/162-165	114 x 382		60/625-2	60 x 96	
60/161-97	197 x 313		60/96-1	71 x 141		60/625-4	55 x 120	
60/161-98	67 x 120		60/96-2	65 x 115		60/625-5	140 x 166	
60/161-99	92 x 183		60/96-3	71 x 156		60/625-6	136 x 98	M42x2
60/161-100	127 x 274		60/96-14	95 x 116		60/625-7	137 x 240	
60/161-104	215 x 385		60/96-15	95 x 100		60/625-9	138 x 171	
60/161-105	202 x 420		60/97-61	140 x 175	1/2" - 16	60/625-11	109 x 170	
60/161-118	125 x 320		60/97-1	76 x 142	3/4" - 16	60/625-14	63.5 x 127.5	
60/161-119	149 x 360		60/97-2	93 x 143	3/4" - 16	60/641-3	135 x 228	
60/161-120	155 x 347		60/97-3	93 x 173	3/4" - 16	60/641-26	80 x 153	
60/161-121	194 x 400		60/97-33	110 x 149	M24X1.5	60/641-27	55 x 100	
60/161-124	152 x 280		60/97-34	106 x 272	M30x1.5	60/655-1	47 x 116	
60/161-125	282 x 520		60/97-43	93 x 117	13/16" - 16	60/655-2	44 x 88	
60/161-126	277 x 380		60/111-1	71 x 87		60/655-3	71 x 153	
60/161-127	265 x 420		60/111-2	80 x 71		60/655-4	72 x 160	
60/161-142	180 x 292		60/111-3	86 x 72		60/655-5	50 x 152	
60/161-143	142 x 330		60/111-4	84 x 112		60/4200-25	840 x 130 x 55	
60/161-153	165 x 344		60/111-5	86 x 72		60/4200-28	235 x 85 x 48	
60/161-165	220 x 403		60/111-6	84 x 112		60/4200-30	600 x 81 x 51	
60/162-1	72 x 203		60/111-8	71 x 79		60/4200-31	600 x 80 x 50	
60/162-3	52 x 220		60/111-25	84 x 160		60/4200-32	760 x 152 x 57	
60/162-12	74 x 213		60/111-63	84 x 160		60/4200-33	760 x 152 x 57	
60/162-13	75 x 294		60/111-202	84 x 188		60/4200-34	840 x 130 x 55	
60/162-14	90 x 194		60/240-7	93 x 144		60/4200-35	510 x 275 x 70	
60/162-22	60 x 197		60/240-22	80 x 185		60/4200-36	510 x 275 x 70	
60/162-23	85 x 230		60/240-23	74 x 154		60/4200-39	600 x 80 x 50	
60/162-25	86 x 358		60/240-24	70 x 80				
60/162-26	133 x 280		60/240-25	60 x 119				
60/162-27	117 x 330		60/240-26	70 x 129				
			60/240-27	63 x 68				

ADAPTATOR M42 / M42 ADAPTADOR

60/627-6
For filtro / Por filtro :
60/625-5, 60/625-6 & 60/625-7



Part numbers are quoted for reference purposes only.
Our parts and accessories are not original.

Las referencias originales tienen un propósito identificativo.
Nuestras piezas no son originales.