

Catálogo
Repuestos adaptables
TRACTORES
Massey Ferguson y
Motor Perkins





**PRODUCT
NEWS-SHEET**

PAGE : N°7613

DATE : 07/07

PERKINS PARTS

**Nouvelle disponibilité en short bloc (complet)
News availabilities of short bloc (complete)
Neue verfügbare Motorblock (Komplett)
Nieuwe beschikbare motorblok (kompleet)
Nuevas disponibilidades en motor bloqueo (completo)**

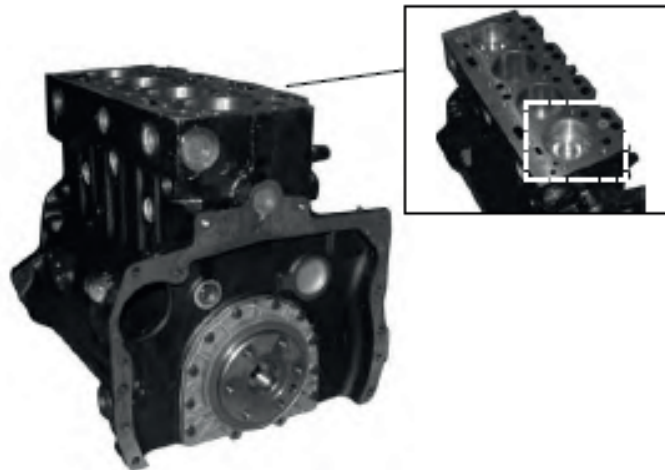

Short block Motorblock Motorblok Motor bloqueo	Piston Kolben Zulger Pistón	Model	Cylinders	Nominal HP
30/6001-5	-	A4.248	4	80
30/6001-6	-	A4.236		70

**Consultez nous pour tous renseignements complémentaires sur cette nouvelle gamme
Consult us for further information about this new range
Fragen Sie uns für nähere Angaben zu diesem Programm
Raadpleeg ons voor nadere inlichtingen omtrent dit gamma
Consultar nosotros para todas información complementarias con esta nueva gama**

*Les références des pièces sont indicatives.
Nos pièces ne sont pas d'origine.*

*Part numbers are quoted for reference purposes only.
Our parts and accessories are not original.*











**PRODUCT
NEWS-SHEET**

**PAGE : N°7616
DATE : 08/07**

MASSEY-FERGUSON PARTS

**Bouchons divers - caps (miscellaneous) - Verschiedene deckel -
verschillende doppen - Tapones (diversos)**

	Parts N°	OEM	Description Beschreibung Omschrijving Descripción		
233, 253, 254, 254S, 263, 264, 273, 274, 274S, 283, 284, 293, 294, 1104, 1114, 1134	30/105-82	977093M91	Bouchon rempl. mazout Fuel tank cap Tankdeckel Brandstofftankdop Tapón depósito		
352, 362, 675, 690, 698, 699, 1004, 1004T, 365, 375, 390, 390T, 398 (⇨B18009)	30/85-20	1682301M91	Bouchon d'huile boîte de vitesse Oil cap for gear box Öldeckel für Getriebe Olledop voor versnellingsbak Tapón de aceite con caja de cambios		
399, 3085, 3095, 3115, 3120, 3125, 3635, 3645, 3655 4260, 4270 (⇨K37008)	30/85-21	748219M1			
230, 240, 240 (⇨A20287), 243, 240S, 265S, 275, 275 (⇨P12018), 285S, 290, 290(⇨P06156), 375E (⇨P12018), 390(⇨P06156), 390E (⇨P06156), 396, 399, 650, 660, 680, 3085, 3095, 3120, 3125 3315, 3325, 3330, 3340, 3350, 3355 V/S/F 3635, 3645, 3655 4215, 4220, 4225, 4235, 4240, 4245, 4255, 4260, 4265 (⇨K37008), 4270, 4315, 4320, 4325, 4335, 4345, 4355, 4360, 4365, 4370 5425, 5435, 5445, 5455, 5465 6160, 6170, 6180, 6235, 6245, 6255, 6260, 6265, 6270, 6280, 6290, 6445, 6455, 6460, 6465, 6470, 6475, 6480 7465, 7475, 7480 8110, 8120, 8130, 8210, 8220	30/85-22	3641889M1	Bouchon huile moteur Oil filter cap Ölfilterdeckel Oliefilterdop Tapón aceite		

Les références des pièces sont indicatives.
Nos pièces ne sont pas d'origine.

Part numbers are quoted for reference purposes only.
Our parts and accessories are not original.





**PRODUCT
NEWS-SHEET**

PAGE : N°7597
DATE : 06/07

MASSEY-FERGUSON PARTS

**REFROIDISSEUR D'HUILE - OIL COOLER - ÖLKÜLHER -
OLIE KOELER - REFRIGERADOR ACEITE**

	N° de construction <i>Build number</i>	Ref.	
A4236	LD, LJ, LH	30/6097-3 (P2486A219)	
1004.4	AA, AB, AE, AJ, AK, AQ, AR, AS		

Les références des pièces sont indicatives.
Nos pièces ne sont pas d'origine.

*Part numbers are quoted for reference purposes only.
Our parts and accessories are not original.*





PRODUCT
NEWS-SHEET

PAGE : N°7577
DATE : 05/07

MASSEY-FERGUSON PARTS

Radiateur - Radiator - Kühler - Radiator - Radiador

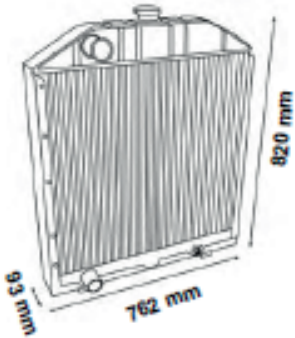
	Ref.	OEM		
8140, 8150, 8160	30/1 50-160	371318 1M4 371318 1M3		

Les références des pièces sont indicatives.
Nos pièces ne sont pas d'origine.

Part numbers are quoted for reference purposes only.
Our parts and accessories are not original.





**PRODUCT
NEWS-SHEET**

PAGE : N°7575
DATE : 04/07

MASSEY-FERGUSON PARTS

Démarreurs - Starter motors - Anlasser - Startmotors - Motores de arranque

Applications <i>Applications</i>	Réf. <i>Ref.</i>	OEM	
Massey-Ferguson			
Motores / Engines / Motors / Motoras Perkins A3-152, AD3-152, A4-182, A4-203, AD4-203 65, 133, 134, 135, 140, 145, 148, 152, 154, 155, 158, 165/1, 230, 233, 234, 235, 240, 245, 250, 253, 254, 255, 260, 263, 264, 350, 353, 355, 360 363, 364, 550, 560	62/930-217 (Iskra) Avec réducteur With reducer	1680065M3 1868283M5 3597371M1 3597426M3 3763363M91	3x127  10Z 245
	New 62/930-218 (Magnetron) Avec réducteur With reducer 12V 3,0KW		3x146  10Z 205

Les références des pièces sont indicatives.
Nos pièces ne sont pas d'origine.

Part numbers are quoted for reference purposes only.
Our parts and accessories are not original.



**PRODUCT
NEWS-SHEET**

PAGE : N°7561
DATE : 12/06

MASSEY-FERGUSON PARTS

**Siège (Pour tracteurs étroits) - Seat (Narrow tractors) - Sitze (Schmalspurschlepper) -
Zitting (Smalspoor-tractoren) - Asiento (Tractores estrechos)**



Caractéristiques techniques :
- Cuvette noir en acier
- Fixation centrale

Technical data :
- Black iron covering
- Central fitting

Technische Daten :
- Schwarzer Stahlblech
- Zentralbefestigung

Kenmerken :
- Zwart metaal
- Centrale bevestiging

Características técnicas :
- Acabado negro metálico
- Montaje central

61/830-611

(181313M91, 891869M91)

20, 25, 35, 35X, 65, 100, 135, 165, 168, 175, 178,
185, 188, 230, 235, 240, 245, 265, 275, 290, 765, 825,
835, 865, 1000, TE20, TEA20, TED20, TEF20, TO20

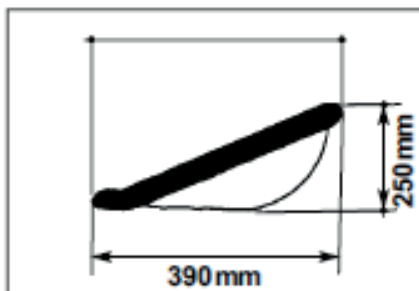

Les références des pièces sont indicatives.
Nos pièces ne sont pas d'origine.

Part numbers are quoted for reference purposes only.
Our parts and accessories are not original.





PRODUCT
NEWS-SHEET

PAGE : N°7 549
DATE : 10/06

MASSEY-FERGUSON PARTS

Radiateur - Radiator - Kühler - Radiator - Radiador

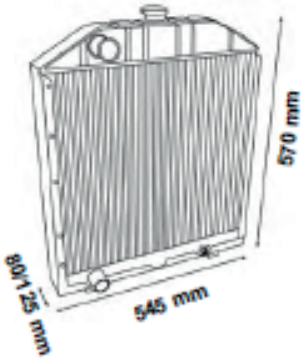
	Ref.	OEM		
<p>3050, 3060, 3065, 6120, 6130, 6140</p> <p>Avec cap ot plongeant With highvisibility bonnet Mit tiefer Motorhaube Met hellende motorkap Con capó desde arriba</p>	30/1 50-156	3618137M1		

Les références des pièces sont indicatives.
Nos pièces ne sont pas d'origine.

Part numbers are quoted for reference purposes only.
Our parts and accessories are not original.



**PRODUCT
 NEWS-SHEET**

**PAGE : N° 7530
 DATE : 07/06**

MASSEY-FERGUSON PARTS

Filtre de cabine - Cab filters - Kabinenfilter - Kabinesfilter - Filtro de cabina



	Ref.	OEM	Dimensions Size Abmessungen Afmetingen Dimensiones
274SK, 284S, 294S, 1014, 1024	30/4200-51	3301748M91	720mmx158mmx55mm

Les références des pièces sont indicatives.
 Nos pièces ne sont pas d'origine.

Part numbers are quoted for reference purposes only.
 Our parts and accessories are not original.





**PRODUCT
NEWS-SHEET**

PAGE : N° 7529
DATE : 07/06

MASSEY-FERGUSON PARTS

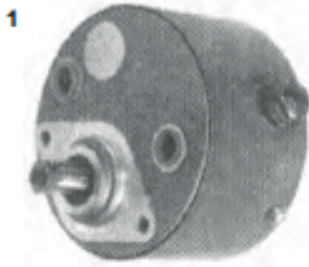
Pompe de direction - Steering pump - Lenkungs Pumpe - Stuurpomp - Bomba de dirección



	Fig. Abb. Afb. Fig.	Ref.	OEM	CC	
Industriel 40E, 20F 230, 240, 340, 342, 352, 355, 356, 360	1	30/570-13	1695922M91 3772716M91 3774041M91 3774614M91		
699	2	30/570-31	1693261M91 3903271M91	10	Gauche - Left - Links -Izquierda

Les références des pièces sont indicatives.
Nos pièces ne sont pas d'origine.

Part numbers are quoted for reference purposes only.
Our parts and accessories are not original.







**PRODUCT
NEWS-SHEET**

**PAGE : N° 7434
DATE : 08/05**

MASSEY-FERGUSON PARTS

**Amortisseur de torsion - Torsion damper - Torsiondämpfer - Torsiedemper -
Amortiguador de torsión**

	Parts N°	Dimensions	
4245, 4255, 4260, 4265, 4270 (⇒J46101) Powershuttle	30196-34 (3815739M2)	25Z 38,2 x 41,5	
4225, 4235, 4245, 4255, 4260, 4265, 4270 (J46102⇒) 4325, 4335, 4345, 4355, 4360, 4365, 4370 Powershuttle	30196-35 (3820069M1)	25Z 38,2 x 41,5	
6485, 6490, 6495, 8210, 8220, 8240, 8250 Dynashift Avec inverseur sous couple With power shuttle Mit hydraulischem Wender Mit hydraulische omkeerbak Con inversor automático	30196-36 (3793648M1)	26Z 39 x 42,5	

Les références des pièces sont indicatives.
Nos pièces ne sont pas d'origine.

Part numbers are quoted for reference purposes only.
Our parts and accessories are not original.



**INDEX
INDICE**

ALTERNATORS	399-410	ABRAZADERAS DE MANGUITO	154
AUXILIARY DRIVE	105	ACOPLAMIENTOS HIDRÁULICOS	373
AUXILIARY HYDRAULIC PUMPS	379	AFORADORES DE DEPÓSITO	194-195
BALANCER UNIT	112-115	ALTERNADORES	399-410
BOLTS	314-320, 324	ALZAMIENTO HIDRÁULICO	383-387
BRAKE CABLES	309-310	AMORTIGUADORES	430
BRAKE CYLINDERS	311-313	ASIENTOS	429
BRAKES	300-308		
CAB DAMPERS	439	BALANCINES	78-81
CAB GLASS	440-455	BARRAS DEL TERCER PUNTO	388-390
CAB HEATING	434	BIELAS Y PIEZAS RELACIONADAS	32-40
CENTRE HOUSING	281-282	BOMBINES DE ALIMENTACIÓN	117-120
CLUTCH CABLES	217	BOLAS PALANCA DE VELOCIDADES	272
CLUTCH ASSEMBLIES & PLATES	218-236	BOMBAS DE ACEITE	108-111
CLUTCH CONTROL	240	BOMBAS DE AGUA	131-140
CLUTCH MASTER AND SLAVE CYLINDERS	240	BOMBAS DE DIRECCIÓN	367
CONNECTING RODS & RELATED PARTS	32-40	BOMBAS HIDRÁULICAS	368-369
CORE PLUGS	31	BOMBAS HIDRÁULICAS AUXILIARES	379
CRANKSHAFT & RELATED PARTS	11-30	BOMBAS INTERNAS DEL ALZAMIENTO HIDRÁULICO	374
CROSS REFERENCES	456	BRAZOS DE DIRECCIÓN	345-349
CYLINDER HEAD PARTS	61-77		
DECAL SETS	427-428	CABLES DE EMBRAGUE	217
DERIVATIVE APPLICATION CHART	9	CABLES DE FRENO	309-310
DIFFERENTIAL	283-289	CABLES DE PARO Y ACELERADOR	123-125
DIPSTICK	107	CABLES DEL CUENTAHORAS	201
ENGINE GASKET SETS	82-90	CAJA CENTRAL	281-282
ENGINE OVERHAUL KITS	41-42	CAJA DE TRANSFERENCIA	366
EXHAUST	168-172	CAJAS DE HERRAMIENTAS	437
EXHAUST ELBOW	169	CALANDRAS	424
EXHAUST MANIFOLDS	168	CALANDRAS	426
FAN BLADES	154	CALENTADOR DE CABINA	434
FENDERS	425	CALENTADORES	116
FILTERS	173-193	CAMISAS	43-59
FLEXIBLE DRIVE	201	CASQUILLO DE DESGASTE	31
FLYWHEEL ASSEMBLIES	232	CIGÜEÑALES Y PIEZAS RELACIONADAS	11-30
FRONT AXLE (4 WD)	352-365	CILINDROS DE FRENOS	311-313
FRONT AXLE (2 WD)	322-334	CODOS DE ESCAPE	169
FRONT WHEELS (2 WD)	321	COLECTORES DE ESCAPE	168
FRONT GRILLE	426	CRISTALES DE CABINA	440-455
FUEL PIPES	130	CULATAS Y PIEZAS ANEXAS	61-77
FUEL PUMPS	117-120		
FUEL SENDER UNITS	194-195	DEPÓSITOS Y ACCESORIOS RELACIONADOS	121-122
FUEL SYSTEM	129	DIFERENCIAL	283-289
FUEL TANKS AND RELATED PARTS	121-122	DIRECCIÓN	350-351
GAS STRUTS	430	DIRECCIÓN ASISTIDA	370-372
GEAR LEVER PARTS	272-274	DISTRIBUCIÓN	93-104
GLAZING RUBBER AND DRAFT EXCLUDERS	439	DISTRIBUIDORES HIDRÁULICOS	381
HEATING PLUGS	116		
HOSE CLIPS	154	EJE DE TDF	275-279
HOSES (RADIATOR)	155-167	EJE DELANTERO 4RM	352-365
HYDRAULIC COUPLING	373	EMBRAGUE	218-240
HYDRAULIC LIFT	383-387	EMBRAGUE DE LA TDF INDEPENDIENTE	280
HYDRAULIC LIFT PUMPS	374-378	ENGANCHE INFERIOR - BRAZO DE ALZAMIENTO	391
		EQUILIBRADOR DE MONTAJE FRONTAL	112-115
		ESCOBILLAS DEL LIMPIAPARABRISAS	435
		ESTABILIZADORES	392-394
		FILTROS DE AIRE - BAÑO DE ACEITE	191
		FILTROS	173-189
		FILTROS AIRE DE CABINA	192

Part numbers are quoted for reference purposes only.
Our parts and accessories are not original.

Las referencias originales tienen un propósito identificativo.
Nuestras piezas no son originales.



**INDEX
INDICE**

HYDRAULIC PUMPS	368-369	GUARDABARROS	425
HYDRAULIC SPOOL VALVES	381	GUARDAPOLVOS PALANCAS DE CAMBIOS	273
INDEPENDENT P.T.O. GEAR	280	HORQUILLAS Y CAJAS NIVELADORAS	395-398
INDEX	1, 2	INDICE	1-2
INJECTOR NOZZLES	126-128	INSTRUMENTOS	196-200
INTERIOR TRIMS	439	INTERRUPTORES VARIOS	202-209
LANDINI APPLICATION CHARTS	10	JUEGOS COMPLETOS DE REPARACIÓN DE MOTOR	41-42
LAYCOCK CLUTCHES (SPARE PARTS)	237-239	JUEGOS DE CALCOMANIA	427-428
LEVELLING BOX	395-398	JUEGOS DE REPARACIÓN DE VÁLVULAS	60
LIFT ISOLATOR VALVE	382	JUEGOS DE SEGMENTOS	43-59
LIGHTING	210-216	JUNTAS DE MOTOR	82-90
LINERS	43-59	LLANTAS DELANTERAS 2 RM	321
LOADER & BACKHOE RAM SEAL KITS	372	LOCTITE®	91-92
LOCKS & HANDLES	436-437	LUCES	210-216
LOCTITE®	91-92	MANDO AUXILIAR DE DISTRIBUCIÓN	105
LOWER LNK ARM	391	MANGUITOS DEL FILTRO DE AIRE	190
MIRRORS	438	MOTOR LIMPIAPARABRISAS	434
OIL FILLER CAP	106	MOTORES DE ARRANQUE	411-423
OIL PUMPS	108-111	ORBITROL	379
ORBITROL	379	PALANCAS DE CAMBIOS Y ACCESORIOS	274
PADNT	431-433	PIEZAS DE RECAMBIO PARA BOMBA HIDRÁULICA	375-378
PANELS	424	PIEZAS DEL EJE DELANTERO 2 RM	322-334
PISTONS, RING SETS & LINERS	43-59	PIEZAS DEL PALIER TRASERO	290-299
POWER STEERING	370	PIEZAS PARA BOMBA HIDRÁULICA	380
PTO	275-279	PINTURA	431-433
RADIATORS & HOSES	155-167	PISTONES	43-59
REAR AXLE	290-299	POMOS Y CERRADURAS	436-437
RING SETS	43-59	PREFIL DE GOMA PARA CRISTALES DE CABINA	439
ROCKER SHAFTS & ARMS	78-81	PREFILTROS DE AIRE	191,193
SEATS	429	RADIADORES Y MANGUITOS	155-167
SELECTOR FORKS	270-271	RETROVISORES	438
SILENCERS	170-171	RÓTULAS Y BARRAS DE DIRECCIÓN	335-344
STABILISERS	392-394	SILENCIOSOS	170-172
STARTERS	411-423	SILENT-BLOCK DE CABINA	439
STEERING	345-351	SISTEMA DE COMBUSTIBLE	129-130
STEERING CYLINDER SEAL KITS	371-372	TABLA DE CORRESPONDANCIAS LANDINI	10
STEERING PUMPS	367	TABLA PARA MODELOS DERIVADOS (USO SOBRE PIEZAS DE MOTOR)	9
STOP CABLES	123	TAPÓN ACEITE	106
SWITCHES	202-209	TAPONES DEL BLOQUE	31
TANK DAMPER	121	TERMOSTATOS Y CORREAS	141-153
THERMOSTATS & V-BELTS	141-153	TOBERAS DE INYECTOR	126-128
THROTTLE CABLES	123-125	TORNILLOS Y TUERCAS	314-320
TIE RODS & SOCKETS	335-344	TRACTORES Y MOTORES, TABLA DE APLICACIONES	3-8
TIMING GEAR	93-104	TRANSMISIÓN	241-271
TOOL BOXES	437	VÁLVULA DERIVACIÓN DEL ALZAMIENTO	382
TOP LNKs	388-390	VARILLAS NIVEL DE ACEITE	107
TRACTOR AND ENGINE APPLICATION CHARTS	3-8	VENTILADORES	154
TRANSFER GEARBOX	366	VOLANTES DE MOTOR	232
TRANSMISSION	241-269		
VALVETRAIN KITS	60		
V-BELTS	141-153		
WATER PUMPS	131-140		
WEAR SLEEVE	31		
WIPER BLADES	435		
WIPER MOTORS	434		

Part numbers are quoted for reference purposes only.
Our parts and accessories are not original.

Las referencias originales tienen un propósito identificativo.
Nuestras piezas no son originales.



TRACTOR AND ENGINE APPLICATION CHARTS
TRACTORES Y MOTORES, TABLA DE APLICACIONES

Tractors <i>Tractores</i>	Engine <i>Motor</i>	Cyl. <i>Cil.</i>	Bore mm <i>Dia. mm</i>	Tractors <i>Tractores</i>	Engine <i>Motor</i>	Cyl. <i>Cil.</i>	Bore mm <i>Dia. mm</i>
Series TE20 Series				Series 100 Series			
TEA 20	85mm Petrol	4	85.00	174S	A4.236	4	98.48
TED 20	85mm VO	4	85.00	174V	A4.236	4	98.48
TEF 20	20C	4	80.98	175	A4.236	4	98.48
TEH 20	85mm LO	4	85.00	175S	A4.236	4	98.48
Series 35 Series				178	A4.248	4	101.05
25	A4.99	4	76.20	184	A4.236	4	98.48
25	A4.107	4	79.38	184F	A4.236	4	98.48
30	A4.107	4	79.38	184S	A4.236	4	98.48
FE 35	23C	4	84.14	185	A4.248	4	101.05
35	87mm Petrol	4	87.00	188	A4.248	4	101.05
35	A3.144	3	88.92	194	A4.248	4	101.05
35	A3.152	3	91.49	194C	A4.248	4	101.05
65	A4.192	4	88.92	194F	A4.248	4	101.05
65	A4.203	4	91.49	194S	A4.248	4	101.05
65	AD4.203	4	91.49	Series 200 Series			
Series 100 Series				230	AD3.152	3	91.49
122	A4.99	4	76.20	233	AD3.152	3	91.49
130	A4.107	4	79.38	234C	AD3.152	3	91.49
133	A3.144	3	88.92	234CF	AD3.152	3	91.49
133	AD3.152	3	91.49	234S	AD3.152	3	91.49
134C	AD3.152	3	91.49	235	AD3.152	3	91.49
134V	AD3.152	3	91.49	240	AD3.152	3	91.49
135	87mm Petrol	4	87.00	244CF	AD3.152	3	91.49
135	A3.144	3	88.92	245	AD3.152	3	91.49
135	AD3.152	3	91.49	250	AD3.152	3	91.49
135	AG3.152	3	91.49	253 (Italy)	AD3.152	3	91.49
135V	AD3.152	3	91.49	253 (UK)	AT3.152.4	3	91.49
140	AD3.152	3	91.49	254	AD3.152	3	91.49
145	AD3.152	3	91.49	254C	AD3.152	3	91.49
145S	AD3.152	3	91.49	254CF	AD3.152	3	91.49
145V	AD3.152	3	91.49	254S	AD3.152	3	91.49
148	AD3.152	3	91.49	255	AD3.152	3	91.49
150	AD3.152	3	91.49	255 (USA)	A4.236	4	98.48
152	AD3.152	3	91.49	260	AD4.203	4	91.49
152F	AD3.152	3	91.49	263 (UK)	903.27T	3	95.00
152S	AD3.152	3	91.49	263T (Italy)	AT3.152.4	3	91.49
152V	AD3.152	3	91.49	264T	AT3.152.4	3	91.49
154	AD3.152	3	91.49	264TCF	AT3.152.4	3	91.49
154C	AD3.152	3	91.49	264TS	AT3.152.4	3	91.49
154F	AD3.152	3	91.49	265	A4.236	4	98.48
154S	AD3.152	3	91.49	273	A4.236	4	98.48
154V	AD3.152	3	91.49	274	A4.236	4	98.48
155	AD4.203	4	91.49	274C	A4.236	4	98.48
158	AD4.203	4	91.49	274CF	A4.236	4	98.48
158F	AD4.203	4	91.49	274S	A4.236	4	98.48
158S	AD4.203	4	91.49	274SK	A4.236	4	98.48
158V	AD4.203	4	91.49	275	A4.236	4	98.48
164TF	AT3.152.4	3	91.49	275E	A4.236	4	98.48
164TS	AT3.152.4	3	91.49	275E	A4.41	4	101.05
164TV	AT3.152.4	3	91.49	283	A4.236	4	98.48
165	AD4.203	4	91.49	284	A4.236	4	98.48
165	A4.212	4	98.48	284S	A4.236	4	98.48
168	A4.236	4	98.48	285	A4.248	4	101.05
168F	A4.236	4	98.48	285 (USA)	A4.318	4	114.31
168S	A4.236	4	98.48	285 (USA)	A4.318.2	4	114.31
174	A4.212	4	98.48	290	A4.248	4	101.05
174	A4.236	4	98.48	290E	A4.248	4	101.05
174C	A4.212	4	98.48	290E	A4.41	4	101.05
174C	A4.236	4	98.48	293	A4.248	4	101.05
174F	A4.236	4	98.48	294	A4.248	4	101.05
				294C	A4.248	4	101.05
				294S	A4.248	4	101.05
				298	A4.318.2	4	114.31

Part numbers are quoted for reference purposes only.
Our parts and accessories are not original.

Las referencias originales tienen un propósito identificativo.
Nuestras piezas no son originales.



TRACTOR AND ENGINE APPLICATION CHARTS
TRACTORES Y MOTORES, TABLA DE APLICACIONES

Tractors <i>Tractores</i>	Engine <i>Motor</i>	Cyl. <i>Cil.</i>	Bore mm <i>Dia. mm</i>	Tractors <i>Tractores</i>	Engine <i>Motor</i>	Cyl. <i>Cil.</i>	Bore mm <i>Dia. mm</i>
Series 300 Series				Series 300 Series			
333	AD3.152	3	91.49	374SP	A4.236	4	98.48
334V	AD3.152	3	91.49	374SP(X)	A4.236 (Blue)	4	98.48
340	AD3.152	3	91.49	374SP(X)	1004.40 (Green)	4	100.00
342	AD3.152	3	91.49	374SQ	A4.236	4	98.48
350	AD3.152	3	91.49	374V	A4.236	4	98.48
352	AT3.152.4	3	91.49	374VQ	A4.236	4	98.48
353	AD3.152	3	91.49	375	A4.236	4	98.48
353LX	AD3.152	3	91.49	375E	A4.236	4	98.48
353S	AD3.152	3	91.49	375E	A4.41	4	101.05
354AP	AD3.152	3	91.49	376C	A4.236	4	98.48
354AQ	AD3.152	3	91.49	376CF	A4.236	4	98.48
354F	AD3.152	3	91.49	376XCF	A4.236	4	98.48
354FP	AD3.152	3	91.49	377	A4.236	4	98.48
354FP(X)	AD3.152	3	91.49	382N	A4.248	4	101.05
354FQ	AD3.152	3	91.49	383	A4.236	4	98.48
354GE	AD3.152	3	91.49	383LX	A4.236	4	98.48
354GE(X)	AD3.152	3	91.49	383S	A4.236	4	98.48
354S	AD3.152	3	91.49	384AP	A4.236	4	98.48
354SP	AD3.152	3	91.49	384AP(X)	A4.236	4	98.48
354SP(X)	AD3.152	3	91.49	384AQ	A4.236	4	98.48
354SQ	AD3.152	3	91.49	384F	A4.236	4	98.48
354V	AD3.152	3	91.49	384FP	A4.236	4	98.48
354VQ	AD3.152	3	91.49	384FP(X)	A4.236	4	98.48
355	AT3.152.4	3	91.49	384FQ	A4.236	4	98.48
356CF	AD3.152	3	91.49	384GE	A4.236	4	98.48
360	AT3.152.4	3	91.49	384GE(X)	A4.236	4	98.48
362	A4.236	4	98.48	384S	A4.236	4	98.48
362N	A4.236	4	98.48	384SP	A4.236	4	98.48
363	AT3.152.4	3	91.49	384SP(X)	A4.236	4	98.48
363LX	AT3.152.4	3	91.49	384SQ	A4.236	4	98.48
363S	AT3.152.4	3	91.49	384V	A4.236	4	98.48
364AP	AT3.152.4	3	91.49	384VQ	A4.236	4	98.48
364AQ	AT3.152.4	3	91.49	387	A4.236	4	98.48
364CF	AT3.152.4	3	91.49	390	A4.248	4	101.05
364F	AT3.152.4	3	91.49	390E	A4.248	4	101.05
364FP	AT3.152.4	3	91.49	390E	A4.41	4	101.05
364FQ	AT3.152.4	3	91.49	390T	AT4.236	4	98.48
364GE	AT3.152.4	3	91.49	393	A4.248	4	101.05
364S	AT3.152.4	3	91.49	393LX	A4.248	4	101.05
364SP	AT3.152.4	3	91.49	393S	A4.248	4	101.05
364SQ	AT3.152.4	3	91.49	393TLX	AT4.236	4	98.48
364V	AT3.152.4	3	91.49	394AP	A4.248	4	101.05
364VQ	AT3.152.4	3	91.49	394AP(X)	A4.248 (Blue)	4	101.05
365	A4.236	4	98.48	394AP(X)	1004.42 (Green)	4	103.00
366CF	AT3.152.4	3	91.49	394AQ	A4.248	4	101.05
367CF	A4.236	4	98.48	394C	A4.248	4	101.05
372N	A4.236	4	98.48	394F	A4.248	4	101.05
373	A4.236	4	98.48	394FP	A4.248	4	101.05
373LX	A4.236	4	98.48	394FP(X)	A4.248 (Blue)	4	101.05
373S	A4.236	4	98.48	394FP(X)	1004.42 (Green)	4	103.00
374AP	A4.236	4	98.48	394FQ	A4.248	4	101.05
374AP(X)	A4.236 (Blue)	4	98.48	394GE	A4.248	4	101.05
374AP(X)	1004.40 (Green)	4	100.00	394GE(X)	A4.248 (Blue)	4	101.05
374AQ	A4.236	4	98.48	394GE(X)	1004.42 (Green)	4	103.00
374F	A4.236	4	98.48	394H	A4.248	4	101.05
374FP	A4.236	4	98.48	394S	A4.248	4	101.05
374FP(X)	A4.236 (Blue)	4	98.48	394SP	A4.248	4	101.05
374FP(X)	1004.40 (Green)	4	100.00	394SP(X)	A4.248 (Blue)	4	101.05
374FQ	A4.236	4	98.48	394SP(X)	1004.42 (Green)	4	103.00
374GE	A4.236	4	98.48	394SO	A4.248	4	101.05
374GE(X)	A4.236 (Blue)	4	98.48	394TAQ	AT4.236	4	98.48
374GE(X)	1004.40 (Green)	4	100.00	396	1006.6	6	100.00
374H	A4.236	4	98.48	396C	A4.248	4	101.05
374S	A4.236	4	98.48	396CF	A4.248	4	101.05

Part numbers are quoted for reference purposes only.
Our parts and accessories are not original.

Las referencias originales tienen un propietario identificativo.
Nuestras piezas no son originales.



TRACTOR AND ENGINE APPLICATION CHARTS
TRACTORES Y MOTORES, TABLA DE APLICACIONES

Tractors Tractores	Engine Motor	Cyl. Cil.	Bore mm Dia. mm	Tractors Tractores	Engine Motor	Cyl. Cil.	Bore mm Dia. mm
Series 300 Series				Series 2600 Series			
396CT	AT4.236	4	98.48	2620	A6.354.4	6	98.48
397	A4.248	4	101.05	2625	A6.354.4	6	98.48
397T	AT4.236	4	98.48	2640	A6.354.4	6	98.48
398	AT4.236	4	98.48	2645	A6.354.4	6	98.48
399	A6.354.4	6	98.48	2675	A6.354.4	6	98.48
399	1006.6	6	100.00	2680	AT6.354.4	6	98.48
Series 500 Series				Series 2700 Series			
550	AD3.152	3	91.49	2705	AT6.354.4	6	98.48
560	AD4.203	4	91.49	2720	AT6.354.4	6	98.48
565	A4.236	4	98.48	2725	AT6.354.4	6	98.48
575	A4.236	4	98.48	Series 3000 Series			
590	A4.248	4	98.48	3050	A4.236	4	98.48
592	A4.318	4	114.31	3055	A4.248	4	101.05
592	A4.318.2	4	114.31	3060	A4.248	4	101.05
595	A4.318	4	114.31	3065	AT4.236	4	98.48
595	A4.318.2	4	114.31	3065S	AT4.236	4	98.48
Series 600 Series				3070	AT4.236	4	98.48
675	A4.236	4	98.48	3075	1004.4T	4	100.00
690	A4.248	4	101.05	3080	A6.354.4	6	98.48
698	A4.318.2	4	114.31	3085	1006.6	6	100.00
698T	AT4.236	4	98.48	3090	A6.354.4	6	98.48
699	A6.354.4	6	98.48	3095	1006.6	6	100.00
Series 700-800 Series				Series 3100 Series			
765	AD4.203	4	91.49	3115	1006.6	6	100.00
825	A4.107	4	79.38	3120	1006.6T	6	100.00
835	23C	4	84.14	3120T	1006.6T	6	100.00
865	A4.203	4	91.49	3125	1006.6T	6	100.00
Series 1000 Series				3140	1006.6T	6	100.00
1004	A4.318.2	4	114.31	Series 3200 & 3300 Series			
1004T	AT4.236	4	98.48	3210FP(X)	AD3.152	3	91.49
1007	AT4.236	4	98.48	3210GE(X)	AD3.152	3	91.49
1014	A6.354.1	6	98.48	3210SP(X)	AD3.152	3	91.49
1014	A6.354.4	6	98.48	3220AP(X)	A4.236 (Blue)	4	98.48
1024	A6.354.4	6	98.48	3220AP(X)	1004.40 (Green)	4	100.00
1080	A4.318	4	114.31	3220FP(X)	A4.236 (Blue)	4	98.48
1085	A4.318	4	114.31	3220FP(X)	1004.40 (Green)	4	100.00
1100	A6.354	6	98.48	3220GE(X)	A4.236 (Blue)	4	98.48
1104	A6.354.1	6	98.48	3220GE(X)	1004.40 (Green)	4	100.00
1105	ATC6.354.1	6	98.48	3220SP(X)	A4.236 (Blue)	4	98.48
1114	A6.354.4	6	98.48	3220SP(X)	1004.40 (Green)	4	100.00
1130	AT6.354	6	98.48	3225AP(X)	A4.236	4	98.48
1134	AT6.354.4	6	98.48	3225FP(X)	A4.236	4	98.48
1135	AT.6354.1	6	98.48	3225GE(X)	A4.236	4	98.48
1200	A6.354.1	6	98.48	3225SP(X)	A4.236	4	98.48
1250	A6.354.4	6	98.48	3235AP(X)	A4.248 (Blue)	4	101.05
Series 2200 Series				3235AP(X)	1004.42 (Green)	4	103.00
2205	AD3.152	3	91.49	3235FP(X)	A4.248 (Blue)	4	101.05
2210	903.27	3	95.00	3235FP(X)	1004.42 (Green)	4	103.00
2220	903.27T	3	95.00	3235GE(X)	A4.248 (Blue)	4	101.05
2230	1004.42	4	103.00	3235GE(X)	1004.42 (Green)	4	103.00
				3235SP(X)	A4.248 (Blue)	4	101.05
				3235SP(X)	1004.42 (Green)	4	103.00
				3315	903.27	3	95.00
				3315F/FE	903.27	3	95.00
				3315GE	903.27	3	95.00
				3315S	903.27	3	95.00

Part numbers are quoted for reference purposes only.
Our parts and accessories are not original.

Las referencias originales tienen un propósito identificativo.
Nuestras piezas no son originales.



TRACTOR AND ENGINE APPLICATION CHARTS
TRACTORES Y MOTORES, TABLA DE APLICACIONES

Tractors Tractores	Engine Motor	Cyl. Cil.	Bore mm Dia. mm	Tractors Tractores	Engine Motor	Cyl. Cil.	Bore mm Dia. mm
Series 3200 & 3300 Series				Series 4200 Series			
3315V	903.27	3	95.00	4265	1004.40TW	4	100.00
3325	903.27T	3	95.00	4270	1006.6 (Blue)	6	100.00
3325F/FE	903.27T	3	95.00	4270	1006.60T (Green)	6	100.00
3325GE	903.27T	3	95.00	Series 4300 Series			
3325S	903.27T	3	95.00	4315	903.27	3	95.00
3325V	903.27T	3	95.00	4320	903.27T	3	95.00
3330	1004.40	4	100.00	4325	1004.40	4	100.00
3330F/FE	1004.40	4	100.00	4325HV	1004.40	4	100.00
3330GE	1004.40	4	100.00	4335	1004.42	4	103.00
3330S	1004.40	4	100.00	4335HV	1004.42	4	103.00
3330V	1004.40	4	100.00	4345	1004.40T	4	100.00
3340	1004.42	4	103.00	4345HV	1004.40T	4	100.00
3340F/FE	1004.42	4	103.00	4355	1004.40T	4	100.00
3340GE	1004.42	4	103.00	4355HV	1004.40T	4	100.00
3340S	1004.42	4	103.00	4360	1006.60	6	100.00
3340V	1004.42	4	103.00	4365	1004.40TW	4	100.00
3350	1004.40T	4	100.00	4370	1006.60T	6	100.00
3350F/FE	1004.40T	4	100.00	Series 6100 Series			
3350GE	1004.40T	4	100.00	6110	A4.41	4	101.05
3350S	1004.40T	4	100.00	6120	A4.41	4	101.05
3355	1004.40T	4	100.00	6130	1004.4T	4	100.00
3355F/FE	1004.40T	4	100.00	6140	1004.4T	4	100.00
3355GE	1004.40T	4	100.00	6150	1004.4T	4	100.00
3355S	1004.40T	4	100.00	6160	1006.6	6	100.00
Series 3600 Series				6170	1006.6 (Blue)	6	100.00
3610	A6.354.4	6	98.48	6170	1006.60T (Green)	6	100.00
3630	AT6.354.4	6	98.48	6180	1006.6T (Blue)	6	100.00
3635	1006.6T	6	100.00	6180	1006.60T (Green)	6	100.00
3645	1006.6T	6	100.00	6190	1006.6T	6	100.00
3650	AT6.354.4	6	98.48	Series 6200 Series			
3655	1006.6T	6	100.00	6235	1004.40T	4	100.00
3660	1006.6T	6	100.00	6235HV	1004.40T	4	100.00
3670	620DS	6	108.00	6245	1004.40T	4	100.00
3680	612DS	6	108.00	6245HV	1004.40T	4	100.00
3690	612DS	6	108.00	6255	1004.40T	4	100.00
3690	634DS	6	108.00	6255HV	1004.40T	4	100.00
Series 4200 Series				6260	1006.60	6	100.00
4215	903.27	3	95.00	6265	1004.40TW	4	100.00
4220	903.27T	3	95.00	6270	1006.60T	6	100.00
4225	A4.41 (Blue)	4	101.05	6280	1006.60T	6	100.00
4225	1004.40 (Green)	4	100.00	6290	1006.60T	6	100.00
4225HV	A4.41 (Blue)	4	101.05	Series 8100 Series			
4225HV	1004.40 (Green)	4	100.00	8110	1006.6T	6	100.00
4235	A4.41 (Blue)	4	101.05	8120	1006.6T (Blue)	6	100.00
4235	1004.40T (Green)	4	100.00	8120	1006.60T (Green)	6	100.00
4235 (USA)	1004.42 (Green)	4	103.00	8130	1006.6T	6	100.00
4235HV	A4.41 (Blue)	4	101.05	8140	620DS	6	108.00
4235HV	1004.40T (Green)	4	100.00	8150	620DS	6	108.00
4235HV (USA)	1004.42 (Green)	4	103.00	8160	634DS	6	108.00
4240	A4.41	4	101.05	8170	645DSBIE	6	111.00
4245	1004.4T (Blue)	4	100.00	8180	645DSBIE	6	111.00
4245	1004.40T (Green)	4	100.00				
4245HV	1004.4T (Blue)	4	100.00				
4245HV	1004.40T (Green)	4	100.00				
4255	1004.4T (Blue)	4	100.00				
4255	1004.40T (Green)	4	100.00				
4255HV	1004.4T (Blue)	4	100.00				
4255HV	1004.40T (Green)	4	100.00				
4260	1006.6 (Blue)	6	100.00				
4260	1006.60 (Green)	6	100.00				

Part numbers are quoted for reference purposes only.
Our parts and accessories are not original.

Las referencias originales tienen un pequeño identificador.
Nuestras piezas no son originales.



TRACTOR AND ENGINE APPLICATION CHARTS
TRACTORES Y MOTORES, TABLA DE APLICACIONES

Tractors <i>Tractores</i>	Engine <i>Motor</i>	Cyl. <i>Cil.</i>	Bore mm <i>Dia. mm</i>	Tractors <i>Tractores</i>	Engine <i>Motor</i>	Cyl. <i>Cil.</i>	Bore mm <i>Dia. mm</i>
Series 8200 Series				Industrial tractors / Palas retrocargadoras			
8210	1006.60T	6	100.00	50C	A4.236	4	98.48
8220	1006.60T	6	100.00	50D	A4.236	4	98.48
8240	620DSRAE	6	108.00	50E	A4.236	4	98.48
8240XTRA	620DWBAE	6	108.00	50EX	A4.248	4	101.05
8250	634DSBAE	6	108.00	50H	A4.236	4	98.48
8250XTRA	634DWBAE	6	108.00	50H-S	A4.236	4	98.48
8260	634DSBAE	6	108.00	50H-T	A4.236	4	98.48
8260	634DSBIE	6	108.00	50HX	A4.248	4	101.05
8260XTRA	634DWBAE	6	108.00	50HX-S	A4.248	4	101.05
8270	645DSBIE	6	111.00	50HX-T	A4.248	4	101.05
8270XTRA	645DSBAE	6	111.00	60	A4.236	4	98.48
8280	645DSBIE	6	111.00	60H	A4.248	4	101.05
8280XTRA	645DSBAE	6	111.00	60H-S	A4.248	4	101.05
Telescopic handlers / Carretillas elevadoras telescópicas				60HX	AT4.236	4	98.48
24	A4.236	4	98.48	60HX-T	AT4.236	4	98.48
24T	AT4.236	4	98.48	70	A4.318	4	114.31
8925	1004.4 (Blue)	4	100.00	203	A3.152	3	91.49
8925	1004.42 (Green)	4	100.00	203	AD3.152	3	91.49
8925T	1004.4T (Blue)	4	100.00	205	A3.152	3	91.49
8925T	1004.40T (Green)	4	100.00	205	AD3.152	3	91.49
8926	1004.4 (Blue)	4	100.00	302	AD4.203	4	91.49
8926	1004.42 (Green)	4	100.00	304	AD4.203	4	91.49
8926T	1004.4T (Blue)	4	100.00	356	A4.203	4	91.49
8926T	1004.40T (Green)	4	100.00	356	AD4.203	4	91.49
8937	1004.4 (Blue)	4	100.00	702	23C	4	84.14
8937	1004.42 (Green)	4	100.00	2135	AD3.152	3	91.49
8937T	1004.4T (Blue)	4	100.00	2203	AD3.152	3	91.49
8937T	1004.40T (Green)	4	100.00	2205	AD3.152	3	91.49
8939	1004.4 (Blue)	4	100.00	3165	AD4.203	4	91.49
8939	1004.42 (Green)	4	100.00	3303	AD4.203	4	91.49
8939T	1004.4T (Blue)	4	100.00	3303	A4.212	4	98.48
8939T	1004.40T (Green)	4	100.00	3305	AD4.203	4	91.49
Industrial tractors / Palas retrocargadoras				3305	A4.212	4	98.48
MF Industrial / Palas retrocargadoras MF (⇒ 1992)				Farmac & Terax (1993 ⇒)			
20	AG3.152	3	91.49	750	1004.4 (Blue)	4	100.00
20	AD3.152	3	91.49	750	1004.42 (Green)	4	103.00
20B	AD3.152	3	91.49	750B	1004.42	4	103.00
20C	AD3.152	3	91.49	760	1004.4T (Blue)	4	100.00
20D	AD3.152	3	91.49	760	1004.40T (Green)	4	100.00
20E	AD3.152	3	91.49	760B	1004.40T	4	100.00
20F	AD3.152	3	91.49	860	1004.4T (Blue)	4	100.00
30	AD4.203	4	91.49	860	1004.40T (Green)	4	100.00
30B	AD3.152	3	91.49	860B	1004.40T	4	100.00
30D	A4.236	4	98.48	860S	1004.4T (Blue)	4	100.00
30E	AD3.152	3	91.49	860S	1004.40T (Green)	4	100.00
30H	AD3.152	3	91.49	860SE	1004.4T (Blue)	4	100.00
40	AG3.152	3	91.49	860SE	1004.40T (Green)	4	100.00
40	AD3.152	3	91.49	865	1004.4T	4	100.00
40B	AD4.203	4	91.49	960	1004.4T (Blue)	4	100.00
40E	AT3.152.4	3	91.49	960	1004.40T (Green)	4	100.00
50	AD4.203	4	91.49	960B	1004.40T	4	100.00
50	A4.212	4	98.48	965	1004.4T (Blue)	4	100.00
50	A4.236	4	98.48	965	1004.40T (Green)	4	100.00
50B	A4.212	4	98.48				
50B	A4.236	4	98.48				
50B Mk11	A4.236	4	98.48				

Part numbers are quoted for reference purposes only.
Our parts and accessories are not original.

Las referencias originales tienen un propósito identificativo.
Nuestras piezas no son originales.



TRACTOR AND ENGINE APPLICATION CHARTS
TRACTORES Y MOTORES, TABLA DE APLICACIONES

Tractors Tractores	Engine Motor	Cyl Cil.	Bore mm Dia. mm	Tractors Tractores	Engine Motor	Cyl Cil.	Bore mm Dia. mm
Combines / Cosechadoras				Combines / Cosechadoras			
8 Plot	A4.236	4	98.48	535	A6.354.4	6	98.48
10 Plot	A4.236	4	98.48	560	AT6.354.4	6	98.48
16 Plot	A4.236	4	98.48	565	AT6.354.4	6	98.48
16	A4.236	4	98.48	620	A6.372	6	101.05
20	A4.248	4	101.05	625	A6.372	6	101.05
20XP	AT4.236	4	98.48	660	AT6.354.4	6	98.48
24	A6.354.4	6	98.48	665	AT6.354.4	6	98.48
27	AT6.354.4	6	98.48	740	A6.372	6	101.05
29	AT6.354.4	6	98.48	750	A6.372	6	101.05
29XP	AT6.354.4	6	98.48	750	A6.372.4	6	101.05
31	AT6.354.4	6	98.48	750	AT6.354.1	6	98.48
31XP	AT6.354.4	6	98.48	750	AT6.354.4	6	98.48
99	A4.236	4	98.48	760	AT.6354.1	6	98.48
186	A4.212	4	98.48	760	AT6.354.4	6	98.48
187	A4.236	4	98.48	788	A4.270	4	107.95
206	A4.236	4	98.48	800	A6.354.4	6	98.48
240	A4.236	4	98.48	805	A6.354.4	6	98.48
307	A4.236	4	98.48	810	A6.354.4	6	98.48
330	A4.236	4	98.48	815	A6.354.4	6	98.48
400	A4.300	4	114.30	820	AT6.354.4	6	98.48
410	A4.300	4	114.30	825	AT6.354.4	6	98.48
415	A4.300	4	114.30	830	AT6.354.4	6	98.48
430	A4.248	4	101.05	835	AT6.354.4	6	98.48
440	A4.248	4	101.05	840	AT6.354.4	6	98.48
487	A4.248	4	101.05	845	AT6.354.4	6	98.48
500	A6.354	6	98.48	850	AT6.354.4	6	98.48
506	A4.248	4	101.05	855	AT6.354.4	6	98.48
507	A6.354	6	98.48	860	AT6.354.4	6	98.48
510	A6.354	6	98.48				
515	A6.354	6	98.48				
520	A6.354	6	98.48				
525	A6.354	6	98.48				
530	A6.354.4	6	98.48				
530S	A6.354.4	6	98.48				

Part numbers are quoted for reference purposes only.
Our parts and accessories are not original.

Las referencias originales tienen un propósito identificativo.
Nuestras piezas no son originales.



DERIVATIVE APPLICATION CHART (APPROPRIATE TO ENGINE PARTS)
TABLA PARA MODELOS DERIVADOS (USO SOBRE PIEZAS DE MOTOR)

Tractors <i>Tractores</i>	Engine <i>Motor</i>	Derivatives <i>Derivadas</i>	Tractors <i>Tractores</i>	Engine <i>Motor</i>	Derivatives <i>Derivadas</i>
3 cyl. Engines / Motores 3 cyl.			4 cyl. Engines / Motores 4 cyl.		
134	AD3.152	134C, 134V	384	A4.236	384AP, 384AP(X), 384AQ, 384F, 384FP, 384FP(X), 384FQ, 384GE, 384GE(X), 384S, 384SP, 384SP(X), 384SQ, 384V, 384VQ, 393LX, 393S
135	AD3.152	135V	393	A4.28	394AP, 394AP(X), 394AQ, 394C, 394F, 394FP, 394FP(X), 394FQ, 394GE, 394GE(X), 394H, 394S, 394SP, 394SP(X), 394SQ
145	AD3.152	145S, 145V	394	A4.248 (Blue)	394AP(X), 394FP(X), 394GE(X), 394SP(X)
152	AD3.152	152F, 152S, 152V	394	1004.42 (Green)	394AP(X), 394FP(X), 394GE(X), 394SP(X)
154	AD3.152	154C, 154F, 154S, 152V	396C	A4.248	396CF
164T	AT3.152.4	164TF, 164TS, 164TV	3220	A4.236 (Blue)	3220AP(X), 3220FP(X), 3220GE(X), 3220SP(X)
234	AD3.152	234C, 234CF, 234S	3220	1004.40 (Green)	3220AP(X), 3220FP(X), 3220GE(X), 3220SP(X)
254	AD3.152	254C, 254CF, 254S	3225	A4.236	3225AP(X), 3225FP(X), 3225GE(X), 3225SP(X)
264T	AT3.152.4	264TCF, 264TS	3235	A4.248 (Blue)	3235AP(X), 3235FP(X), 3235GE(X), 3235SP(X)
353	AD3.152	353LX, 353S	3235	1004.42 (Green)	3235AP(X), 3235FP(X), 3235GE(X), 3235SP(X)
354	AD3.152	354AP, 354AQ, 354F, 354FP, 354FP(X), 354FQ, 354GE, 354GE(X), 354S, 354SP, 354SP(X), 354SQ, 354V, 354VQ	3330	1004.40	3330F/FE, 3330GE, 3330S, 3330V
363	AT3.152.4	363LX, 363S	3340	1004.42	3340F/FE, 3340GE, 3340S, 3340V
364	AT3.152.4	364AP, 364AQ, 364CF, 364F, 364FP, 364FQ, 364GE, 364S, 364SP, 364SQ, 364V, 364VQ	3350	1004.40T	3350F/FE, 3350GE, 3350S
3210	AD3.152	3210FP(X), 3210GE(X), 3210SP(X)	3355	1004.40T	3355F/FE, 3350GE, 3355S
3315	903.27	3315F/FE, 3315GE, 3315S, 3315V	4225	A4.41 (Blue)	4225HV
3325	903.27T	3325F/FE, 3325GE, 3325S, 3325V	4225	1004.40 (Green)	4225HV
4 cyl. Engines / Motores 4 cyl.			4235	A4.41 (Blue)	4235HV
158 MKIII	AD4.203	158F, 158S, 158V	4235	1004.40 (Green)	4235HV
168 MKIII	A4.236	168F, 168S	4235 (USA)	1004.42 (Green)	4235HV (USA)
174	A4.212	174C	4245	1004.4T (Blue)	4245HV
174	A4.236	174C, 174F, 174S, 174V	4245	1004.40T (Green)	4245HV
175	A4.236	175S	4255	1004.4T (Blue)	4255HV
184	A4.236	184F, 194S	4255	1004.40T (Green)	4255HV
194	A4.248	194C, 194F, 194S	4325	1004.40	4325HV
274	A4.236	274C, 274CF, 274S, 274SK	4335	1004.42	4335HV
284	A4.236	284S	4345	1004.40T	4345HV
294	A4.248	294C, 294S	4355	1004.40T	4355HV
373	A4.236	373LX, 373S	6235	1004.40T	6235HV
374	A4.236 (Blue)	374AP, 374AP(X), 374AQ, 374F, 374FP, 374FP(X), 374FQ, 374GE, 374GE(X), 374H, 374S, 374SP, 374SP(X), 374SQ, 374V, 374VQ	6245	1004.40T	6245HV
374	1004.40 (Green)	374AP(X), 374FP(X), 374GE(X), 374SP(X)	6255	1004.40T	6255HV
376C	A4.236	376CF, 376XCF			
383	A4.236	383LX, 383S			

Derivative list is only appropriate to the engine parts section
La lista de derivados es únicamente aplicable a las piezas de motor

Part numbers are quoted for reference purposes only.
Our parts and accessories are not original.

Las referencias originales tienen un propósito identificativo.
Nuestras piezas no son originales.



LANDINI APPLICATION CHARTS
TABLA DE CORRESPONDENCIAS LANDINI

Landini Landini	MF MF	Engine Motor	Cyl. Cil.	Boring Dia.	Landini Landini	MF MF	Engine Motor	Cyl. Cil.	Boring Dia.
50 Blizzard	353LX	AD3.152	3	91.49	C5830	254C	AD3.152	3	91.49
55 F	354FQ	AD3.152	3	91.49	CF5830	254CF	AD3.152	3	91.49
55 FP	354FP	AD3.152	3	91.49	5840	254	AD3.152	3	91.49
55 GE	354GE	AD3.152	3	91.49	5860	353	AD3.152	3	91.49
55 GT	354AQ	AD3.152	3	91.49	5870	353S	AD3.152	3	91.49
55 GTP	354AP	AD3.152	3	91.49	6030	263T	AT3.152.4	3	91.49
55 L	354SQ	AD3.152	3	91.49	6030F	164TF	AT3.152.4	3	91.49
55 LP	354SP	AD3.152	3	91.49	6030L	164TS	AT3.152.4	3	91.49
55 V	354VQ	AD3.152	3	91.49	6030V	164TV	AT3.152.4	3	91.49
CF 55	356CF	AD3.152	3	91.49	CF6030	264TCF	AT3.152.4	3	91.49
60 Blizzard	363LX	AT3.152.4	3	91.49	6040	264T	AT3.152.4	3	91.49
60 F	364FQ	AT3.152.4	3	91.49	6060	363	AT3.152.4	3	91.49
60 FP	364FP	AT3.152.4	3	91.49	6060F	364F	AT3.152.4	3	91.49
60 GE	364GE	AT3.152.4	3	91.49	6060L	364S	AT3.152.4	3	91.49
60 GT	364AQ	AT3.152.4	3	91.49	6060V	364V	AT3.152.4	3	91.49
60 GTP	364AP	AT3.152.4	3	91.49	6070	363S	AT3.152.4	3	91.49
60 L	364SQ	AT3.152.4	3	91.49	6500	174	A4.236	4	98.48
60 LP	364SP	AT3.152.4	3	91.49	C6500	174C	A4.236	4	98.48
60 V	364VQ	AT3.152.4	3	91.49	6530F	174F	A4.236	4	98.48
CF 60	364CF	AT3.152.4	3	91.49	6530L	174S	A4.236	4	98.48
65 Blizzard	373LX	A4.236	4	98.48	6530V	174V	A4.236	4	98.48
65 F	374FQ	A4.236	4	98.48	6550	274SK	A4.236	4	98.48
65 FP	374FP	A4.236	4	98.48	6560F	374F	A4.236	4	98.48
65 GE	374GE	A4.236	4	98.48	6560L	374S	A4.236	4	98.48
65 GT	374AQ	A4.236	4	98.48	6560V	374V	A4.236	4	98.48
65 GTP	374AP	A4.236	4	98.48	6830	273	A4.236	4	98.48
65 L	374SQ	A4.236	4	98.48	C6830	274C	A4.236	4	98.48
65 LP	374SP	A4.236	4	98.48	CF6830	274CF	A4.236	4	98.48
65 V	374VQ	A4.236	4	98.48	6840	274	A4.236	4	98.48
75 Blizzard	383LX	A4.236	4	98.48	6860	373	A4.236	4	98.48
75 F	384FQ	A4.236	4	98.48	6870	373S	A4.236	4	98.48
75 FP	384FP	A4.236	4	98.48	6880	377	A4.236	4	98.48
75 GE	384GE	A4.236	4	98.48	7500	184	A4.236	4	98.48
75 GT	384AQ	A4.236	4	98.48	7530F	184F	A4.236	4	98.48
75 GTP	384AP	A4.236	4	98.48	7530L	184S	A4.236	4	98.48
75 L	384SQ	A4.236	4	98.48	7550	284S	A4.236	4	98.48
75 LP	384SP	A4.236	4	98.48	7560F	384F	A4.236	4	98.48
75 V	384VQ	A4.236	4	98.48	7560L	384S	A4.236	4	98.48
C 75	376C	A4.236	4	98.48	7560V	384V	A4.236	4	98.48
CF 75	376CF	A4.236	4	98.48	C7800	194C	A4.248	4	101.05
85 Blizzard	393LX	A4.248	4	101.05	7830	283	A4.236	4	98.48
85 F	394FQ	A4.248	4	101.05	C7830	294C	A4.248	4	101.05
85 FP	394FP	A4.248	4	101.05	7860	383	A4.236	4	98.48
85 GE	394GE	A4.248	4	101.05	7870	383S	A4.236	4	98.48
85 GT	394AQ	A4.248	4	101.05	7880	387	A4.236	4	98.48
85 GTP	394AP	A4.248	4	101.05	8500	194	A4.248	4	101.05
85 L	394SQ	A4.248	4	101.05	8500	294	A4.248	4	101.05
85 LP	394SP	A4.248	4	101.05	8530F	194F	A4.248	4	101.05
C 85	396C	A4.248	4	101.05	8530L	194S	A4.248	4	101.05
CF 85	396CF	A4.248	4	101.05	8550	294S	A4.248	4	101.05
95 GT	394TAQ	AT4.236	4	98.48	8560F	394F	A4.248	4	101.05
C 95	396CT	AT4.236	4	98.48	8560L	394S	A4.248	4	101.05
C4500	134C	AD3.152	3	91.49	8830	293	A4.248	4	101.05
4530V	134V	AD3.152	3	91.49	8860	393	A4.248	4	101.05
4560V	334V	AD3.152	3	91.49	C8860	394C	A4.248	4	101.05
C4830	234C	AD3.152	3	91.49	8880	397	A4.248	4	101.05
CF4830	234CF	AD3.152	3	91.49	9080	397T	AT4.236	4	98.48
CF5030	244CF	AD3.152	3	91.49	9500	1104	A6.354.1	6	98.48
5500	154	AD3.152	3	91.49	9880	1007	AT4.236	4	98.48
C5500	154C	AD3.152	3	91.49	10000	1014	A6.354.1	6	98.48
5530F	154F	AD3.152	3	91.49	10000S	1014	A6.354.4	6	98.48
5530L	154S	AD3.152	3	91.49	12500	1114	A6.354.4	6	98.48
5530V	154V	AD3.152	3	91.49	13000	1024	A6.354.4	6	98.48
5560F	354F	AD3.152	3	91.49	14500	1134	AT6.354.4	6	98.48
5560L	354S	AD3.152	3	91.49	16000	2720	AT6.354.4	6	98.48
5560V	354V	AD3.152	3	91.49	16500	2725	AT6.354.4	6	98.48
5830	253	AD3.152	3	91.49					

Part numbers are quoted for reference purposes only.
Our parts and accessories are not original.

Las referencias originales tienen un pequeño identificador.
Nuestras piezas no son originales.



CRANKSHAFT & RELATED PARTS
CIGÜEÑALES Y PIEZAS RELACIONADAS

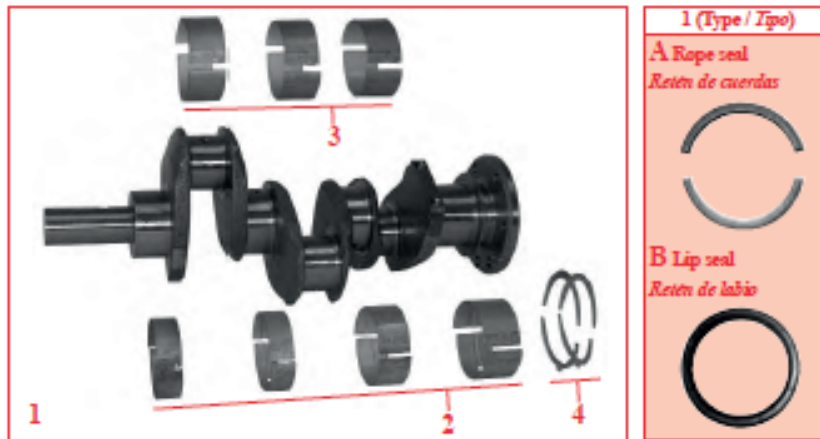

		1		2	3	4	
Tractors <i>Tractores</i>	Engine <i>Motor</i>	Crankshaft kit <i>Conjunto de cigüeñal</i>		Main bear. set <i>Juego cojinetes de bancada</i>	Conrod bear. set <i>Juego cojinetes de biela</i>	Thrust washer kit <i>Juego de arandelas axiales</i>	
3 cylinder engines / Motores 3 cilindros							
35, 133, 135	A3.144	Type / Tipo A 30/1-1 (ZZ90148, 4222037M91)	Type / Tipo B 30/1-5 (ZZ90150, 3641858M91)	30/2-1 (68084, 746156M91)	30/3-1 (85036, 737070M91)	30/6-1 (Std / Estándar) (U5TW0003)	
35	A3.152						
133, 134, 135, 140, 145, 148, 150, 152, 154, 233, 253 (Italy), 254	AD3.152						
135	AG3.152						
230, 234, 235, 240, 244CF, 245, 250, 255, 333, 334V, 340, 342, 350, 353, 354, 356CF, 550, 2205, 3210	AD3.152	30/1-5 (ZZ90150, 3641858M91)					
164T, 253 (UK), 263T (Italy), 264T, 352, 355 360 (CN31187)	AT3.152.4	30/1-26 (ZZ90151, 3641825M91)					
360 (CN31185), 363, 364, 366CF	AT3.152.4			30/2-76 (U5MB0008, 3637501M91)	30/3-76 (U5ME0005, 3637509M91)		30/6-2 (+ 0.19mm) (U5TW0003B)
2210	903.27				30/3-1 (85036, 737070M91)		
3315, 4215, 4315		30/1-77 (ZZ90179, 4223807M91)		30/2-77 (U5MB0014, 4222571M91)			
263 (UK), 2220, 3325, 4220, 4320	903.27T	30/1-78 (ZZ90183, 4222721M91)			30/3-76 (U5ME0005, 3637509M91)		

Main and conrod bearing sets are available in 0.010"- 0.020"- 0.030" undersize. Please add the suffix A, B, or C respectively.
0.040"- 0.050"- 0.060" on request.

Cojinetes de bancada y de biela disponibles en las siguientes sobremedidas 0.010"- 0.020"- 0.030". Ajustar los prefijos A, B, o C.
0.040"- 0.050"- 0.060" sobre pedido.

Top and bottom thrust washers are available separately. See page MF-19.
Juego de arandelas disponibles individualmente. Ver página MF-19.

Type / Tipo A : Rope seal / Retén de cuerdas
Type / Tipo B : Lip seal / Retén de labio

Part numbers are quoted for reference purposes only.
Our parts and accessories are not original.

Las referencias originales tienen un propósito identificativo.
Nuestras piezas no son originales.



CRANKSHAFT & RELATED PARTS
CIGÜENALES Y PIEZAS RELACIONADAS

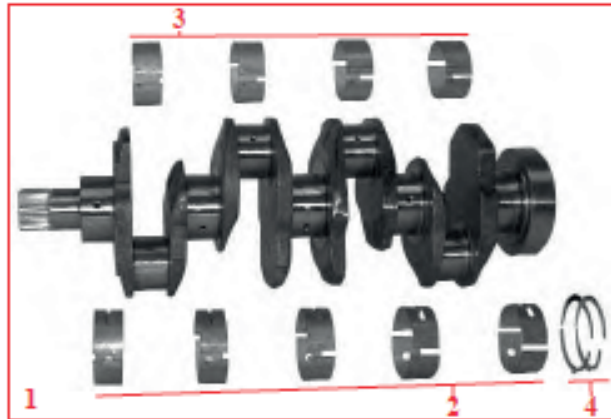

1 (Type / Tipo)

A Rope seal
Retén de cuerdas



B Lip seal
Retén de labio



		1		2	3	4
Tractors <i>Tractores</i>	Engine <i>Motor</i>	Crankshaft kit <i>Conjunto de cigüeñal</i>		Main bear. set <i>Juego cojinetes de bancada</i>	Conrod bear. set <i>Juego cojinetes de biela</i>	Thrust washer kit <i>Juego de arandelas axiales</i>
4 cylinder engines / Motores 4 cilindros						
TEA20 TED20 TEH20 35, 135	85mm Petrol 85mm VO 85mm LO 87mm Petrol			30/2-18 (554320M91)	30/3-18 (1810083M91)	30/6-13 (B613)
TEF20	20C Diesel			30/2-20 (830897M91)	30/3-19 (894923M91)	
FE35, 835	23C Diesel				30/3-20 (830899M91)	
25, 122 25, 30, 130, 825	A4.99 A4.107			30/2-10 (84992, 737239M91)	30/3-10 (85037, 736915M91)	
65 65, 865 65, 155, 158, 165, 765	A4.192 A4.203 AD4.203	Type / Tipo A 30/1-2 (ZZ90121, 3638473M91)	Type / Tipo B 30/1-34 (ZZ90111, 3637458M91)	30/2-2 (68082, 745405M91)	30/3-2 (85035, 737066M91)	30/6-1 (Std / Estándar) (U5TW0003)
158MKIII, 260, 560	AD4.203	30/1-34 (ZZ90111, 3637458M91)				30/6-2 (+ 0.19mm) (U5TW0003B)
165, 174	A4.212			30/2-3 (81558, 735168M91)	30/3-3 (85042, 736950M91)	30/6-3 (Std / Estándar) (U5TW0002)
168, 174, 175, 184, 255 (USA), 178, 185, 188, 194	A4.236 A4.248	Type / Tipo A 30/1-4 (ZZ90093, 3639541M1)	Type / Tipo B 30/1-7 (ZZ90081, 3637401M91)			30/6-4 (+ 0.19mm) (U5TW0002B)

Main and conrod bearing sets are available in 0.010"- 0.020"- 0.030" undersize. Please add the suffix A, B, or C respectively.
0.040"- 0.050"- 0.060" on request.

Cojinetes de bancada y de biela disponibles en las siguientes sobremedidas 0.010"- 0.020"- 0.030". Ajustar los prefijos A, B, o C.
0.040"- 0.050"- 0.060" sobre pedido.

Top and bottom thrust washers are available separately. See page MF-19.
Juego de arandelas disponibles individualmente. Ver página MF-19.

Type / Tipo A : Rope seal / Retén de cuerdas
Type / Tipo B : Lip seal / Retén de labio

Part numbers are quoted for reference purposes only.
Our parts and accessories are not original.

Las referencias originales tienen un prefijo identificativo.
Nuestras piezas no son originales.



CRANKSHAFT & RELATED PARTS
CIGÜEÑALES Y PIEZAS RELACIONADAS

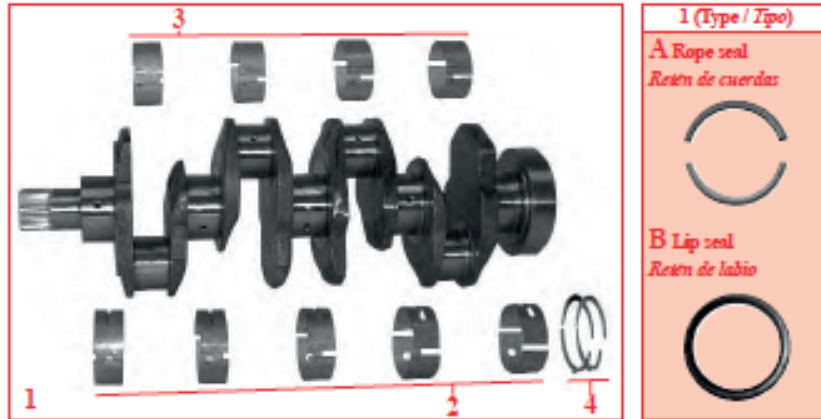

		1	2	3	4
Tractors Tractores	Engine Motor	Crankshaft kit Conjunto de cigüeñal	Main bear. set Juego cojinetes de bancada	Conrod bear. set Juego cojinetes de biela	Thrust washer kit Juego de arandelas aciales
4 cylinder engines / Motores 4 cilindros					
168MKIII, 265, 275, 565, 575 273, 274 (LD22573, LD22813) 283, 284 (LD22574, LD22756) 675 (LD31096, LD31097)		30/1-8 (C) (ZZ90082, 3637402M91)			
273, 274 (LD31174, LD31175) 283, 284 (LD31172, LD31173) 275E, 362, 362N, 365, 367CF, 372N, 373, 374, 375, 375E, 376C, 377, 383, 384, 387 675 (LD31110) 3050, 3220, 3225	A4-236	30/1-7 (C) (ZZ90081, 3637401M91)	30/2-3 (81558, 735168M91)	30/3-3 (85042, 736950M91)	30/6-3 (Std / Estándar) (USTW0002)
390T, 393TLX, 394TAQ, 396CT, 397T, 398, 698T, 1004T, 1007, 3065, 3065S, 3070	AT4-236	30/1-8 (C) (ZZ90082, 3637402M91)			30/6-4 (+ 0.19mm) (USTW0002B)
285, 290, 290E, 382N, 390, 390E, 590, 690, 3055, 3060 293, 294 (LF22575, LF22762)	A4-248	30/1-7 (C) (ZZ90081, 3637401M91)			
293, 294 (LF31176, LF31177) 393, 394, 396C, 397, 3235					
285 (USA), 592, 595, 1080, 1085	A4-318		30/2-11 (68085, 745584M91)	30/3-11 (85041, 736878M91)	
285 (USA), 298, 592, 595, 698, 1004	A4.318.2				

(C) Check which crankshaft is required as it is dependent on the engine build list. 30/1-8 has balancer weights incorporated in the web of the crankshaft whereas 30/1-7 has not.

(C) Comprobar el cigüeñal adecuado según el número de fabricación del motor. El cigüeñal 30/1-8 incluye contrapesos, el 30/1-7 no los tiene.

Main and conrod bearing sets are available in 0.010"-0.020"-0.030" under-size. Please add the suffix A, B, or C respectively: 0.040"-0.050"-0.060" on request.

Cojinetes de bancada y de biela disponibles en las siguientes sobremedidas 0.010"-0.020"-0.030". Ajustar los prefijos A, B, o C. 0.040"-0.050"-0.060" sobre pedido.

Top and bottom thrust washers are available separately. See page MF-19.
Juego de arandelas disponibles individualmente. Ver página MF-19.

Part numbers are quoted for reference purposes only.
Our parts and accessories are not original.

Las referencias originales tienen un propósito identificativo.
Nuestras piezas no son originales.



CRANKSHAFT & RELATED PARTS
CIGÜENALES Y PIEZAS RELACIONADAS

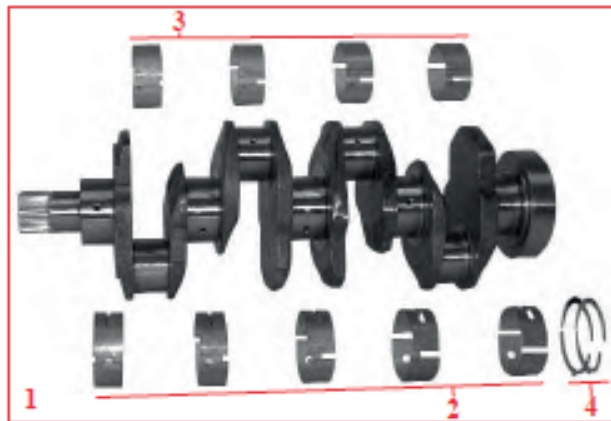

		1	2	3	4
Tractors <i>Tractores</i>	Engine <i>Motor</i>	Crankshaft kit <i>Conjunto de cigüeñal</i>	Main bear. set <i>Juego cojinetes de bancada</i>	Control bear. set <i>Juego cojinetes de biela</i>	Thrust washer kit <i>Juego de arandelas axiales</i>
4 cylinder engines / Motores 4 cilindros					
275E, 290E, 375E, 390E, 6110, 6120	A4.41 (Blue)	30/1-73 (ZZ90143, 3641031M91)	30/2-3 (81558, 735168M91)	30/3-3 (85042, 736950M91)	30/6-3 (Std / Estándar) (U5TW0002)
4225, 4235, 4240		30/1-7 (ZZ90081, 3637401M91)		30/3-28 (U5ME0006, 3637791M91)	
374, 3220	1004.40 (Green)	30/1-42 (ZZ90202, 4223939M91)		30/3-3 (85042, 736950M91)	
3330, 4225, 4325	1004.42 (Green)	30/1-73 (ZZ90143, 3641031M91)		30/3-28 (U5ME0006, 3637791M91)	
394, 2230, 3235, 4235 (USA), 4335		30/1-42 (ZZ90202, 4223939M91)		30/3-3 (85042, 736950M91)	
3340	1004.4T (Blue)	30/1-73 (ZZ90143, 3641031M91)		30/3-28 (U5ME0006, 3637791M91)	
3075, 4245, 4255, 6130, 6140, 6150		30/1-42 (ZZ90202, 4223939M91)		30/6-4 (+ 0.19mm) (U5TW0002B)	
3350, 3355, 4235, 4245, 4255, 4345, 4355, 6235, 6245, 6255	1004.40T (Green)				
4265, 4365, 6265	1004.40TW				

Main and control bearing sets are available in 0.010"- 0.020"- 0.030" undersizes. Please add the suffix A, B, or C respectively.
0.040"- 0.050"- 0.060" on request.

Cojinetes de bancada y de biela disponibles en las siguientes sobremedidas 0.010"- 0.020"- 0.030". Ajustar los prefijos A, B, o C.
0.040"- 0.050"- 0.060" sobre pedido.

Top and bottom thrust washers are available separately. See page MF-19.
Juego de arandelas disponibles individualmente. Ver página MF-19.

Part numbers are quoted for reference purposes only.
Our parts and accessories are not original.

Las referencias originales tienen un prefijo identificativo.
Nuestras piezas no son originales.



CRANKSHAFT & RELATED PARTS
CIGÜEÑALES Y PIEZAS RELACIONADAS

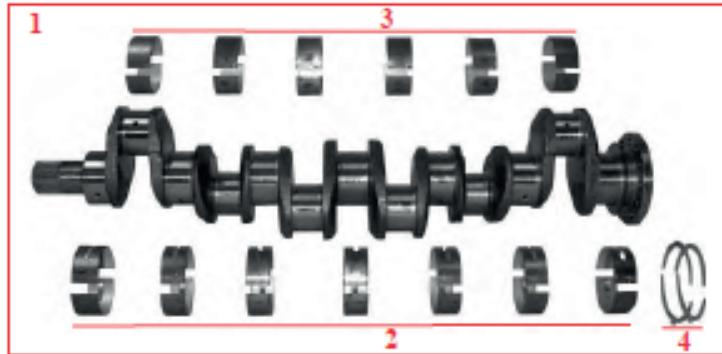

		1	2	3	4
Tractors <i>Tractores</i>	Engine <i>Motor</i>	Crankshaft kit <i>Conjunto de cigüeñal</i>	Main bear. set <i>Juego cojinetes de bancada</i>	Conrod bear. set <i>Juego cojinetes de biela</i>	Thrust washer kit <i>Juego de arandelas axiales</i>
6 cylinder engines / Motores 6 cilindros					
1100 1014, 1104	A6.354 A6.354.1		30/2-4 (85010, 736930M91)	30/3-4 (85043, 736934M91)	
1200	A6.354.1			30/3-29 (U5ME0003, 3637024M91)	
399, 699, 1014, 1024, 1114, 1250, 2620, 2625, 2640, 2645, 2675, 3080, 3090, 3610	A6.354.4	30/1-29 (D) (ZZ90196, 4224303M91)	30/2-29 (68079, 744921M91)	30/3-4 (85043, 736934M91)	
1105 1130 1135	ATC6.354.1 AT6.354 AT6.354.1		30/2-4 (U5MB0011, 4223140M91)		
1134, 2680, 2685, 2705, 2720, 2725, 3630, 3650	AT6.354.4	30/1-32 (D) (ZZ90165, 4224054M91)	30/2-29 (68079, 744921M91)	30/3-29 (U5ME0003, 3637024M91)	30/6-3 (Std / Estándar) (U5TW0002)
396, 399, 3085, 3095, 3115, 4260, 4270, 6160, 6170	1006.6 (Blue)			30/3-4 (85043, 736934M91)	30/6-4 (+ 0.19mm) (U5TW0002B)
3120, 3120T, 3125, 3140, 3635, 3645 3655, 3660 (YB31236, YB31247) 6180, 6190, 8110, 8120	1006.6T (Blue)	30/1-72 (ZZ90085, 3637019M91)	30/2-52 (U5MB0007, 3637020M91)		
4260, 4360	1006.60 (Green)				
4270, 4370, 6170, 6180, 6270, 6280, 6290, 8120, 8220	1006.60T (Green)			30/3-29 (U5ME0003, 3637024M91)	
3655, 3660 (YB31263) 8130	1006.6T (Blue)	30/1-32 (ZZ90165, 4224054M91)	30/2-45 (U5MB0010, 3640873M91)		
6260	1006.60				
8210	1006.60T				

Main and conrod bearing sets are available in 0.010"-0.020"-0.030" underlines. Please add the suffix A, B, or C respectively.
0.040"-0.050"-0.060" on request.

Cojinetes de bancada y de biela disponibles en las siguientes sobremedidas 0.010"-0.020"-0.030". Ajustar los prefijos A, B, o C.
0.040"-0.050"-0.060" sobre medida.

Top and bottom thrust washers are available separately. See page MF-19.
Juego de arandelas disponibles individualmente. Ver página MF-19.

(D) Use with crankshaft gear / Utilizar con el engranaje de cigüeñal 30/12-12 (31171682, 3637519M1)

Part numbers are quoted for reference purposes only.
Our parts and accessories are not original.

Las referencias originales tienen un propósito identificativo.
Nuestras piezas no son originales.



CRANKSHAFT & RELATED PARTS CIGÜENALES Y PIEZAS RELACIONADAS

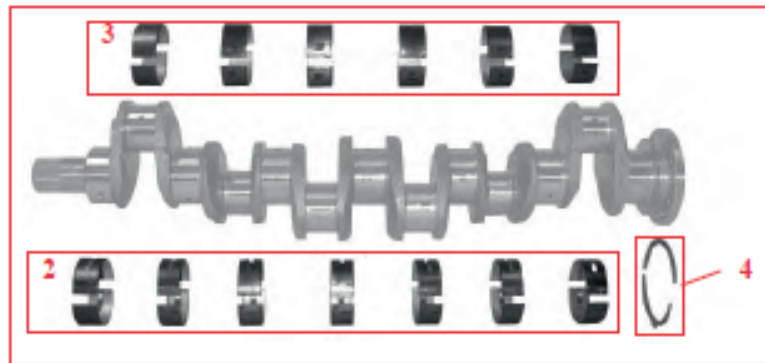

Tractors <i>Tractores</i>	Engine <i>Motor</i>	2 Main bear. set <i>Juego cojinetes de bancada</i>	3 Conrod bear. set <i>Juego cojinetes de biela</i>	4 Thrust washer kit <i>Juego de arandelas axiales</i>
6 cylinder engines / Motores 6 cilindros				
3680, 3690	612DS	30/2-48 (7x 3637631M91, 7x V836119457, 7x V836655514)	30/3-48 (6x V836110552)	1 of each 1 cada 30/6-30 (3637636M1, V836119459)
3670, 8140, 8150	620DS			
8240	620DSBAE			
8240Xtra	620DWBAE			
3690, 8160	634DS			
8250, 8260	634DSBAE			
8250Xtra, 8260Xtra	634DWBAE			
8260	634DSBIE			

Main and conrod bearing sets are available in 0.25mm - 0.50mm undersize. Please add the suffix A or B respectively.

Cojinetes de bancada y cojinetes de biela disponibles en las siguientes sobremedidas: 0.25mm- 0.50mm. Ajustar los prefijos A o B.

Part numbers are quoted for reference purposes only.
Our parts and accessories are not original.

*Las referencias originales tienen un propósito identificativo.
Nuestras piezas no son originales.*



CRANKSHAFT & RELATED PARTS
CIGÜENALES Y PIEZAS RELACIONADAS

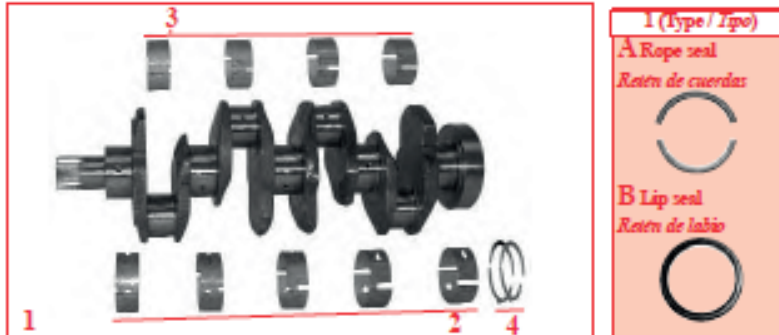

		1	2	3	4
Tractors <i>Tractores</i>	Engine <i>Motor</i>	Crankshaft kit <i>Conjunto de cigüeñal</i>	Main bear. set <i>Juego cojinetes de bancada</i>	Conrod bear. set <i>Juego cojinetes de biela</i>	Thrust washer kit <i>Juego de arandelas axiales</i>
4 cylinder engines combines / Cosechadoras motores 4 cilindros					
186	A4.212				
8Plot, 10Plot, 16Plot, 16, 330	A4.236	30/1-7 (ZZ90081, 3637401M91)			
20, 430	A4.248			30/3-3 (85042, 736950M91)	30/6-3 (Std / Estándar) (U5TW0002)
99, 187, 206, 240, 307	A4.236	Type / Tipo A 30/1-4 (ZZ90093, 3639541M1)	30/2-3 (81558, 735168M91)		30/6-4 (+ 0.19mm) (U5TW0002B)
440, 487, 506	A4.248	Type / Tipo B 30/1-8 (ZZ90082, 3637402M91)			
20XP	AT4.236			30/3-28 (U5ME0006, 3637791M91)	
788	A4.270				
400, 410, 415	A4.300		30/2-11 (68085, 745584M91)	30/3-11 (85041, 736878M91)	
6 cylinder engines combines / Cosechadoras motores 6 cilindros					
500, 507, 510, 515, 520, 525	A6.354		30/2-4 (85010, 736930M91)		
620, 625, 740, 750	A6.372			30/3-4 (85043, 736934M91)	30/6-3 (Std / Estándar) (U5TW0002)
24, 27, 530, 530S, 535, 800, 805, 810, 815	A6.354.4	30/1-29 (D) (ZZ90196, 4224303M91)	30/2-29 (68079, 744921M91)		
750	A6.372.4				
750, 760	AT6.354.1		30/2-4 (U5MB0011, 4223140M91)		30/6-4 (+ 0.19mm) (U5TW0002B)
29, 29XP, 31, 31XP, 560, 565, 660, 665, 750, 760, 820, 825, 830, 835, 840, 845, 850, 855, 860	AT6.354.4	30/1-32 (D) (ZZ90165, 4224054M91)	30/2-29 (68079, 744921M91)	30/3-29 (U5ME0003, 3637024M91)	
Telescopic handlers / Carretillas elevadoras telescópicas					
24	A4.236	30/1-7 (ZZ90081, 3637401M91)		30/3-3 (85042, 736950M91)	30/6-3 (Std / Estándar) (U5TW0002)
8925, 8926, 8937, 8939	1004.4 (Blue)				
8925, 8926, 8937, 8939	1004.42 (Green)		30/2-3 (81558, 735168M91)		
24T	AT4.236	30/1-42 (ZZ90202, 4223939M91)		30/3-28 (U5ME0006, 3637791M91)	30/6-4 (+ 0.19mm) (U5TW0002B)
8925T, 8926T, 8937T, 8939T	1004.4T (Blue)				
8925T, 8926T, 8937T, 8939T	1004.40T (Green)				

Main and conrod bearing sets are available in 0.010"-0.020"-0.030" under sizes. Please add the suffix A, B, or C respectively: 0.040"-0.050"-0.060" on request. *Cojinetes de bancada y de biela disponibles en las siguientes sobremedidas 0.010"-0.020"-0.030". Adjuntar los prefijos A, B, o C.*

Top and bottom thrust washers are available separately. See page MF-19. *Juego de arandelas disponibles individualmente. Ver página MF-19.*

(D) Use with crankshaft gear / Utilizar con el engranaje de cigüeñal 30/12-12 (31171682, 3637519M1)

Part numbers are quoted for reference purposes only.
Our parts and accessories are not original.

Las referencias originales tienen un propósito identificativo.
Nuestras piezas no son originales.



CRANKSHAFT & RELATED PARTS
CIGÜENALES Y PIEZAS RELACIONADAS

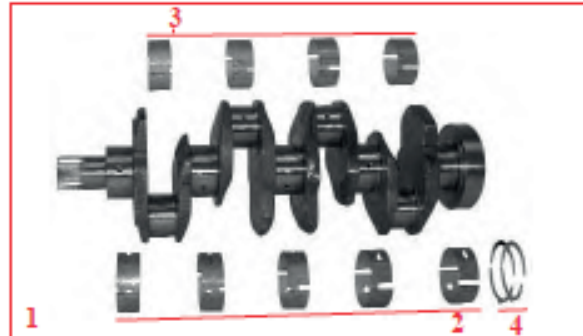

Tractors <i>Tractores</i>	Engine <i>Motor</i>	1 Crankshaft kit <i>Conjunto de cigüeñal</i>		2 Main bear. set <i>Juego cojinetes de bancada</i>	3 Counter bear. set <i>Juego cojinetes de biela</i>	4 Thrust washer kit <i>Juego de arandelas axiales</i>
3 cylinder engine industrial tractors / Palas retrocargadoras motores 3 cilindros						
203, 205 20, 40 20, 40, 203, 205, 2135, 2203, 2205	A3.152 AG3.152 AD3.152	Type / Tipo A 30/1-1 (ZZ90148, 4222037M91)	Type / Tipo B 30/1-5 (ZZ90150, 3641858M91)	30/2-1 (68084, 746156M91)	30/3-1 (85036, 737070M91)	30/6-1 (Std / Estándar) (U5TW0003)
20B, 20C, 20D, 20E, 20F, 30B, 30E, 30H	AD3.152	30/1-26 (ZZ90151, 3641825M91)				30/6-2 (+ 0.19mm) (U5TW0003B)
40E (CN31157, CN31158)	AT3.152.4			30/2-76 (U5MB0008, 3637501M91)	30/3-76 (U5ME0005, 3637509M91)	
40E (CN31195, CN31196)	AT3.152.4					
4 cylinder engine industrial tractors / Palas retrocargadoras motores 4 cilindros						
702	23C			30/2-20 (830897M91)	30/3-20 (830899M91)	
356 30, 40B, 50, 302, 304, 356, 3165, 3303, 3305	A4.203 AD4.203	Type A 30/1-2 (ZZ90121, 3638473M91)	Type B 30/1-34 (ZZ90111, 3637458M91)	30/2-2 (68082, 745405M91)	30/3-2 (85035, 737066M91)	30/6-1 (Std / Est.) (U5TW0003) 30/6-2 (+ 0.19mm) (U5TW0003B)
50, 50B, 3303, 3305	A4.212	30/1-8 (ZZ90082, 3637402M91)				
30D, 50D, 50E 50H (LD31134, LD31163), 60	A4.236	30/1-7 (ZZ90081, 3637401M91)		30/2-3 (81558, 735168M91)	30/3-3 (85042, 736950M91)	30/6-3 (Std / Estándar) (U5TW0002)
50, 50B, 50B MKII, 50C, 50H (LD31179), 50H-S, 50H-T	A4.236	30/1-8 (ZZ90082, 3637402M91)				
50EX, 50HX, 50HX-S, 50HX-T, 60H, 60H-S	A4.248					30/6-4 (+ 0.19mm) (U5TW0002B)
60HX, 60HX-T	AT4.236					
70	A4.318			30/2-11 (68085, 745584M91)	30/3-11 (85041, 736878M91)	
Ferrec & Terex - 4 cylinder engine industrial tractors / Palas retrocargadoras motores 4 cilindros						
750	1004.4 (Blue)	30/1-7 (ZZ90081, 3637401M91)			30/3-3 (85042, 736950M91)	30/6-3 (Std / Estándar) (U5TW0002)
750, 750B	1004.42 (Green)	30/1-8 (ZZ90082, 3637402M91)		30/2-3 (81558, 735168M91)	30/3-28 (U5ME0006, 3637791M91)	30/6-4 (+ 0.19mm) (U5TW0002B)
760, 860, 860S, 860SE, 865, 960, 965	1004.4T (Blue)					
760, 760B, 860, 860B, 860S, 860SE, 960, 960B, 965	1004.40T (Green)					

Main and counter bearing sets are available in 0.010"-0.020"-0.030" under size. Please add the suffix A, B, or C respectively: 0.040"-0.050"-0.060" on request.
Cojinetes de bancada y de biela disponibles en las siguientes sobremedidas 0.010"-0.020"-0.030". Ajustar los prefijos A, B, o C.
0.040"-0.050"-0.060" sobre pedido.

Top and bottom thrust washers are available separately. See page MF-19. / Juego de arandelas disponibles individualmente. Ver página MF-19.

Part numbers are quoted for reference purposes only.

Las referencias originales tienen un prefijo identificativo.

Our parts and accessories are not original.

Nuestras piezas no son originales.

CRANKSHAFT & RELATED PARTS
CIGÜEÑALES Y PIEZAS RELACIONADAS

Thrust washer kit contents / Composición juego de arandelas



Tractors <i>Tractores</i>	Size <i>Dimensiones</i>	Thrust washer kit <i>Juego de arandelas</i>	Contents / <i>Composición</i>	
			Top thrust washer <i>Arandela superior</i>	Bottom thrust washer <i>Arandela inferior</i>
			Quantity 2 / <i>Por 2</i>	
A3.144, A3.152, AD3.152, AG3.152, AT3.152.4 903.27, 903.27T A4.192, A4.203, AD4.203	Standard <i>Estándar</i>	30/6-1 (U5TW0003)	30/4-1 (31137211, 735112M1)	30/5-1 (31137221, 735113M1)
	+0.19mm <i>+0.007"</i>	30/6-2 (U5TW0003B)	30/4-2 (31137212, 735800M1)	30/5-2 (31137222, 735801M1)
A4.212, A4.236, AT4.236, A4.248, A4.318, A4.318.2, A4.41 1004.4, 1004.40, 1004.42, 1004.4T, 1004.40T A6.354, A6.354.1, A6.354.2, A6.354.4 AT6.354, AT6.354.1, ATC6.354.1, AT6.354.3, AT6.354.4 A6.372, A6.372.4 1006.6, 1006.60, 1006.6T, 1006.60T	Standard <i>Estándar</i>	30/6-3 (U5TW0002)	30/4-3 (31137551, 747128M1)	30/5-3 (31137561, 747129M1)
	+0.19mm <i>+0.007"</i>	30/6-4 (U5TW0002B)	30/4-4 (31137312, 735742M1)	30/5-4 (31137322, 735743M1)

Part numbers are quoted for reference purposes only.
Our parts and accessories are not original.

Las referencias originales tienen un propósito identificativo.
Nuestras piezas no son originales.



CRANKSHAFT & RELATED PARTS
CIGÜENALES Y PIEZAS RELACIONADAS



		1	2	3	4	5
Tractor Tractores	Engine Motor	Front cover seal Retén delantero	Crankshaft gear Piñón cigüeñal	Rear housing seal Retén trasero	Rear housing Carcasa trasera	Rear gasket Junta trasera
3 cylinder engines / Motores 3 cilindros						
35, 133, 135	A3.144			Rope seal Retén de cuencas 30/13-1 (36883119, 4224057M1)	Rope seal Retén de cuencas 30/14-1 (U5MK0401, 4224172M1)	Rope seal Retén de cuencas 30/17-1 (36817168, 4222068M1)
35	A3.152					
133, 134, 135, 140, 145, 148, 150, 152, 154, 233, 253 (Italy), 254	AD3.152			Lip seal Retén de labio 30/13-4 (C) (2418F475, 1447691M1)	Lip seal Retén de labio	Lip seal Retén de labio 30/17-4 (33826115, 3641894M1)
135	AG3.152	(A) 30/11-10 (2415344, 1447689M1)	30/12-10 (31163495, 3641826M1)			
230, 234, 235, 240, 244CF, 245, 250, 255, 333, 334V, 340, 342, 350, 353, 354, 356CF, 550, 2205, 3210	AD3.152					
164T, 253 (UK), 263T (Italy), 264T, 352, 355, 360, 363, 364, 366CF	AT3.152.4			30/13-4 (2418F475, 1447691M1)		30/17-4 (33826115, 3641894M1)
2210, 3315, 4215, 4315	903.27					
263 (UK), 2220, 3325, 4220, 4320	903.27T					

(A) Also available in the early leather seal 30/11-1 (2414111)
La versión antigua en cuero está disponible bajo la referencia 30/11-1 (2414111)

(C) Also available in the early red silicone seal 30/13-3 (2415391, 1447049M1)
La versión antigua en silicona roja está disponible bajo la referencia 30/13-3 (2415391, 1447049M1)

Part numbers are quoted for reference purposes only.
Our parts and accessories are not original.

Las referencias originales tienen un propósito identificativo.
Nuestras piezas no son originales.



CRANKSHAFT & RELATED PARTS
CIGÜEÑALES Y PIEZAS RELACIONADAS



Tractors Tractores	Engine Motor	1 Front cover seal Retén delantero	2 Crankshaft gear Piñón cigüeñal	3 Rear housing seal Retén trasero	4 Rear housing Carcasa trasera	5 Rear gasket Junta trasera
4 cylinder engines / Motores 4 cilindros						
TEA20 TED20 TEH20 35, 135	85mm Petrol 85mm VO 85mm LO 87mm Petrol	30/11-15 (825740M1)	30/12-17 (825136M1)	30/13-21 (825208M1)		
TEF20	20C Diesel			30/13-13 (1884098M1)		
FE35, 835	23C Diesel					
25, 122 25, 30, 130, 825	A4.99 A4.107	30/11-12 (0730098, 732043M1)		30/13-5 (36883115, 4224055M1)		
65 65, 865	A4.192 A4.203	51x70x13 30/11-21 (34157, 3639011M1)		Rope seal Retén de cojinetes 30/13-1 (36883119, 4224057M1)	Rope seal Retén de cojinetes 30/14-1 (U5MK0401, 4224172M1)	Rope seal Retén de cojinetes 30/17-1 (36817168, 4222068M1)
		57x76x9.5 30/11-10 (A) (2415344, 1447689M1)		Lip seal Retén de labio 30/13-4 (C) (2418F475, 1447691M1)	Lip seal Retén de labio	Lip seal Retén de labio 30/17-4 (33826115, 3641894M1)
65, 155, 158, 165, 765	AD4.203	30/11-10 (A) (2415344, 1447689M1)				Rope seal Retén de cojinetes 30/17-2 (36817174, 4223797M1)
158 MKIII, 260, 560	AD4.203			Lip seal Retén de labio 30/13-4 (C) (2418F475, 1447691M1)		Lip seal Retén de labio 30/17-4 (33826115, 3641894M1)

(A) Also available is the early leather seal 30/11-1 (2414111)
La versión antigua en cuero está disponible bajo la referencia 30/11-1 (2414111)

(C) Also available is the early red silicone seal 30/13-3 (2415391, 1447049M1)
La versión antigua en silicona roja está disponible bajo la referencia 30/13-3 (2415391, 1447049M1)

Part numbers are quoted for reference purposes only.
Our parts and accessories are not original.

Las referencias originales tienen un propósito identificativo.
Nuestras piezas no son originales.



CRANKSHAFT & RELATED PARTS
CIGÜENALES Y PIEZAS RELACIONADAS



		1	2	3	4	5
Tractors <i>Tractores</i>	Engine <i>Motor</i>	Front cover seal <i>Retén delantero</i>	Crankshaft gear <i>Piñón cigüeñal</i>	Rear housing seal <i>Retén trasero</i>	Rear housing <i>Carcasa trasera</i>	Rear gasket <i>Junta trasera</i>
4 cylinder engines / Motores 4 cilindros						
165, 174	A4.212			Rope seal <i>Resín de caeelas</i> 30/13-2 (36883116, 4224056M1)	Rope seal <i>Resín de caeelas</i> 30/14-3 (U5MK0404, 4224148M91)	Rope seal <i>Resín de caeelas</i> 30/17-3 (36817166, 3638780M1)
168, 174, 175, 184, 255 (USA)	A4.236			Lip seal <i>Retén de labio</i> 30/13-4 (C) (2418F475, 1447691M1)	Lip seal <i>Retén de labio</i>	Lip seal <i>Retén de labio</i> 30/17-5 (3681T018, 4223587M1)
178, 185, 188, 194	A4.248		30/12-3 (31171681, 734749M1)			
168MKIII, 265, 273, 274, 275, 275E, 283, 284, 367CF, 373, 374, 375E, 376C, 377, 383, 384, 387, 565, 575, 675, 3050, 3220, 3225	A4.236					
362, 362N, 365, 372N, 375 (⇨ U171963P)		30/11-11 (B) (2418F436, 1447690M1)				
362, 362N, 365, 372N, 375 (U171964P ⇨)	A4.236		30/12-11 31171683, 3638105M1)			
393TLX, 394TAQ, 396CT, 397T, 698T, 1004T, 1007, 3065, 3065S, 3070, 390T, 398 (⇨ U171963P)	AT4.236		30/12-3 (31171681, 734749M1)	30/13-4 (C) (2418F475, 1447691M1)		30/17-5 (3681T018, 4223587M1)
390T, 398 (U171964P ⇨)	AT4.236		30/12-11 31171683, 3638105M1)			
285, 290, 290E, 293, 294, 390E, 393, 394, 396C, 397, 590, 690, 3055, 3060, 3235 382N, 390 (⇨ U171963P)	A4.248		30/12-3 (31171681, 734749M1)			
382N, 390 (U171964P ⇨)	A4.248		30/12-11 31171683, 3638105M1)			

(B) Also available is the early nitrile seal 30/11-2 (32116, 3639007M1) and the red silicone seal 30/11-3 (2415361)
La versión antigua de nitrilo está disponible bajo la referencia 30/11-2 (32116, 3639007M1), también la versión de silicona roja 30/11-3 (2415361)

(C) Also available is the early red silicone seal 30/13-3 (2415391, 1447049M1)
La versión antigua en silicona roja está disponible bajo la referencia 30/13-3 (2415391, 1447049M1)

Part numbers are quoted for reference purposes only.
Our parts and accessories are not original.

*Las referencias originales tienen un pequeño identificador.
Nuestras piezas no son originales.*



CRANKSHAFT & RELATED PARTS
CIGÜEÑALES Y PIEZAS RELACIONADAS

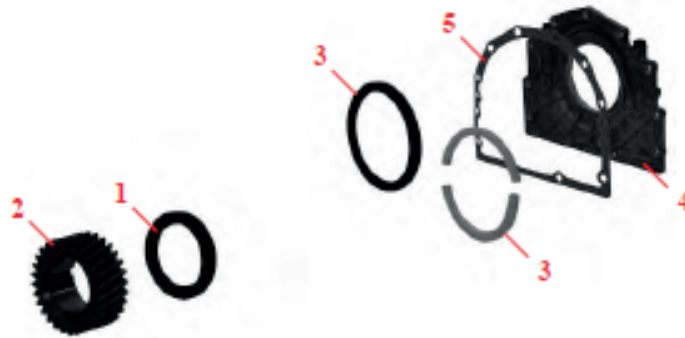

Tractors Tractores	Engine Motor	1 Front cover seal Retén delantero	2 Crankshaft gear Piñón cigüeñal	3 Rear housing seal Retén trasero	4 Rear housing Carcasa trasera	5 Rear gasket Junta trasera
4 cylinder engines / Motores 4 cilindros						
1080, 1085	A4.318	30/11-13 (2415346, 1447024M1)	30/12-16 (31165392, 734637M1)	Rope seal Retén de cojinetes 30/13-2 (36883116, 4224056M1) Lip seal Retén de labio 30/13-4 (C) (2418F475, 1447691M1)		Rope seal Retén de cojinetes 30/17-15 (21826321, 4223004M1) Lip seal Retén de labio 30/17-9 (21826316, 4223021M1)
285 (USA), 592, 595	A4.318					30/17-9 (21826316, 4223021M1)
285 (USA), 298, 592, 595, 698, 1004	A4.318.2					
275E, 290E, 375E, 390E	A4.41		30/12-11 (31171683, 3638105M1)			
4225, 4235, 4240, 6110, 6120	A4.41 (Blue)		30/12-3 (31171681, 734749M1)			
374, 3220, 3330	1004.40 (Green)		30/12-18 (3117C062, 4222820M1)			
4225, 4325	1004.40 (Green)		30/12-3 (31171681, 734749M1)	30/13-4 (2418F475, 1447691M1)		
394, 2230, 3235, 3340	1004.42 (Green)		30/12-18 (3117C062, 4222820M1)			
4235 (USA), 4335	1004.42 (Green)	30/11-11 (2418F436, 1447690M1)	30/12-3 (31171681, 734749M1)			30/17-5 (3681T018, 4223587M1)
3075, 6130, 6140, 6150	1004.4T		30/12-11 (31171683, 3638105M1)			
4245, 4255	1004.4T (Blue)		30/12-3 (31171681, 734749M1)			
3350, 3355	1004.40T		30/12-18 (3117C062, 4222820M1)			
4235, 4245, 4255, 4345, 4355, 6235, 6245, 6255	1004.40T (Green)					
4265, 4365, 6265	1004.40TW (Green)					

(C) Also available is the early red silicone seal 30/13-3 (2415391, 1447049M1)

La versión antigua en silicona roja está disponible bajo la referencia 30/13-3 (2415391, 1447049M1)

Part numbers are quoted for reference purposes only.

Our parts and accessories are not original.

Las referencias originales tienen un propósito identificativo.

Nuestras piezas no son originales.



CRANKSHAFT & RELATED PARTS
CIGÜENALES Y PIEZAS RELACIONADAS



		1	2	3	4	5
Tractors <i>Tractores</i>	Engine <i>Motor</i>	Front cover seal <i>Retén delantero</i>	Crankshaft gear <i>Pilón cigüeñal</i>	Rear housing seal <i>Retén trasero</i>	Rear housing <i>Carcasa trasera</i>	Rear gasket <i>Junta trasera</i>
6 cylinder engines / Motores 6 cilindros						
1100 1014, 1104, 1200	A6.354 A6.354.1	30/11-11 (B) (2418F436, 1447690M1)	30/12-4 (31171211, 733757M1)	Rope seal <i>Retén de cuerdas</i> 30/13-2 (36883116, 4224056M1)	Rope seal <i>Retén de cuerdas</i> 30/14-3 (U5MK0404, 4224148M91)	Rope seal <i>Retén de cuerdas</i> 30/17-3 (36817166, 3638780M1)
399, 699, 1014, 1114, 1250, 2620, 2625, 2640, 2645, 2675 <i>Crankshaft / Cigüeñal 68076</i>	A6.354.4			Lip seal <i>Retén de labio</i> 30/13-4 (C) (2418F475, 1447691M1)	Lip seal <i>Retén de labio</i>	Lip seal <i>Retén de labio</i> 30/17-5 (3681T018, 4223587M1)
399, 699, 1014, 1024, 1114, 1250, 2620, 2625, 2640, 2645, 2675, 3080, 3090, 3610 <i>Crankshaft / Cigüeñal</i> U5BG0037, ZZ90113, ZZ90196	A6.354.4		30/12-12 (31171682, 3637519M1)	30/13-4 (2418F475, 1447691M1)	30/17-5 (3681T018, 4223587M1)	
1105 1130 1135	AT6.354.1 AT6.354 AT6.354.1		30/12-4 (31171211, 733757M1)	Rope seal <i>Retén de cuerdas</i> 30/13-2 (36883116, 4224056M1)	Rope seal <i>Retén de cuerdas</i> 30/14-3 (U5MK0404, 4224148M91)	Rope seal <i>Retén de cuerdas</i> 30/17-3 (36817166, 3638780M1)
1134, 2680, 2685, 2705, 2720, 2725 <i>Crankshaft / Cigüeñal</i> 68055, 68077	AT6.354.4			Lip seal <i>Retén de labio</i> 30/13-4 (C) (2418F475, 1447691M1)	Lip seal <i>Retén de labio</i>	Lip seal <i>Retén de labio</i> 30/17-5 (3681T018, 4223587M1)
1134, 2680, 2685, 2705, 2720, 2725, 3630, 3650 <i>Crankshaft / Cigüeñal</i> U5BG0034, U5BG0035, ZZ90086, ZZ90105, ZZ90165	AT6.354.4			30/12-12 (31171682, 3637519M1)	30/13-4 (2418F475, 1447691M1)	30/17-5 (3681T018, 4223587M1)

(B) Also available is the early nitrile seal 30/11-2 (32116, 3639007M1) and the red silicone seal 30/11-3 (2415361)
La versión antigua de nitrilo está disponible bajo la referencia 30/11-2 (32116, 3639007M1), también la versión de silicona roja 30/11-3 (2415361)

(C) Also available is the early red silicone seal 30/13-3 (2415391, 1447049M1)
La versión antigua en silicona roja está disponible bajo la referencia 30/13-3 (2415391, 1447049M1)

Part numbers are quoted for reference purposes only.
Our parts and accessories are not original.

Las referencias originales tienen un pequeño identificativo.
Nuestras piezas no son originales.



CRANKSHAFT & RELATED PARTS
CIGÜEÑALES Y PIEZAS RELACIONADAS



		1	2	3	4	5
Tractors <i>Tractores</i>	Engine <i>Motor</i>	Front cover seal <i>Retén delantero</i>	Crankshaft gear <i>Pitón cigüeñal</i>	Rear housing seal <i>Retén trasero</i>	Rear housing <i>Carcasa trasera</i>	Rear gasket <i>Junta trasera</i>
Moteurs 6 cylindres / 6 cylinder engines						
396, 399, 3085, 3095, 3115, 4260, 4270, 6160, 6170	1006.6 (Blue)					
4260, 4360, 6260	1006.60 (Green)	30/11-11 (2418F436, 1447690M1)	30/12-15 (3117C061, 748201M1)	30/13-4 (2418F475, 1447691M1)		30/17-5 (3681T018, 4223587M1)
3120, 3120T, 3125, 3140, 3635, 3645, 3655, 3660, 6180, 6190, 8110, 8120, 8130	1006.6T (Blue)					
4270, 4370, 6170, 6180, 6270, 6280, 6290, 8120, 8210, 8220	1006.60T (Green)					
3680, 3690	612DS					
3670, 8140, 8150	620DS					
8240	620DSRAE					
8240Xtra	620D/WBAE	30/11-32 (V614105880, 3637617M1)		30/13-35 (V614400002, V614500002, 3637618M1)		
3690, 8160	634DS					
8250, 8260	634DSBAE					
8260	634DSBIE					
8250Xtra, 8260Xtra	634D/WBAE					
8170, 8180, 8270, 8280	645DSBIE	30/11-33 (V836840883)				

Part numbers are quoted for reference purposes only.
Our parts and accessories are not original.

Las referencias originales tienen un propósito identificativo.
Nuestras piezas no son originales.



CRANKSHAFT & RELATED PARTS
CIGÜEÑALES Y PIEZAS RELACIONADAS



Tractors <i>Tractores</i>	Engine <i>Motor</i>	1 Front cover seal <i>Retén delantero</i>	2 Crankshaft gear <i>Piñón cigüeñal</i>	3 Rear housing seal <i>Retén trasero</i>	4 Rear housing <i>Carcasa trasera</i>	5 Rear gasket <i>Junta trasera</i>
 4 cylinder engines combines / Cosechadoras motores 4 cilindros						
186	A4.212			Rope seal <i>Retén de cascos</i> 30/13-2 (36883116, 4224056M1)	Rope seal <i>Retén de cascos</i> 30/14-3 (USME0404, 4224148M91)	Rope seal <i>Retén de cascos</i> 30/17-3 (36817166, 3638780M1)
99, 187, 206, 307	A4.236	30/11-11 (B) (2418F436, 1447690M1)	30/12-3 (31171681, 734749M1)	Lip seal <i>Retén de labio</i> 30/13-4 (C) (2418F475, 1447691M1)	Lip seal <i>Retén de labio</i>	Lip seal <i>Retén de labio</i> 30/17-5 (3681T018, 4223587M1)
487, 506	A4.248					
8 Plot, 10 Plot, 16 Plot, 16, 240, 330	A4.236					
20, 430, 440	A4.248					
20XP	AT4.236					
788	A4.270	30/11-34 (34186, 3639012M1)		30/13-2 (36883116, 4224056M1)		
400, 410, 415	A4.300	30/11-13 (2415346, 1447024M1)	30/12-16 (31165392, 734637M1)			30/17-15 (21826321, 4223004M1)

(B) Also available is the early nitrile seal 30/11-2 (32116, 3639007M1) and the red silicone seal 30/11-3 (2415361)
La versión antigua de nitrilo está disponible bajo la referencia 30/11-2 (32116, 3639007M1), también la versión de silicona roja 30/11-3 (2415361)

(C) Also available is the early red silicone seal 30/13-3 (2415391, 1447049M1)
La versión antigua en silicona roja está disponible bajo la referencia 30/13-3 (2415391, 1447049M1)

Part numbers are quoted for reference purposes only.
Our parts and accessories are not original.

Las referencias originales tienen un propósito identificativo.
Nuestras piezas no son originales.



CRANKSHAFT & RELATED PARTS
CIGÜEÑALES Y PIEZAS RELACIONADAS



Tractors <i>Tractores</i>	Engine <i>Motor</i>	1 Front cover seal <i>Retén delantero</i>	2 Crankshaft gear <i>Piñón cigüeñal</i>	3 Rear housing seal <i>Retén trasero</i>	4 Rear housing <i>Carcasa trasera</i>	5 Rear gasket <i>Junta trasera</i>		
6 cylinder engines combines / Cosechadoras motores 6 cilindros								
500, 507, 510, 515, 520, 525	A6.354	30/11-11 (B) (2418F436, 1447690M1)	30/12-4 (31171211, 733757M1)	Rope seal <i>Resbi de cuerdas</i> 30/13-2 (36883116, 4224056M1)	Rope seal <i>Resbi de cuerdas</i> 30/14-3 (U5MK0404, 4224148M91)	Rope seal <i>Resbi de cuerdas</i> 30/17-3 (36817166, 3638780M1)		
620, 625, 740, 750	A6.372			Lip seal <i>Resbi de labio</i> 30/13-4 (C) (2418F475, 1447691M1)	Lip seal <i>Retén de labio</i>	Lip seal <i>Retén de labio</i> 30/17-5 (3681T018, 4223587M1)		
24, 27, 530, 530S, 535, 800, 805, 810, 815 <i>Crankshaft / Cigüeñal 68076</i>	A6.354.4		30/12-12 (31171682, 3637519M1)	30/13-4 (2418F475, 1447691M1)	30/17-5 (3681T018, 4223587M1)			
24, 27, 530, 530S, 535, 800, 805, 810, 815 <i>Crankshaft / Cigüeñal</i> U5BG0037, ZZ90113, ZZ90196	A6.354.4							
750	A6.372.4		30/12-4 (31171211, 733757M1)	Rope seal <i>Resbi de cuerdas</i> 30/13-2 (36883116, 4224056M1)	Rope seal <i>Resbi de cuerdas</i> 30/14-3 (U5MK0404, 4224148M91)	Rope seal <i>Resbi de cuerdas</i> 30/17-3 (36817166, 3638780M1)		
750, 760	AT6.354.1						Lip seal <i>Resbi de labio</i> 30/13-4 (C) (2418F475, 1447691M1)	Lip seal <i>Resbi de labio</i> 30/17-5 (3681T018, 4223587M1)
29, 29XP, 31, 31XP, 560, 565, 660, 665, 750, 760, 820, 825, 830, 835, 840, 845, 850, 855, 860 <i>Crankshaft / Cigüeñal</i> 68055, 68077	AT6.354.4						30/12-12 (31171682, 3637519M1)	30/13-4 (2418F475, 1447691M1)
29, 29XP, 31, 31XP, 560, 565, 660, 665, 750, 760, 820, 825, 830, 835, 840, 845, 850, 855, 860 <i>Crankshaft / Cigüeñal</i> U5BG0034, U5BG0035, ZZ90086, ZZ90105, ZZ90165	AT6.354.4							

(B) Also available is the early nitrile seal 30/11-2 (32116, 3639007M1) and the red silicone seal 30/11-3 (2415361)
La versión antigua de nitrilo está disponible bajo la referencia 30/11-2 (32116, 3639007M1), también la versión de silicona roja 30/11-3 (2415361)

(C) Also available is the early red silicone seal 30/13-3 (2415391, 1447049M1)
La versión antigua en silicona roja está disponible bajo la referencia 30/13-3 (2415391, 1447049M1)

Part numbers are quoted for reference purposes only.
Our parts and accessories are not original.

Las referencias originales tienen un propósito identificativo.
Nuestras piezas no son originales.



CRANKSHAFT & RELATED PARTS
CIGÜENALES Y PIEZAS RELACIONADAS



		1	2	3	4	5
Tractors <i>Tractores</i>	Engine <i>Motor</i>	Front cover seal <i>Retén delantero</i>	Crankshaft gear <i>Piñón cigüeñal</i>	Rear housing seal <i>Retén trasero</i>	Rear housing <i>Carcasa trasera</i>	Rear gasket <i>Junta trasera</i>
Telescopic handlers / Carretillas elevadoras telescópicas						
24	A4.236	30/11-11 (2418F436, 1447690M1)	30/12-3 (31171681, 734749M1)	30/13-4 (2418F475, 1447691M1)		30/17-5 (3681T018, 4223587M1)
24T	AT4.236					
8925, 8926, 8937, 8939	1004.4 (Blue)					
8925, 8926, 8937, 8939	1004.42 (Green)					
8925T, 8926T, 8937T, 8939T	1004.4T (Blue)					
8925T, 8926T, 8937T, 8939T	1004.40T (Green)					
3 cylinder engine industrial tractors / Palas retrocargadoras motores 3 cilindros						
203, 205	A3.152	(A) 30/11-10 (2415344, 1447689M1)	30/12-10 (31163495, 3641826M1)	Rope seal <i>Retén de caudex</i> 30/13-1 (36883119, 4224057M1)	Rope seal <i>Retén de caudex</i> 30/14-1 (U5MK0401, 4224172M1)	Rope seal <i>Retén de caudex</i> 30/17-1 (36817168, 4222068M1)
20, 40	AG3.152					
20, 40, 203, 205, 2135, 2203, 2205	AD3.152			Lip seal <i>Retén de labio</i> 30/13-4 (C) (2418F475, 1447691M1)	Lip seal <i>Retén de labio</i>	Lip seal <i>Retén de labio</i> 30/17-4 (33826115, 3641894M1)
20B, 20C, 20D, 20E, 20F, 30B, 30E, 30H	AD3.152			30/13-4 (2418F475, 1447691M1)		30/17-4 (33826115, 3641894M1)
40E	AT3.152.4					

(A) Also available is the early leather seal 30/11-1 (2414111)
La versión antigua en cuero está disponible bajo la referencia 30/11-1 (2414111)

(C) Also available is the early red silicone seal 30/13-3 (2415391, 1447049M1)
La versión antigua en silicona roja está disponible bajo la referencia 30/13-3 (2415391, 1447049M1)

Part numbers are quoted for reference purposes only.
Our parts and accessories are not original.

Las referencias originales tienen un propósito identificativo.
Nuestras piezas no son originales.



CRANKSHAFT & RELATED PARTS
CIGÜEÑALES Y PIEZAS RELACIONADAS



		1	2	3	4	5
Tractors Tractores	Engine Motor	Front cover seal Retén delantero	Crankshaft gear Piñón cigüeñal	Rear housing seal Retén trasero	Rear housing Carcasa trasera	Rear gasket Junta trasera
4 cylinder engine industrial tractors / Palas retrocargadoras motores 4 cilindros						
702	23C Diesel	30/11-15 (825740M1)		30/13-13 (1884096M1)		
356	A4.203	30/11-10 (A) (2415344, 1447689M1)		Rope seal Retén de cojinetes 30/13-1 (368831119, 4224057M1)	Rope seal Retén de cojinetes 30/14-1 (U5MK0401, 4224172M1)	Rope seal Retén de cojinetes 30/17-1 (36817168, 4222068M1)
30, 40B, 50, 302, 304, 356, 3165, 3303, 3305	AD4.203		Lip seal Retén de labio 30/13-4 (C) (2418F475, 1447691M1)	Lip seal Retén de labio 30/17-4 (33826115, 3641894M1)		Rope seal Retén de cojinetes 30/17-2 (36817174, 4223797M1)
50, 50B, 3303, 3305	A4.212	30/11-11 (B) (2418F436, 1447690M1)	30/12-3 (31171681, 734749M1)	Rope seal Retén de cojinetes 30/13-2 (36883116, 4224056M1)	Rope seal Retén de cojinetes 30/14-3 (U5MK0404, 4224148M91)	Rope seal Retén de cojinetes 30/17-3 (36817166, 3638780M1)
				Lip seal Retén de labio 30/13-4 (C) (2418F475, 1447691M1)	Lip seal Retén de labio	Lip seal Retén de labio 30/17-5 (36817018, 4223587M1)

- (A) Also available is the early leather seal 30/11-1 (2414111)
La versión antigua en cuero está disponible bajo la referencia 30/11-1 (2414111)
- (B) Also available is the early nitrile seal 30/11-2 (32116, 3639007M1) and the red silicone seal 30/11-3 (2415361)
La versión antigua de nitrilo está disponible bajo la referencia 30/11-2 (32116, 3639007M1), también la versión de sílicona roja 30/11-3 (2415361)
- (C) Also available is the early red silicone seal 30/13-3 (2415391, 1447049M1)
La versión antigua en sílicona roja está disponible bajo la referencia 30/13-3 (2415391, 1447049M1)

Part numbers are quoted for reference purposes only.
Our parts and accessories are not original.

Las referencias originales tienen un propósito identificativo.
Nuestras piezas no son originales.



CRANKSHAFT & RELATED PARTS
CIGÜEÑALES Y PIEZAS RELACIONADAS



		1	2	3	4	5
Tractors <i>Tractores</i>	Engine <i>Motor</i>	Front cover seal <i>Retén delantero</i>	Crankshaft gear <i>Pilón cigüeñal</i>	Rear housing seal <i>Retén trasero</i>	Rear housing <i>Carcasa trasera</i>	Rear gasket <i>Junta trasera</i>
4 cylinder engine industrial tractors / Palas retrocargadoras motores 4 cilindros						
30D, 50, 50B, 50B MKII, 50C, 50D, 50E, 50H, 50H-S, 50H-T, 60	A4.236	30/11-11 (2418F436, 1447690M1)	30/12-3 (31171681, 734749M1)	30/13-4 (2418F475, 1447691M1)		30/17-5 (3681T018, 4223587M1)
50EX, 50HX, 50HX-S, 50HX-T, 60H, 60H-S	A4.248					
60HX, 60HX-T	AT4.236					
70	A4.318	30/11-13 (2415346, 1447024M1)				30/17-9 (21826316, 4223021M1)
Ferrec & Terex - 4 cylinder engine industrial tractors / Palas retrocargadoras motores 4 cilindros						
750	1004.4 (Blue)	30/11-11 (2418F436, 1447690M1)	30/12-3 (31171681, 734749M1)	30/13-4 (2418F475, 1447691M1)		30/17-5 (3681T018, 4223587M1)
750, 750B	1004.42 (Green)					
760, 860, 860S, 860SE, 865, 960, 965	1004.4T (Blue)					
760, 760B	1004.40T (Green)					
860, 860B, 860S, 860SE, 960, 960B, 965	1004.40T (Green)					

Part numbers are quoted for reference purposes only.
Our parts and accessories are not original.

Las referencias originales tienen un propósito identificativo.
Nuestras piezas no son originales.



WEAR SLEEVE CASQUILLO DE DESGASTE

Series "200", "4200", "6200" series
Engines A4.236, A4.41, 1004, 1006 Motores

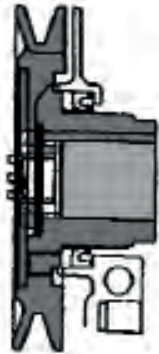

30/18-1
(21820104,
4222564M91)



30/18-1 is a wear sleeve service kit to recondition worn crankshaft pulleys on engines fitted with the latest timing case from the following serial numbers.

4.236 and 4.41 : U786357C ⇨

1004 : U802612C ⇨

1006 : U714848E ⇨

A new front seal 30/11-11 (2418F436, 1447690M1) must be fitted with the 30/18-1 wear sleeve

30/18-1 es un casquillo de desgaste para reacondicionar las poleas de cigüeñal en los motores con tapas de distribución de última versión desde los números de serie :

4.236 y 4.41 : U786357C ⇨

1004 : U802612C ⇨

1006 : U714848E ⇨

Un retén frontal nuevo 30/11-11 (2418F436, 1447690M1) debe ser montado con el casquillo de desgaste 30/18-1

CORE PLUGS TAPONES DEL BLOQUE



Mild steel core plugs Tapones de acero dulce				Stainless steel core plugs Tapones de acero inoxidable			
Ref. Ref.	Ø mm	Ø Inch Ø Pulgs.	OEM	Ref. Ref.	Ø mm	Ø Inch Ø Pulgs.	OEM
30/2410-1	Kit contains 8 of each mild steel core plug except 30/21-50 <i>La caja contiene 8 tapones de cada medida, excepto 30/21-50</i>						
30/21-17	17.6	0.69	0650566, 731356M1				
30/21-19	19.4	0.75					
30/21-22	22.6	0.88	0650664, 731999M1				
30/21-25	25.8	1.00	0650576, 3639193M1				
30/21-32	32.2	1.25	0650563, 735865M1	30/22-32	32.2	1.25	0650710, 731354M1
30/21-35	35.4	1.38	0650618, 376190X1	30/22-35	35.4	1.38	32418117, 735944M1
30/21-38	38.5	1.50	32416118, 4222012M1	30/22-38	38.5	1.50	32418122, 746259M1
30/21-50	50.2	1.97	32416119, 4222043M1				

Part numbers are quoted for reference purposes only.
Our parts and accessories are not original.

Las referencias originales tienen un propósito identificativo.
Nuestras piezas no son originales.



CONNECTING RODS & RELATED PARTS
BIELAS Y PIEZAS RELACIONADAS

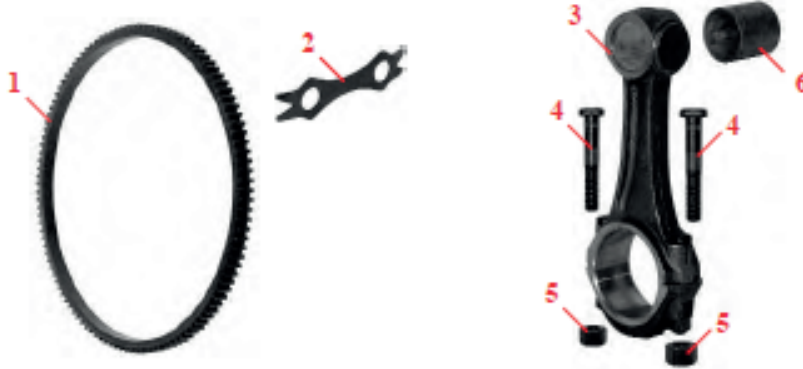

		1	2	3	4	5	6
Tractors Tractores	Engine Motor	Ring gear Corona de volante	Tab washer Chapa seguro	Conrod Biela	Conrod bolt Tornillo biela	Conrod nut Tuercas de biela	Small end bush Casquillo pie de biela
3 cylinder engines / Motores 3 cilindros							
35, 133, 135	A3.144			30/25-1 (ZZ90011, 3637439M91)			
35	A3.152						
135	AG3.152	30/15-1 (0410236, 731008M1, 3819719M1)	30/16-1 (0921062, 731192M1)	30/25-2 (ZZ90010, 3637392M91)			
133, 134, 135, 140, 145, 148, 150, 152, 154, 233, 234, 235, 240, 244CF, 245, 250, 253 (Italy), 254, 255, 333, 334V, 350	AD3.152						
353, 354 (⇒ 12/94)							
230, 340, 342, 350	AD3.152						
353, 354 (1/95 ⇒)	AD3.152						
356CF, 2205, 3210		30/15-13 (3552228M1)			30/26-1 (0095250, 375756X1)	30/27-1 (33221327, 1476245X1)	30/28-1 (31134151, 740407M1)
164T, 263T (Italy), 264T	AT3.152.4	30/15-1 (0410236, 731008M1, 3819719M1)	30/16-1 (0921062, 731192M1)				
253 (UK), 352, 355, 360	AT3.152.4						
363, 364 (⇒ 12/94)							
363, 364 (1/95 ⇒)	AT3.152.4						
366CF		30/15-13 (3552228M1, 0.011.9771.0)					
2210, 3315	903.27						
2220, 3325	903.27T						
4215, 4315	903.27	30/15-1 (0410236, 731008M1, 3819719M1)					
263 (UK), 4220, 4320	903.27T						

Part numbers are quoted for reference purposes only.
Our parts and accessories are not original.

Las referencias originales tienen un propósito identificativo.
Nuestras piezas no son originales.



CONNECTING RODS & RELATED PARTS
BIELAS Y PIEZAS RELACIONADAS

For the flywheel
assy. see
page 232
Para volante
del motor ver
pagina 232

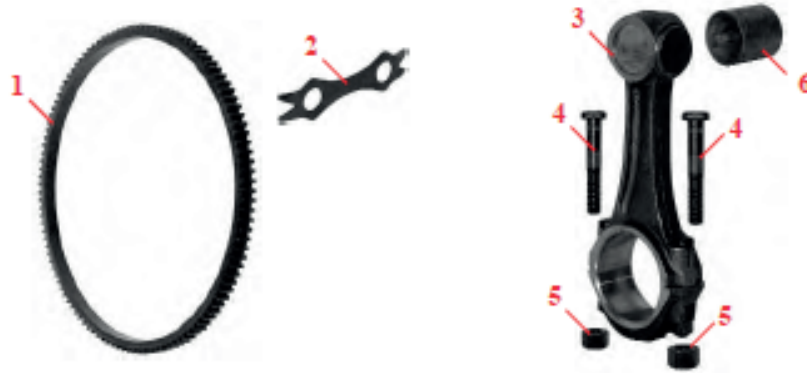

Tractors Tractores	Engine Motor	1 Ring gear Corona de volante	2 Tab washer Chapa seguro	3 Conrod Biela	4 Conrod bolt Tornillo biela	5 Conrod nut Tuerca de biela	6 Small end bush Casquillo pie de biela
4 cylinder engines / Motores 4 cilindros							
TEF20	20C Diesel	30/15-15 (826049M1)					
FE35, 835	23C Diesel						30/28-33 (1884944M1)
25, 122	20C Diesel						30/28-3 (31134146, 738339M1)
25, 30, 130, 825	23C Diesel						
65	A4.192			30/25-1 (ZZ90011, 3637439M91)	30/26-1 (0095250, 375756X1)	30/27-1 (33221327, 1476245X1)	30/28-1 (31134151, 740407M1)
65, 865	A4.203		30/16-1 (0921062, 731192M1)	30/25-2 (ZZ90010, 3637392M91)			
65, 155, 158, 158MKIII, 165, 260, 560, 765	AD4.203						
165, 174	A4.212	30/15-1 (0410236, 731008M1, 3819719M1)					
168, 174, 175, 184, 255 (USA), 265, 273, 274, 275, 283, 284, 565, 575	A4.236			30/25-3 (ZZ90009, 3637034M91)			30/28-2 (31134123, 733767M1)
168MKIII, 275E, 362, 362N, 365, 372N, 375, 375E, 675, 3050	A4.236						
373, 374, 383, 384 (⇨ 12/94)							
373, 374, 383, 384 (1/95 ⇨)							
367CF, 376C, 377, 387, 3220, 3225	A4.236	30/15-13 (3552228M1)					
390T, 398, 698T, 1004T, 3065, 3065S, 3070	AT4.236	30/15-1 (0410236, 731008M1, 3819719M1)		30/25-11 (ZZ90013, 3637028M91)	30/26-2 (32762145, 4222485M1)	30/27-2 (33221328, 3637030M1)	30/28-16 (31134131, 744971M1)
393TLX, 394TAQ, 396CT, 397T, 1007	AT4.236	30/15-13 (3552228M1)	30/16-1 (0921062, 731192M1)				
178, 185, 188, 194, 285, 290, 293, 294, 590	A4.248	30/15-1 (0410236, 731008M1, 3819719M1)		30/25-3 (ZZ90009, 3637034M91)			30/28-2 (31134123, 733767M1)
290E, 382N, 390, 390E, 690, 3055, 3060	A4.248						
393, 394 (⇨ 12/94)							
393, 394 (1/95 ⇨)							
396C, 397, 3235	A4.248	30/15-13 (3552228M1)					

Part numbers are quoted for reference purposes only.
Our parts and accessories are not original.

Las referencias originales tienen un propósito identificativo.
Nuestras piezas no son originales.



CONNECTING RODS & RELATED PARTS
BIELAS Y PIEZAS RELACIONADAS

For the flywheel
assy. see
page 232
*Para volante
del motor ver
página 232*

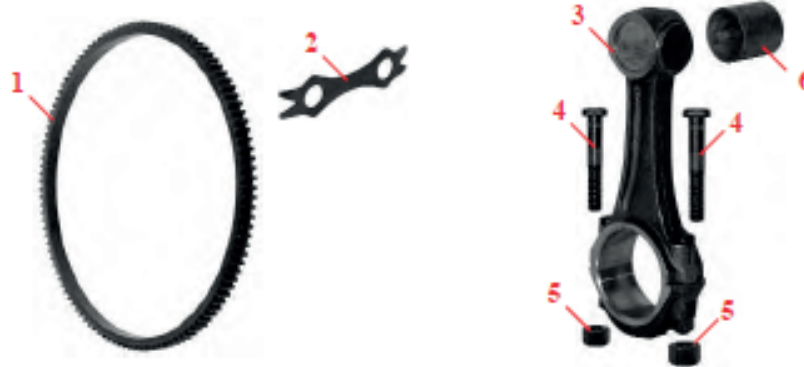

Tractors <i>Tractores</i>	Engine <i>Motor</i>	1 Ring gear <i>Corona de volante</i>	2 Tab washer <i>Chapa seguro</i>	3 Conrod <i>Biela</i>	4 Conrod bolt <i>Tornillo biela</i>	5 Conrod nut <i>Tuerca de biela</i>	6 Small end bush <i>Casquillo pie de biela</i>
4 cylinder engines / Motores 4 cilindros							
285 (USA), 592, 595, 1080, 1085	A4.318	30/15-5 (0410264, 731988M1)	30/16-1 (0921062, 731192M1)				30/28-8 (0050128, 731463M1)
285 (USA), 298, 592, 595, 698, 1004	A4.318.2						
275E, 290E, 375E, 390E, 4225, 4235, 4240, 6110, 6120	A4.41 (Blue)	30/15-1 (0410236, 731008M1, 3819719M1)		30/25-3 (ZZ90009, 3637034M91)			30/28-2 (31134123, 733767M1)
3075, 4245, 4255, 6130, 6140, 6150	1004.4T (Blue)			30/25-11 (ZZ90013, 3637028M91)			30/28-16 (31134131, 744971M1)
374, 3220, 3330	1004.40 (Green)				30/26-2 (32762145, 4222485M1)	30/27-2 (33221328, 3637030M1)	
3350, 3355	1004.40T (Green)	30/15-13 (3552228M1, 0.011.9771.0)					
394, 2230, 3235, 3340	1004.42 (Green)						
4235 (USA), 4335	1004.42 (Green)						30/28-41 (3112E011, 4222131M1)
4225, 4325	1004.40 (Green)	30/15-1 (0410236, 731008M1, 3819719M1)					
4235, 4245, 4255, 4345, 4355, 6235, 6245, 6255	1004.40T (Green)				30/26-13 (32186142, 4222132M1)		
4265, 4365, 6265	1004.40TW (Green)						

Part numbers are quoted for reference purposes only.
Our parts and accessories are not original.

*Las referencias originales tienen un propósito identificativo.
Nuestras piezas no son originales.*



CONNECTING RODS & RELATED PARTS
BIELAS Y PIEZAS RELACIONADAS

For the flywheel
assy. see
page 232
Para volante
del motor ver
pagina 232



Tractors Tractores	Engine Motor	1 Ring gear Corona de volante	2 Tab washer Chapa seguro	3 Conrod Biela	4 Conrod bolt Tornillo biela	5 Conrod nut Tuerca de biela	6 Small end bush Casquillo pie de biela
6 cylinder engines / Motores 6 cilindros							
1100	A6.354	30/15-5 (0410264, 731988M1)	30/16-1 (0921062, 731192M1)	30/25-3 (ZZ90009, 3637034M91)	30/26-2 (32762145, 4222485M1)	30/27-2 (33221328, 3637030M1)	
1014, 1104	A6.354.1	30/15-14 (31162121, 738588M1)					
1200	A6.354.1	30/15-16 (31161148, 747694M1, 3819720M1)					
399, 699	A6.354.4	30/15-5 (0410264, 731988M1)					
1014, 1024, 1114	A6.354.4	30/15-14 (31162121, 738588M1)					
1250	A6.354.4	30/15-7 (1619032M1, 31162126, 741138M1)	30/16-1 (0921062, 731192M1)				
2620, 2625, 2640, 2645, 3080, 3090, 3610	A6.354.4	30/15-5 (0410264, 731988M1)	30/16-1 (0921062, 731192M1)				
2675	A6.354.4	30/15-7 (1619032M1, 31162126, 741138M1)	30/16-1 (0921062, 731192M1)				
1105 1130 1135 1134	ATC6.354.1 AT6.354 AT6.354.1 AT6.354.4	30/15-5 (0410264, 731988M1)	30/16-1 (0921062, 731192M1)				
2680, 2685, 2720, 2725, 3630, 3650	AT6.354.4	30/15-7 (1619032M1, 31162126, 741138M1)	30/16-1 (0921062, 731192M1)				
2705	AT6.354.4					30/28-16 (31134131, 744971M1)	

Part numbers are quoted for reference purposes only.
Our parts and accessories are not original.

Las referencias originales tienen un propósito identificativo.
Nuestras piezas no son originales.



CONNECTING RODS & RELATED PARTS
BIELAS Y PIEZAS RELACIONADAS

For the flywheel
assy. see
page 232
*Para volante
del motor ver
pagina 232*

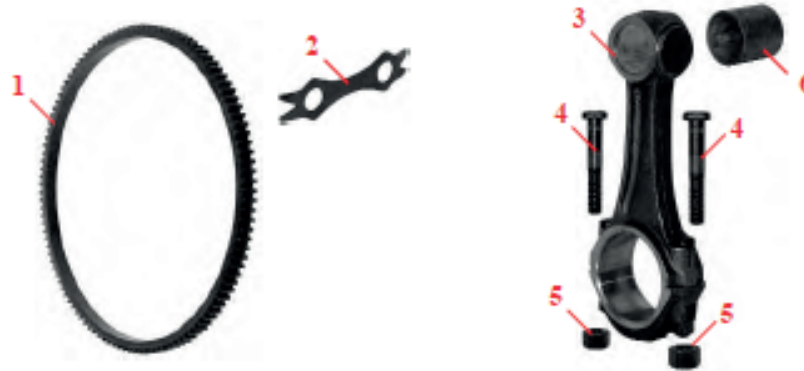

		1	2	3	4	5	6
Tractors <i>Tractores</i>	Engine <i>Motor</i>	Ring gear <i>Corona de volante</i>	Tab washer <i>Chapa seguro</i>	Conrod <i>Biela</i>	Conrod bolt <i>Tornillo biela</i>	Conrod nut <i>Tuerca de biela</i>	Small end bush <i>Casquillo pie de biela</i>
6 cylinder engines / Motores 6 cilindros							
396, 399, 4260, 4270	1006.6 (Blue)	30/15-16 (31161148, 747694M1, 3819720M1)		30/25-3 (ZZ90009, 3637034M91)			30/28-2 (31134123, 733767M1)
3085, 3095, 3115, 6160, 6170	1006.6 (Blue)				30/26-2 (32762145, 4222485M1)	30/27-2 (33221328, 3637030M1)	
3120, 3120T, 3125, 3140, 3635, 6180, 6190, 8110, 8120, 8130	1006.6T (Blue)	30/15-7 (1619032M1)		30/25-11 (ZZ90013, 3637028M91)			30/28-16 (31134131, 744971M1)
3645, 3655, 3660	1006.6T (Blue)		30/16-1 (0921062, 731192M1)				
4260, 4360	1006.60 (Green)	30/15-16 (31161148, 747694M1, 3819720M1)					30/28-40 (3112E005, 4222284M1)
4270, 4370	1006.60T (Green)				30/26-13 (32186142, 4222132M1)		
6170, 6180, 6290, 8120 6270, 6280, 8210, 8220 <i>With air compressor Con compresor de aire</i>	1006.60T (Green)	30/15-7 (1619032M1)					30/28-41 (3112E011, 4222131M1)
6260 6270, 6280, 8210, 8220	1006.60 1006.60T				30/26-2 (32762145, 4222485M1)	30/27-2 (33221328, 3637030M1)	

Part numbers are quoted for reference pu poses
only. Our parts and accessories are not original.

*Las referencias originales tienen un propósito identificativo.
Nuestras piezas no son originales.*



CONNECTING RODS & RELATED PARTS
BIELAS Y PIEZAS RELACIONADAS

For the flywheel
assy. see
page 232
*Para volante
del motor ver
página 232*

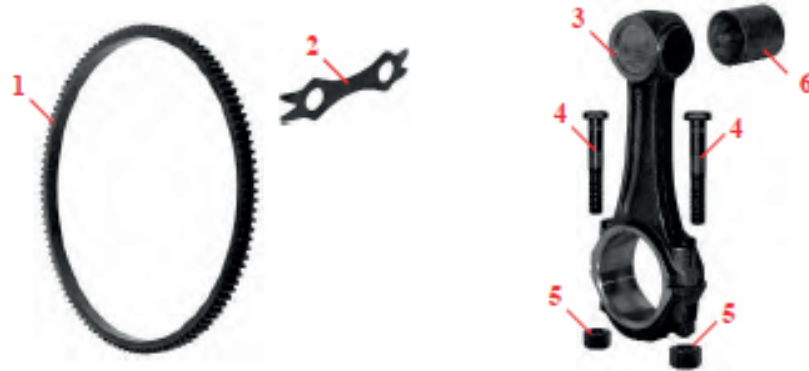

Tractors <i>Tractores</i>	Engine <i>Motor</i>	1 Ring gear <i>Corona de volante</i>	2 Tab washer <i>Chapa seguro</i>	3 Conrod <i>Biela</i>	4 Conrod bolt <i>Tornillo biela</i>	5 Conrod nut <i>Tuerca de biela</i>	6 Small end bush <i>Casquillo pie de biela</i>
6 cylinder engines / Motores 6 cilindros							
3680, 3690	612DS	30/15-7 (1619032M1)					30/28-26 (3637624M1, V836336297)
3670	620DS						+0.5mm 30/28-32 (3637625M1, V836338606)
8140 (⇔ G331001) 8150 (⇔ G317024)	620DS						(⇔ L11211)
8140 (G331002 ⇔) 8150 (G317025 ⇔) <i>With damper / Con amortiguador</i>	620DS						30/28-27 (3638959M1, V836646271)
8240	620DSRAE						(L11212 ⇔)
8240Xtra	620DWB AE						30/28-28 (V836110646)
3690	634DS	30/15-7 (1619032M1)					
8160 (⇔ G331006)	634DS						
8160 (G331007 ⇔) <i>With damper / Con amortiguador</i>	634DS						
8250, 8260	634DSBAE						
8260	634DSBIE						
8250Xtra, 8260Xtra	634DWB AE						
8170, 8180	645DSBIE	30/15-7 (1619032M1)					(⇔ L01109)
8270, 8280	645DSBIE						30/28-26 (3637624M1, V836336297)
8270Xtra, 8280Xtra	645DSBAE						+0.5mm 30/28-32 (3637625M1, V836338606)

Part numbers are quoted for reference purposes only.
Our parts and accessories are not original.

*Las referencias originales tienen un propósito identificativo.
Nuestras piezas no son originales.*



CONNECTING RODS & RELATED PARTS
BIELAS Y PIEZAS RELACIONADAS

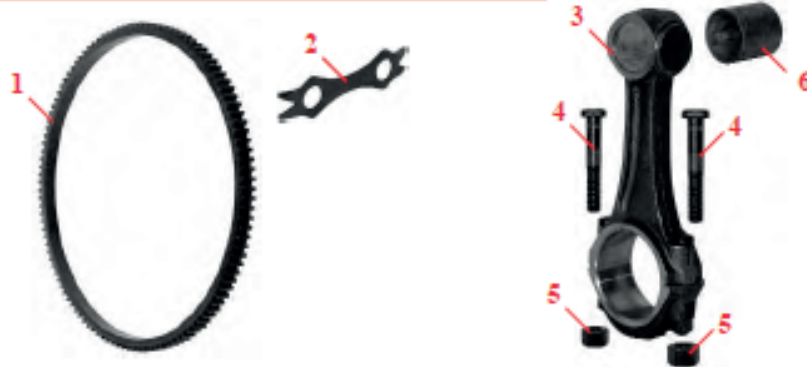

Tractors Tractores	Engine Motor	1 Ring gear Corona de volante	2 Tab washer Chapa seguro	3 Conrod Biela	4 Conrod bolt Tornillo biela	5 Conrod nut Tuerca de biela	6 Small end bush Casquillo pie de biela
4 cylinder engines combines / Cosechadoras motores 4 cilindros							
186	A4.212	30/15-5 (0410264, 731988M1)	30/16-1 (0921062, 731192M1)	30/25-3 (ZZ90009, 3637034M91)			30/28-2 (31134123, 733767M1)
99, 187, 206, 240, 307	A4.236						
8Plot, 10Plot, 16Plot, 16	A4.236						
330	A4.236	30/15-1 (0410236, 731008M1, 3819719M1)					
20XP	AT4.236		30/25-11 (ZZ90013, 3637028M91)	30/26-2 (32762145, 4222485M1)	30/27-2 (33221328, 3637030M1)	30/28-16 (31134131, 744971M1)	
440, 487, 506	A4.248	30/15-5 (0410264, 731988M1)	30/16-1 (0921062, 731192M1)	30/25-3 (ZZ90009, 3637034M91)			30/28-2 (31134123, 733767M1)
20	A4.248						
430	A4.248	30/15-1 (0410236, 731008M1, 3819719M1)					
788	A4.270	30/15-5 (0410264, 731988M1)	30/16-1 (0921062, 731192M1)				30/28-8 (0050128, 731463M1)
400, 410, 415	A4.300						
6 cylinder engines combines / Cosechadoras motores 6 cilindros							
500, 507, 510, 515, 520, 525	A6.354	30/15-5 (0410264, 731988M1)	30/16-1 (0921062, 731192M1)	30/25-3 (ZZ90009, 3637034M91)			30/28-2 (31134123, 733767M1)
530, 530S, 535, 800, 805, 810, 815	A6.354.4						
24, 27	A6.354.4	30/15-14 (31162121, 738588M1)					
750, 760	AT6.354.1		30/16-1 (0921062, 731192M1)	30/25-11 (ZZ90013, 3637028M91)	30/26-2 (32762145, 4222485M1)	30/27-2 (33221328, 3637030M1)	30/28-16 (31134131, 744971M1)
560, 565, 660, 665, 750, 760, 820, 825, 830, 835, 840, 845, 850, 855, 860	AT6.354.4	30/15-5 (0410264, 731988M1)					
29, 29XP, 31, 31XP	AT6.354.4	30/15-14 (31162121, 738588M1)					
620, 625, 740, 750	A6.372	30/15-5 (0410264, 731988M1)	30/16-1 (0921062, 731192M1)	30/25-3 (ZZ90009, 3637034M91)			30/28-2 (31134123, 733767M1)
750	A6.372.4						

Part numbers are quoted for reference purposes only.
Our parts and accessories are not original.

Las referencias originales tienen un propósito identificativo.
Nuestras piezas no son originales.



CONNECTING RODS & RELATED PARTS
BIELAS Y PIEZAS RELACIONADAS

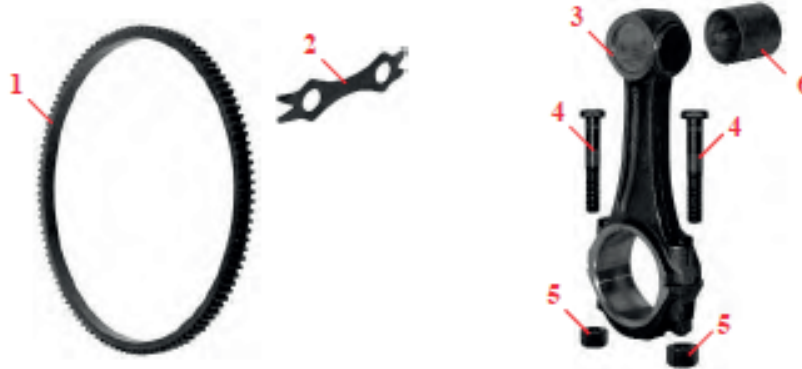

Tractors <i>Tractores</i>	Engine <i>Motor</i>	1 Ring gear <i>Corona de volante</i>	2 Tab washer <i>Chapa segura</i>	3 Conrod <i>Biela</i>	4 Conrod bolt <i>Tornillo biela</i>	5 Conrod nut <i>Tuerca de biela</i>	6 Small end bush <i>Casquillo pie de biela</i>
Telescopic handlers / Carretillas elevadoras telescópicas							
24	A4.236	30/15-1 (0410236, 731008M1, 3819719M1)		30/25-3 (ZZ90009, 3637034M91)			30/28-2 (31134123, 733767M1)
24T	AT4.236			30/25-11 (ZZ90013, 3637028M91)			30/28-16 (31134131, 744971M1)
8925, 8926, 8937, 8939	1004.4 (Blue)			30/25-3 (ZZ90009, 3637034M91)	30/26-2 (32762145, 4222485M1)	30/27-2 (33221328, 3637030M1)	30/28-2 (31134123, 733767M1)
8925, 8926, 8937, 8939	1004.42 (Green)						30/28-41 (3112E011, 4222131M1)
8925T, 8926T, 8937T, 8939T	1004.4T (Blue)	30/15-14 (31162121, 738588M1)		30/25-11 (ZZ90013, 3637028M91)			30/28-16 (31134131, 744971M1)
8925T, 8926T, 8937T, 8939T	1004.40T (Green)				30/26-13 (32186142, 4222132M1)		30/28-41 (3112E011, 4222131M1)
3 cylinder engine industrial tractors / Palas retrocargadoras motores 3 cilindros							
203, 205	A3.152			30/25-1 (ZZ90011, 3637439M91)			
20, 40	AG3.152		30/16-1 (0921062, 731192M1)				
20, 20D, 40, 203, 205, 2135, 2203, 2205	AD3.152	30/15-1 (0410236, 731008M1, 3819719M1)		30/25-2 (ZZ90010, 3637392M91)	30/26-1 (0095250, 375756X1)	30/27-1 (33221327, 1476245X1)	30/28-1 (31134151, 740407M1)
20B, 20C, 20E, 20F, 30B, 30E, 30H	AD3.152						
40E	AT3.152.4						

Part numbers are quoted for reference purposes only.
Our parts and accessories are not original.

Las referencias originales tienen un propósito identificativo.
Nuestras piezas no son originales.



CONNECTING RODS & RELATED PARTS
BIELAS Y PIEZAS RELACIONADAS



		1	2	3	4	5	6
Tractors Tractores	Engine Motor	Ring gear Corona de volante	Tab washer Chapa seguro	Conrod Biela	Conrod bolt Tornillo biela	Conrod nut Tuercas de biela	Small end bush Casquillo pie de biela
4 cylinder engine industrial tractors / Palas retrocargadoras motores 4 cilindros							
702	23C Diesel	30/15-15 (826049M1)					30/28-33 (1884944M1)
356	A4-203			30/25-1 (ZZ90011, 3637439M91)	30/26-1 (0095250, 375756X1)	30/27-1 (33221327, 1476245X1)	30/28-1 (31134151, 740407M1)
30, 40B, 50, 302, 304, 356, 3165, 3303, 3305	AD4-203		30/16-1 (0921062, 731192M1)	30/25-2 (ZZ90010, 3637392M91)			
50, 50B, 3303, 3305	A4-212						
50, 50B, 50B MKII, 50C, 60	A4-236	30/15-1 (0410236, 731008M1, 3819719M1)		30/25-3 (ZZ90009, 3637034M91)			30/28-2 (31134123, 733767M1)
30D, 50D, 50E, 50H, 50H-S, 50H-T	A4-236				30/26-2 (32762145, 4222485M1)	30/27-2 (33221328, 3637030M1)	30/28-16 (31134131, 744971M1)
60HX, 60HX-T	AT4-236			30/25-11 (ZZ90013, 3637028M91)			
50EX, 50HX, 50HX-S, 50HX-T, 60H, 60H-S	A4-248			30/25-3 (ZZ90009, 3637034M91)			30/28-2 (31134123, 733767M1)
70	A4-318	30/15-5 (0410264, 731988M1)	30/16-1 (0921062, 731192M1)				30/28-8 (0050128, 731463M1)
Ferret & Terex - 4 cylinder engine industrial tractors / Palas retrocargadoras motores 4 cilindros							
750	1004-4 (Blue)			30/25-3 (ZZ90009, 3637034M91)			30/28-2 (31134123, 733767M1)
750, 750B	1004-42 (Green)	30/15-1 (0410236, 731008M1, 3819719M1)			30/26-2 (32762145, 4222485M1)	30/27-2 (33221328, 3637030M1)	30/28-41 (3112E011, 4222131M1)
760, 860, 860S, 860SE, 865, 960, 965	1004-4T (Blue)			30/25-11 (ZZ90013, 3637028M91)			30/28-16 (31134131, 744971M1)
760, 760B, 860, 860B, 860S, 860SE, 960, 960B, 965	1004-40T (Green)				30/26-13 (327186142, 4222132M1)		30/28-41 (3112E011, 4222131M1)

Part numbers are quoted for reference purposes only.
Our parts and accessories are not original.

Las referencias originales tienen un propósito identificativo.
Nuestras piezas no son originales.



ENGINE OVERHAUL KITS
JUEGOS COMPLETOS DE REPARACIÓN DE MOTOR

Contents : Pistons, rings & liners
Front & rear oil seals
Conrod bushes & nuts
Top & bottom gasket sets

Se incluye : Pistones, segmentos y camisas
Retenes delantero y trasero
Casquillos y tornillos de biela
Juego de juntas superior
Juego de juntas inferior

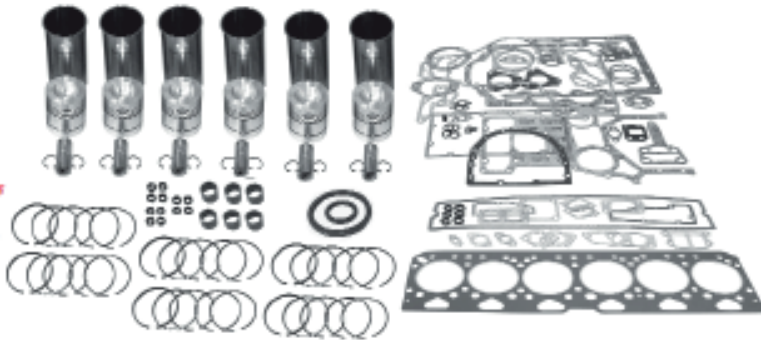

Engines Motores	Overhaul kit / Juegos completos de reparación	
	With finished liner Con camisa terminada	With semi-finished liner Con camisa semi-terminada
A3.144		30/30-181S (A) (U5MK0321, 3638892M91)
A3.152 (Chrome liner / Camisa cromada)	30/30-100 (U5MK0290, 3639495M1)	
A3.152 (Cast iron liner / Camisa acero)	30/30-101 (U5MK0291, 3639496M1)	30/30-101S (B30101S)
AD3.152 (5 ring piston / Pistón 5 segmentos)	30/30-102 (A) (U5MK0292, U5MK0701, 3638583M91, 4223470M91)	30/30-102S (A) (U5MK0701K)
AD3.152 (4 ring piston / Pistón 4 segmentos)	30/30-103 (A) (U5MK0288, U5MK0700, 3638581M91)	30/30-103S (A) (U5MK0700K)
AT3.152.4		30/30-105S (U5MK0277, 3639486M1)
A4.107	30/30-106 (U5MK0289, 3639494M1)	
AD4.203	30/30-107 (A) (U5MK0293, 3638495M91)	30/30-107S (A) (B30107S)
A4.212	30/30-108 (A) (U5MK0294, 3638584M91)	30/30-108S (A) (B30108S)
A4.236 (⇔ U106653N) Early blocks 103.19mm bore Ø - Liner with flame ring Primeros bloques 103,19mm diametro de cilindro. Camisa con cortafuegos	30/30-110 (A) (U5MK0281, U5MK0704, 3638582M91)	30/30-110S (A) (U5MK0704K)
A4.236 (U106653N ⇔) Later blocks 104.20mm bore Ø - Liner without flame ring Últimos bloques 104,20mm diametro de cilindro. Camisa sin cortafuegos	30/30-111 (U5MK0278, U5MK0713, 3639487M1)	30/30-111S (U5MK0713K)
AT4.236 (⇔ U027773M) Early blocks 103.19mm bore Ø - Liner with flame ring Primeros bloques 103,19mm diametro de cilindro. Camisa con cortafuegos	30/30-112 (U5MK0280, 3639489M1)	30/30-112S (B30112S)
AT4.236 (U027774M ⇔) Later blocks 104.20mm bore Ø - Liner without flame ring Últimos bloques 104,20mm diametro de cilindro. Camisa sin cortafuegos	30/30-113 (U5MK0282, U5MK0705, 3639490M1, 4222076M91)	30/30-113S (U5MK0705K)

(A) The kit includes both rope and lip rear oil seals
Los juegos incluyen dos retenes traseros, labrado y de cuerda.

NB Valve components are not included in these kits. For details of valve train kits see page MF-60
Las válvulas y piezas relacionadas no están incluidas en estos juegos. Para más detalles de los juegos de válvulas, ver página MF-60



The components within these kits should not be mixed with older components.
These kits are stock items. We are happy to make up kits to your requirements.
*Los componentes de estos juegos no deben ser mezclados en el montaje con otros viejos.
Estos juegos se almacenan para servicio. Nos complacerá preparar un juego según sus necesidades.*

Part numbers are quoted for reference purposes only.
Our parts and accessories are not original.

*Las referencias originales tienen un propósito identificativo.
Nuestras piezas no son originales.*



ENGINE OVERHAUL KITS
JUEGOS COMPLETOS DE REPARACIÓN DE MOTOR

Contents : Pistons, rings & liners
Front & rear oil seals
Conrod bushes & nuts
Top & bottom gasket sets

Se incluye : Pistones, segmentos y camisas
Retenes delantero y trasero
Casquillos y tornillos de biela
Juego de juntas superior
Juego de juntas inferior

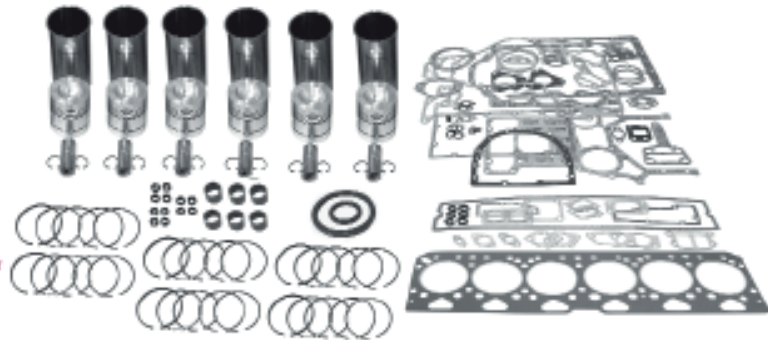

Engines Motores	Overhaul kit / Juegos completos de reparación	
	With finished liner Con camisa terminada	With semi-finished liner Con camisa semi-terminada
A4.248 (Parallel liner / Camisa cilíndrica)		30/30-114S (A) (U5MK0287, 3638580M91)
A4.248 (U108196N) Liner with flame ring / Camisa con cortafuegos	30/30-115 (A) (U5MK0155, U5MK0706, 3637612M91, 4222356M91)	30/30-115S (A) (U5MK0706K)
A4.248 (U108197N) Liner without flame ring / Camisa sin cortafuegos	30/30-116 (U5MK0279, 3638585M91)	30/30-116S (B30116S)
A4.318.2	30/30-117 (A) (U5MK0295, 3638586M91)	30/30-117S (A) (B30117S)
A4.41	30/30-186 (4222910M91)	30/30-186S (B30186S)
A6.354.4	30/30-118 (U5MK0283, U5MK0710, 3639491M1, 4224394M91)	30/30-118S (U5MK0710K)
AT6.354.4	30/30-119 (U5MK0284, U5MK0711, 3639492M1)	30/30-119S (U5MK0711K)
1004.4 (Blue)	30/30-182 (U5MK0708)	30/30-182S (U5MK0708K)
1004.4T (Blue)	30/30-183 (U5MK0709, 4222909M91)	30/30-183S (U5MK0709K)
1006.6 (Blue)	30/30-184 (U5MK0319, U5MK0714, 3931493M91)	30/30-184S (U5MK0714K)
1006.6T (Blue)	30/30-185 (U5MK0320, U5MK0712, 4222908M91)	30/30-185S (U5MK0712K)

(A) The kit includes both rope and lip rear oil seals
Los juegos incluyen dos retenes traseros, labiado y de cuerda.

NB Valve components are not included in these kits. For details of valve train kits see page MF-60
Las válvulas y piezas relacionadas no están incluidas en estos juegos. Para más detalles de los juegos de válvulas, ver página MF-60



The components within these kits should not be mixed with older components.
These kits are stock items. We are happy to make up kits to your requirements.
*Los componentes de estos juegos no deben ser mezclados en el montaje con otros viejos.
Estos juegos se almacenan para servicio. Nos complacerá preparar un juego según sus necesidades.*

Part numbers are quoted for reference purposes only.
Our parts and accessories are not original.

*Las referencias originales tienen un propósito identificativo.
Nuestras piezas no son originales.*



PISTONS, RING SETS & LINERS
PISTONES, JUEGOS DE SEGMENTOS & CAMISAS



		1	2	3	4	5	6
Tractors Tractores	Engine Motor	Kit set Juego	Piston & rings Pistón con aros	Piston & pin Pistón sin aros	Ring set Juego de segm.	Finished liner Camisa term.	Semi-finished liner Camisa semi-term.
3 cylinder engines / Motores 3 cilindros							
35, 133, 135	A3.144	30/31-3 (B1129)	30/32-3 (55275)	30/33-3 (55274, 739845M91)	30/34-3 (41158063, 745823M91)	30/35-3 (0530017)	30/36-3 (0530002, 731595M1)
35 Chrome liner Camisa cromada	A3.152	30/31-4 (U5MK0064, 3639471M1)	30/32-4 (68503, 3640441M91)	30/33-4 (A) (81512, 734460M91)	30/34-4 (41158058, 745819M91)	30/35-4 (31358308, 732638M1)	
35 Cast iron liner Camisa acero	A3.152	30/31-5 (U5MK0033, 3640482M91)	30/32-5 (68502, 3639047M1)		30/34-7 (41158057, 745818M91)		
135	AG3.152	30/31-11 (B3111)	30/32-11 (B3211)	30/33-11 (86723, 738287M91)	30/34-11 (41158012, 745815M91)		
133, 134, 135, 140, 145, 150, 230, 233, 234, 235, 240, 245, 333, 334V, 340 354 (CE31223, CE31224)	AD3.152	30/31-7 (U5MK0034, 3637428M91)	30/32-7 (68504, 3639048M1)	30/33-7 (68332, 743824M91)	30/34-7 (41158057, 745818M91)	30/35-7 (31358345, 739043M1)	30/36-7 (31358323, 734179M1)
148, 152, 154, 235 (USA), 244CF, 245 (USA), 250, 253 (Italy), 254, 255, 342, 350, 550, 2205	AD3.152	30/31-8 (U5MK0117, 3638883M91)		30/33-8 (89214, 742621M91)	30/34-8 (41158065, 745826M91)		
353, 354 (CE31197, CE31212) 356CF, 3210 Flanged liner Camisa con pestaña	AD3.152		30/32-8 (U5PR.0002)				
353, 354 (CE31197, CE31212) 356CF, 3210 Parallel liner Camisa cilíndrica	AD3.152	30/31-81S (B3181S)					30/36-24 (31358356, 3637492M1)
164T, 263T, 264T, 352	AT3.152.4						
253 (UK), 355, 360, 363, 364, 366CF Flanged liner Camisa con pestaña	AT3.152.4	30/31-140 (B31140)			30/34-71 (H) (41158144, 3637658M91)	30/35-7 (31358345, 739043M1)	30/36-7 (31358323, 734179M1)
253 (UK), 355, 360, 363, 364, 366CF Parallel liner Camisa cilíndrica	AT3.152.4	30/31-72S (B3172S)	30/32-72 (B3272)	30/33-72 (U5LL0044, 4224456M91)	30/34-72 (4181A017, 3638235M91)		30/36-24 (31358356, 3637492M1)
2210, 3315, 4215, 4315	903.27	30/31-177S (B31177S)	30/32-177 (B32177)	30/33-177 (F) (U5LH0006, 4223808M91)	30/34-177 (4181A035, 4222577M91)		30/36-177 (3135P001, 4222570M91)
263 (UK), 2220, 3325, 4220, 4320	903.27T	30/31-178S (B31178S)	30/32-178 (B32178)	30/33-178 (G) (U5LH0007, 4224102M91)	30/34-178 (4181A051, 4222723M91)		

(A) Untopped piston available 30/33-5 equivalent to 68306, 743121M91.

Pistón para rectificar altura disponible, 30/33-5 equivalente a 68306, 743121M91

(F) High grade piston, replace / Pistón de alto grado, sustituye U5LL0030,4223808M91

(G) High grade piston, replace / Pistón de alto grado, sustituye U5LL0029,4222722M91

(H) 30/34-71 is required for piston U5LP0017, 3637513M91 that fitted : / 30/34-71 se usa para pistón U5P0017, 3637513M91 montado en : 164T, 253

(UK) (CN31219), 263T (Italy), 264T, 355 & 360 (CN31187).

Pistón / Pistón U5LP0017, 3637513M91 is replaced by / está sustituido por 30/33-72 + 30/34-72

Part numbers are quoted for reference purposes only.

Our parts and accessories are not original.

Las referencias originales tienen un propósito identificativo.

Nuestras piezas no son originales.



PISTONS, RING SETS & LINERS
PISTONES, JUEGOS DE SEGMENTOS & CAMISAS



Tractor: <i>Tractores</i>	Engine <i>Motor</i>	Kit set <i>Juego</i>	Piston & rings <i>Piston con aros</i>	Piston & pin <i>Piston sin aros</i>	Ring set <i>Juego de segm.</i>	Finished liner <i>Camisa term.</i>	Semi-finished liner <i>Camisa semi-term.</i>
4 cylinder engines / Motores 4 cilindros							
TEA20 TED20 TEH20	85mm Petrol 85mm VO 85mm LO	30/31-40 (B) (883013M91)	30/32-40 (200570)	30/33-40 (B1206)	30/34-40 (B1216)	30/35-40 (893007M1)	
TEF20	20C Diesel	30/31-1 (883015M91)	30/32-1 (115741F)	30/33-1 (B1208)	30/34-1 (B1218)	30/35-1 (106594F)	
FE35, 835	23C Diesel	30/31-2 (830972M92)	30/32-2 (B1199)	30/33-2 (1884101M91)	30/34-2 (894900M91)	30/35-2 (1884940M1)	
35, 135	87mm Petrol	30/31-41 (B) (B1125)	30/32-41 (826276M91)	30/33-41 (B1209)	30/34-41 (B1219)	30/35-41 (825861M1)	
25, 30, 130, 825	A4.107	30/31-16 (U5MK0036, 3637429M91)	30/32-16 (68517)	30/33-16 (89216, 741335M91)	30/34-16 (41158085, 745902M91)	30/35-16 (31358116, 734127M1)	
65	A4.192	30/31-3 (B1129)	30/32-3 (55275)	30/33-3 (55274, 739845M91)	30/34-3 (41158063, 745823M91)	30/35-3 (0530017)	30/36-3 (0530002, 731595M1)
65, 865 <i>Chrome liner Camisa cromada</i>	A4.203	30/31-4 (U5MK0064, 3639471M1)	30/32-4 (68503, 3640441M91)	30/33-4 (A) (81512, 734460M91)	30/34-4 (41158058, 745819M91)	30/35-4 (31358308, 732638M1)	
65, 865 <i>Cast iron liner Camisa acero</i>	A4.203	30/31-5 (U5MK0033, 3640482M91)	30/32-5 (68502, 3639047M1)		30/34-7 (41158057, 745818M91)	30/35-7 (31358345, 739043M1)	30/36-7 (31358323, 734179M1)
65, 765 <i>Chrome liner Camisa cromada</i>	AD4.203	30/31-6 (59382)	30/32-6 (82137)		30/34-4 (41158058, 745819M91)	30/35-4 (31358308, 732638M1)	
65, 165, 765, 155, 158, 158MKIII, 260, 560 (⇒ U589378L) <i>Cast iron liner Camisa acero</i>	AD4.203	30/31-7 (U5MK0034, 3637428M91)	30/32-7 (68504, 3639048M1)	30/33-7 (68332, 743824M91)	30/34-7 (41158057, 745818M91)	30/35-7 (31358345, 739043M1)	30/36-7 (31358323, 734179M1)
155, 158, 158MKIII, 260, 560 (U589379L ⇒) <i>Cast iron liner Camisa acero</i>	AD4.203	30/31-8 (U5MK0117, 3638883M91)	30/32-8 (U5PR0002)	30/33-8 (89214, 742621M91)	30/34-8 (41158065, 745826M91)		

(A) Untopped piston available 30/33-5 equivalent to 68306, 743121M91.
Piston para rectificar altura disponible, 30/33-5 equivalente a 68306, 743121M91

(B) 30/31-40 & 30/31-41 kit sets are supplied complete with spectacle gasket.
Los juegos 30/31-40 & 30/31-41 se sirven completos con junta tórica.

Part numbers are quoted for reference purposes only.
Our parts and accessories are not original.

Las referencias originales tienen un pequeño indentificativo.
Nuestras piezas no son originales.



PISTONS, RING SETS & LINERS
PISTONES, JUEGOS DE SEGMENTOS & CAMISAS



		1	2	3	4	5	6
Tractors Tractores	Engine Motor	Kit set Juego	Piston & rings Pistón con aros	Piston & pin Pistón sin aros	Ring set Juego de segm.	Finished liner Camisa term.	Semi-finished liner Camisa semi-term.
4 cylinder engines / Motores 4 cilindros							
165 (Rope seal / Retén de cuerdas) 3 ring piston / 3 segmentos	A4.212	30/31-10 (B1102)	30/32-10 (68515)	30/33-10 (89206, 740082M91)	30/34-10 (41158045, 745764M91)		
165, 174 (Lip seal / Retén de labios) 4 ring piston / 4 segmentos	A4.212	30/31-9 (U5MK0066, 3637432M91)	30/32-9 (68514, 1896435M91)	30/33-9 (86721, 738249M91)	30/34-9 (41158044, 745763M91)		
168, 175, 184 (Rope seal / Retén de cuerdas)	A4.236	30/31-12 (U5MK0038, 3637430M91)	30/32-12 (68506, 3640442M91)	30/33-12 (82878, 735187M91)		30/35-14 (31358394, 744948M1)	30/36-14 (31358393, 744131M1)
168, 175, 184 (Lip seal / Retén de labios) 174, 255 (USA), 265, 273, 274, 275, 283, 284, 565, 575, 675, 3050 Early blocks 103.19mm bore Ø Primeros bloques 103.19mm Ø	A4.236	30/31-14 (U5MK0171, 3638888M91)					
168, 174, 184, 255 (USA), 265, 273, 274, 275, 283, 284, 565, 575, 675, 3050 Later blocks 104.20mm bore Ø Últimos bloques 104.20mm Ø	A4.236		30/32-69 (68516, 3639051M1)	30/33-69 (68301, U5LP0035, 743110M91, 3637516M91)	30/34-12 (41158041, 745760M91)	30/35-22 (3135X032, 3637332M1)	30/36-22 (3135X031, 3637331M1)
168 MKIII, 275E, 362, 362N, 365, 367CF, 372N, 373, 374, 375, 375E, 376C, 377, 383, 384, 387, 3220, 3225	A4.236						
698T, 1004T (⇒ U027773M) Early blocks 103.19mm bore Ø Primeros bloques 103.19mm Ø	AT4.236	30/31-60 (B3160)				30/35-14 (31358394, 744948M1)	30/36-14 (31358393, 744131M1)
393TLX, 394TAQ, 396CT, 397T, 698T, 1004T, 3065 (⇒ U027773M) Later blocks 104.20mm bore Ø Últimos bloques 104.20mm Ø	AT4.236	30/31-73 (B3173)	30/32-73 (B3273)	30/33-73 (U5LP0006, 3639434M1)	30/34-78 (41158005, 745277M91)	30/35-22 (3135X032, 3637332M1)	30/36-22 (3135X031, 3637331M1)
393TLX, 394TAQ, 396CT, 397T, 698T, 1004T, 3065 (U027774M ⇒) 390T, 398, 1007, 3065S, 3070	AT4.236	30/31-74 (U5MK0169)	30/32-74 (U5PR0025, 3639514M1)	30/33-74 (U5LP0022, 3637360M91)	30/34-74 (+181A022, 3638721M91)		

Part numbers are quoted for reference purposes only.
Our parts and accessories are not original.

Las referencias originales tienen un propósito identificativo.
Nuestras piezas no son originales.



PISTONS, RING SETS & LINERS
PISTONES, JUEGOS DE SEGMENTOS & CAMISAS



Tractors Tractores	Engine Motor	1 Kit set Juego	2 Piston & rings Pistón con aros	3 Piston & pin Pistón sin aros	4 Ring set Juego de segm.	5 Finished liner Camisa term.	6 Semi-finished liner Camisa semi-term.
4 cylinder engines / Motores 4 cilindros							
178, 185, 188	A4.248	30/31-135 (U5MK0039, 3637431M91)	30/32-13 (68508, 3639050M1)	30/33-13 (89207, 740821M91)	30/34-13 (4181A009, 747041M91)		30/36-13 (31358343, 737214M1)
194, 285, 290, 293, 294, 590, 690 (⇒ U839079J)	A4.248	30/31-15 (U5MK0067, 3638866M91)					
194, 285, 290, 293, 294, 590, 690 (U839080J ⇒)	A4.248	30/31-57 (B1126)				30/35-15 (31358352, 742466M1)	30/36-15 (31358346, 740571M1)
194, 290, 290E, 293, 294, 362N, 390, 390E, 393, 394, 396C, 397, 3055, 3060, 3235	A4.248	30/31-58 (B3158)	30/32-57 (B1226)	30/33-57 (U5LP0009, 747050M91)	30/34-57 (41158022, 747428M91)		
285 (USA), 592, 595, 1080, 1085	A4.318	30/31-21 (B1111)	30/32-21 (B1211)	30/33-21 (86716, 738106M91)	30/34-21 (41158118, 745950M91)	30/35-21 (31358534, 745991M1)	30/36-21 (31358533, 745990M1)
285 (USA), 298, 592, 595, 698, 1004	A4.318.2	30/31-59 (U5MK0029, 746792M91)	30/32-59 (U5PR0045)	30/33-59 (68810, 746251M91)	30/34-59 (41158132, 746163M91)		
275E, 290E, 375E, 390E, 4225, 4235, 4240, 6110, 6120	A4.41 (Blue)	30/31-183 (B31183)	30/32-183 (B32183)	30/33-183 (U5LL0031, 4223499M91)	30/34-183 (4115Y001, 4222053M91)	30/35-23 (3135X034, 3637334M1)	30/36-23 (3135X033, 3637333M1)
3075, 6130, 6140, 6150	1004.4T (Blue)	30/31-108 (U5MK0275, 3640333M91)	30/32-108 (U5PR0040, 3640334M91)	30/33-108 (U5LL0014, 3640593M91)			
4245, 4255 (⇒ U947668E)	1004.4T (Blue)	30/31-179 (B31179)	30/32-179 (B32179)	30/33-179 (U5LL0039, 4223849M91)	30/34-108 (4181A026, 3641316M91)	30/35-108 (3135X042, 748216M1)	30/36-108 (3135X041, 748215M1)
374, 3220, 3330, 4225, 4325	1004.40 (Green)						
3350, 3355, 4235, 4245, 4255, 4345, 4355, 6235, 6245, 6255	1004.40T (Green)	30/31-173 (B31173)	30/32-173 (U5PR0054)	30/33-173 (U5LP0057, 4222134M91)	30/34-173 (4181A033, 4222136M91)	30/35-173 (3135X062, 4222128M1)	30/36-173 (3135X063, 4222129M1)
4265, 4365, 6265	1004.40 TW						
394, 2230, 3235, 3240, 4235 (USA), 4335	1004.42 (Green)		30/32-182 (B32182)	30/33-182 (U5LP0058, 4222949M91)	30/34-182 (4181A045, 4222950M91)		

Part numbers are quoted for reference purposes only.
Our parts and accessories are not original.

Las referencias originales tienen un propósito identificativo.
Nuestras piezas no son originales.



PISTONS, RING SETS & LINERS
PISTONES, JUEGOS DE SEGMENTOS & CAMISAS



		1	2	3	4	5	6
Tractors Tractores	Engine Motor	Kit set Juego	Piston & rings Pistón con aros	Piston & pin Pistón sin aros	Ring set Juego de segm.	Finished liner Camisa term.	Semi-finished liner Camisa semi-term.
6 cylinder engines / Motores 6 cilindros							
1100 1014, 1104 <i>Std ring set / Estándar segm.</i>	A6.354 A6.354.1	30/31-70 (U5MK0127, 3638885M91)	30/32-22 (68509, 3641196M91)	30/33-18 (86740, 738871M91)	30/34-12 (C) (41158041, 745760M91)		
1100 1014, 1104 <i>Ring set Duraflex Segmentos</i>	A6.354 A6.354.1	30/31-18 (B1114)	30/32-18 (68510)		30/34-18 (41158029, 745750M91)		
1200	A6.354.1	30/31-24 (U5MK0125)	30/32-24 (68512, 3641425M91)	30/33-24 (86745, 3637280M91)	30/34-24 (41158032, 745752M91)		
1014 (TW31087 → U725809L) 2620, 2625 (→ U653769H)	A6.354.4	30/31-70 (U5MK0127, 3638885M91)	30/32-22 (68509, 3641196M91)	30/33-18 (86740, 738871M91)	30/34-12 (41158041, 745760M91)	30/35-14 (31358394, 744948M1)	30/36-14 (31358393, 744131M1)
399, 699 1014 (TW31087 U725810L →) 1014 (TW31147) 1024, 1114, 1250 2620, 2625 (U653770H →) 2640, 2645, 2675, 3080, 3090, 3610	A6.354.4	30/31-77 (B3177)	30/32-77 (B3277)	30/33-77 (U5LP0021, 748266M91)	30/34-75 (41158017, 745738M91)		
1105 1130 1135	AT6.354.1 AT6.354 AT6.354.1	30/31-23 (B1123)	30/32-23 (B1223)	30/33-23 (86726, 738368M91)	30/34-23 (41158031, 745751M91)		
1134, 2680, 2685, 2705, 2720, 2725, 3630, 3650	AT6.354.4	30/31-78 (U5MK0071, 3637766M91)	30/32-78 (U5PR0011, 3641413M91)	30/33-78 (68803, 745379M91)	30/34-78 (41158005, 745277M91)		
396, 399, 4260, 4270 (→ U593765A) 3085, 3095, 3115, 6160, 6170 (→ U646982C)	1006.6 (Blue)	30/31-109 (U5MK0142, 3637661M91)	30/32-109 (U5PR0016, 3637662M91)	30/33-109 (U5LL0015, 3638989M91)	30/34-110 (4181A019, 3637033M91)	30/35-108 (3135X042, 748216M1)	30/36-108 (3135X041, 748215M1)
396, 399, 4260, 4270 (U593766A →) 3085, 3095, 3115, 6160, 6170 (U646983C →)	1006.6 (Blue)	30/31-176 (B31176)	30/32-176 (B32176)	30/33-176 (U5LL0021, 3641806M91)	30/34-176 (4181A041, 4222706M91)		

(C) Alternative ring available 30/34-12T equivalent to 41158026, 745747M91.
También disponible: segmentos 30/34-12T (41158026, 745747M91).

Part numbers are quoted for reference purposes only.
Our parts and accessories are not original.

Las referencias originales tienen un propósito identificativo.
Nuestras piezas no son originales.



PISTONS, RING SETS & LINERS
PISTONES, JUEGOS DE SEGMENTOS & CAMISAS



		1	2	3	4	5	6
Tractors <i>Tractores</i>	Engine <i>Motor</i>	Kit set <i>Juego</i>	Piston & rings <i>Pistón con aros</i>	Piston & pin <i>Pistón sin aros</i>	Ring set <i>Juego de segm.</i>	Finished liner <i>Camisa term.</i>	Semi-finished liner <i>Camisa semi-term.</i>
6 cylinder engines / Motores 6 cilindros							
3120, 3120T, 3125, 3140, 3635, 3645, 3655, 3660, 6180, 6190, 8110, 8120, 8130	1006.6T (Blue)	30/31-108 (U5MK0275, 3640333M91)	30/32-108 (U5PR0040, 3640334M91)	30/33-108 (U5LL0014, 3640593M91)	⇒ U557976X 30/34-90 (D) (4181A021, 3637032M91) U557977X ⇒ 30/34-108 (4181A026, 3641316M91)	30/35-108 (3135X042, 748216M1)	30/36-108 (3135X041, 748215M1)
4260, 4360, 6260	1006.60 (Green)	30/31-173 (B31173)	30/32-173 (U5PR0054)	30/33-173 (U5LP0057, 4222134M91)	30/34-173 (4181A033, 4222136M91)	30/35-173 (3135X062, 4222128M1)	30/36-173 (3135X063, 4222129M1)
4270, 4370, 6170, 6180, 6270, 6280, 6290, 8120, 8210, 8220	1006.60T (Green)						
Tractors <i>Tractores</i>	Engine <i>Motor</i>	Kit set <i>Juego</i>	Piston & rings <i>Pistón con aros</i>	Piston & pin <i>Pistón sin aros</i>	Ring set <i>Juego de segm.</i>	Finished liner <i>Camisa term.</i>	Seal kits <i>Jgo juntas tóricas</i>
3680, 3690	612DS				30/34-175 (V836339201, 3637620M91)		30/37-175 (2xV835336903+ 1xV835322233, 2x3637623M1+ 1x3637622M1)
3670, 8140, 8150	620DS	30/31-174 (B31174)	30/32-174 (B32174)	30/33-174 (V836640073 3638609M1)	30/34-174 (V836640078, 3638610M91)	30/35-174 (V836647420, 3638970M1)	30/37-174 (2xV836647502+ 1xV836647503)
8240	620DSRAE						
8240Xtra	620DWB AE						
3690, 8160	634DS						
8250, 8260	634DSBAE						
8260	634DSBIE						
8250Xtra, 8260Xtra	634DWB AE						

(D) 30/34-90 is required for piston U5LL0013, 3638796M91 that fitted early versions of the 3100 and 3600 series tractors.

Piston U5LL0013, 3638796M91 is replaced by 30/33-108+30/34-108

30/34-90 se usa para pistón U5LL0013, 3638796M91 montados sobre las primeras versiones de las series 3100 y 3600 de tractores.

Pistón U5LL0013, 3638796M91 está sustituido por 30/33-108+30/34-108

Part numbers are quoted for reference purposes only.
Our parts and accessories are not original.

Las referencias originales tienen un propósito identificativo.
Nuestras piezas no son originales.



PISTONS, RING SETS & LINERS PISTONES, JUEGOS DE SEGMENTOS & CAMISAS



Tractors Tractores	Engine Motor	Kit set Juego	1 Piston & rings Pistón con aros	2 Piston & pin Pistón sin aros	3 Ring set Juego de segm.	4 Finished liner Camisa term.	5 Semi-finished liner Camisa semi-term.	6
4 cylinder engines combines / Cosechadoras motores 4 cilindros								
186	A4.212	30/31-200S (B31200S)	30/32-9 (68514, 1896435M91)	30/33-9 (86721, 738249M91)	30/34-9 (41158044, 745763M91)			
99, 187 206, 307 <i>(Rope seal / Retén de cuerdas)</i>	A4.236	30/31-201S (U5MK0037, 3639468M1)	30/32-12 (68506, 3640442M91)	30/33-12 (82878, 735187M91)				30/36-18 (31358324, 734644M1)
8Plot, 10Plot, 16Plot, 16 206, 307 <i>(Lip seal / Retén de labios)</i>	A4.236	30/31-202S (U5MK0065, 3639472M1)	30/32-69 (68516, 3639051M1)	30/33-69 (68301, U5LP0035, 743110M91, 3637516M91))	30/34-12 (41158041, 745760M91)			
20XP (⇒ U027773M) Early blocks 103.19mm bore Ø <i>Primeros bloques 103.19mm Ø</i>	AT4.236	30/31-60 (B3160)		30/33-73 (U5LP0006, 3639434M1)	30/34-78 (41158005, 745277M91)	30/35-14 (31358394, 744948M1)	30/36-14 (31358393, 744131M1)	
20XP (⇒ U027773M) Later blocks 104.20mm bore Ø <i>Últimos bloques 104.20mm Ø</i>	AT4.236	30/31-73 (B3173)	30/32-73 (B3273)				30/36-22 (3135X031, 3637331M1)	
20XP (U027774M ⇒)	AT4.236	30/31-74 (U5MK0169)	30/32-74 (U5PR0025, 3639514M1)	30/33-74 (U5LP0022, 3637360M91)	30/34-74 (4181A022, 3638721M91)			
440, 487, 506	A4.248	30/31-13S (U5MK0039, 3637431M91)	30/32-13 (68508, 3639050M1)	30/33-13 (89207, 740821M91)	30/34-13 (4181A009, 747041M91)			30/36-13 (31358343, 737214M1)
430	A4.248	30/31-203S (B31203S)						
20 With flame ring <i>Camisa con cortafuegos</i>	A4.248	30/31-57 (B1126)	30/32-57 (B1226)	30/33-57 (U5LP0009, 747050M91)	30/34-57 (41158022, 747428M91)	30/35-15 (31358352, 742466M1)	30/36-15 (31358346, 740571M1)	
20 Without flame ring <i>Camisa sin cortafuegos</i>	A4.248	30/31-58 (B3158)				30/35-23 (3135X034, 3637334M1)	30/36-23 (3135X033, 3637333M1)	
788	A4.270	30/31-20 (B1110)	30/32-20 (B1210)	30/33-20 (55737, 3639030M1)	30/34-20 (41158121, 745932M91)	30/35-20 (31358506, 3639874M1)		

Part numbers are quoted for reference purposes only.
Our parts and accessories are not original.

Las referencias originales tienen un propósito identificativo.
Nuestras piezas no son originales.



PISTONS, RING SETS & LINERS
PISTONES, JUEGOS DE SEGMENTOS & CAMISAS



Tractors <i>Tractores</i>	Engine <i>Motor</i>	1 Kit set <i>Juego</i>	2 Piston & rings <i>Pistón con aros</i>	3 Piston & pin <i>Pistón sin aros</i>	4 Ring set <i>Juego de segm.</i>	5 Finished liner <i>Camisa term.</i>	6 Semi-finished liner <i>Camisa semi-term.</i>
6 cylinder engines combines / Cosechadoras motores 6 cilindros							
500, 507, 510, 515, 520, 525	A6.354	30/31-39S (U5MK0040, 3640483M91)	30/32-22 (68509, 3641196M91)	30/33-18 (86740, 738871M91)	30/34-12 (41158041, 745760M91)		30/36-18 (31358324, 734644M1)
24 530, 535, 800, 805	A6.354.4	30/31-70 (U5MK0127, 3638885M91)					
27 530S, 810, 815	A6.354.4	30/31-77 (B3177)	30/32-77 (B3277)	30/33-77 (U5LP0021, 748266M91)	30/34-75 (41158017, 745738M91)		
750, 760	AT6.354.1	30/31-23 (B1123)	30/32-23 (B1223)	30/33-23 (86726, 738368M91)	30/34-23 (41158031, 745751M91)	30/35-14 (31358394, 744948M1)	30/36-14 (31358393, 744131M1)
29, 29XP, 31 560, 565, 660, 665, 750, 760, 820, 825, 830, 835, 840, 845, 850, 855, 860	AT6.354.4	30/31-78 (U5MK0071, 3637766M91)	30/32-78 (U5PR0011, 3641413M91)	30/33-78 (68803, 745379M91)	30/34-78 (41158005, 745277M91)		
31XP	AT6.354.4						
620, 625 740, 750	A6.372						30/36-13 (31358343, 737214M1)
750	A6.372.4					30/35-15 (31358352, 742466M1)	30/36-15 (31358346, 740571M1)
Telescopic handlers / Carretillas elevadoras telescópicas							
24	A4.236	30/31-69 (U5MK0286)	30/32-69 (68516, 3639051M1)	30/33-69 (U5LP0035, 3637516M91)	30/34-12 (41158041, 745760M91)	30/35-22 (3135X032, 3637332M1)	30/36-22 (3135X031, 3637331M1)
24T	AT4.236	30/31-74 (U5MK0169)	30/32-74 (U5PR0025, 3639514M1)	30/33-74 (U5LP0022, 3637360M91)	30/34-74 (4181A022, 3638721M91)		
8925, 8926, 8937, 8939	1004.4 (Blue)	30/31-109 (U5MK0142, 3637661M91)	30/32-109 (U5PR0016, 3637662M91)	30/33-109 (U5LL0015, 3638989M91)	30/34-110 (4181A019, 3637033M91)	30/35-108 (3135X042, 748216M1)	30/36-108 (3135X041, 748215M1)
8925, 8926, 8937, 8939	1004.42 (Green)		30/32-182 (B32182)	30/33-182 (U5LP0058, 4222949M91)	30/34-182 (4181A045, 4222950M91)		
8925T, 8926T, 8937T, 8939T	1004.4T (Blue)	30/31-108 (U5MK0275, 3640333M91)	30/32-108 (U5PR0040, 3640334M91)	30/33-108 (U5LL0014, 3640593M91)	30/34-108 (4181A026, 3641316M91)	30/35-108 (3135X042, 748216M1)	30/36-108 (3135X041, 748215M1)
8925T, 8926T, 8937T, 8939T	1004.40T (Green)	30/31-173 (B31173)	30/32-173 (U5PR0054)	30/33-173 (U5LP0057, 4222134M91)	30/34-173 (4181A033, 4222136M91)	30/35-173 (3135X062, 4222128M1)	30/36-173 (3135X063, 4222129M1)

Part numbers are quoted for reference purposes only.
Our parts and accessories are not original.

Las referencias originales tienen un propósito identificativo.
Nuestras piezas no son originales.



PISTONS, RING SETS & LINERS
PISTONES, JUEGOS DE SEGMENTOS & CAMISAS



		1	2	3	4	5	6
Tractors Tractores	Engine Motor	Kit set Juego	Piston & rings Pistón con aros	Piston & pin Pistón sin aros	Ring set Juego de segm.	Finished liner Camisa term.	Semi-finished liner Camisa semi-term.
3 cylinder engine industrial tractors / Palas retrocargadoras motores 3 cilindros							
203, 205 <i>Chrome liner Camisa cromada</i>	A3.152	30/31-4 (U5MK0064, 3639471M1)	30/32-4 (68503, 3640441M91)	30/33-4 (A) (81512, 734460M91)	30/34-4 (41158058, 745819M91)	30/35-4 (31358308, 732638M1)	
203, 205 <i>Cast iron liner Camisa acero</i>	A3.152	30/31-5 (U5MK0033, 3640482M91)	30/32-5 (68502, 3639047M1)		30/34-7 (41158057, 745818M91)		
20, 40	AG3.152	30/31-11 (B3111)	30/32-11 (B3211)	30/33-11 (86723, 738287M91)	30/34-11 (41158012, 745815M91)		
20, 20B, 20F, 30H 30E (CE31116, CE31182, CE31183) 40 (CE20801, CE31084) 203, 205, 2135, 2203, 2205	AD3.152	30/31-7 (U5MK0034, 3637428M91)	30/32-7 (68504, 3639048M1)	30/33-7 (68332, 743824M91)	30/34-7 (41158057, 745818M91)	30/35-7 (31358345, 739043M1)	30/36-7 (31358323, 734179M1)
20C, 20D, 20E, 30B 30E (CE31144, CE31184) 40 (CE22438)	AD3.152	30/31-8 (U5MK0117, 3638883M91)	30/32-8 (U5PR0002)	30/33-8 (89214, 742621M91)	30/34-8 (41158065, 745826M91)		
40E	AT3.152.4	30/31-140 (B31140)	30/32-72 (B3272)	30/33-72 (U5LL0044, 4224456M91)	30/34-71 (41158144, 3637658M91) 30/34-72 (4181A017, 3638235M91)		
4 cylinder engine industrial tractors / Palas retrocargadoras motores 4 cilindros							
702	23C Diesel	30/31-2 (830972M92)	30/32-2 (B1199)	30/33-2 (1884101M91)	30/34-2 (894900M91)	30/35-2 (1884940M1)	
356 <i>Chrome liner Camisa cromada</i>	A4.203	30/31-4 (U5MK0064, 3639471M1)	30/32-4 (68503, 3640441M91)	30/33-4 (81512, 734460M91)	30/34-4 (41158058, 745819M91)	30/35-4 (31358308, 732638M1)	
356 <i>Cast iron liner Camisa acero</i>	A4.203	30/31-5 (U5MK0033, 3640482M91)	30/32-5 (68502, 3639047M1)		30/34-7 (41158057, 745818M91)	30/35-7 (31358345, 739043M1)	30/36-7 (31358323, 734179M1)
356 <i>Chrome liner Camisa cromada</i>	AD4.203	30/31-6 (59582)	30/32-6 (82137)	30/33-7 (68332, 743824M91)	30/34-4 (41158058, 745819M91)	30/35-4 (31358308, 732638M1)	
30, 40B, 50, 302, 304, 356, 3165, 3303, 3305	AD4.203	30/31-7 (U5MK0034, 3637428M91)	30/32-7 (68504, 3639048M1)		30/34-7 (41158057, 745818M91)	30/35-7 (31358345, 739043M1)	30/36-7 (31358323, 734179M1)
50, 50B, 3303, 3305 <i>(Rope seal / Retén de cuerdas) 3 ring piston / 3 segmentos</i>	A4.212	30/31-10 (B1102)	30/32-10 (68515)	30/33-10 (89206, 740082M91)	30/34-10 (41158045, 745764M91)	30/35-14 (31358394, 744948M1)	30/36-14 (31358393, 744131M1)
50, 50B, 3303, 3305 <i>(Lip seal / Retén de labios) 4 ring piston / 4 segmentos</i>	A4.212	30/31-9 (U5MK0066, 3637432M91)	30/32-9 (68514, 1896435M91)	30/33-9 (86721, 738249M91)	30/34-9 (41158044, 745763M91)		

(A) Untopped piston available 30/33-5 equivalent to 68306, 743121M91.

Pistón para rectificar altura disponible, 30/33-5 equivalente a 68306, 743121M91

(H) 30/34-71 is required for piston U5LP0017, 3637513M91 that fitted: 30/34-71 se usa para pistón U5P0017, 3637513M91 montado en: 164T, 253

(UK) (CN31219), 263T (Italy), 264T, 355 & 360 (CN31187).

Piston / Pistón U5LP0017, 3637513M91 is replaced by / está sustituido por 30/33-72 + 30/34-72

Part numbers are quoted for reference purposes only.

Our parts and accessories are not original.

Las referencias originales tienen un propósito identificativo.

Nuestras piezas no son originales.



PISTONS, RING SETS & LINERS
PISTONES, JUEGOS DE SEGMENTOS & CAMISAS



Tractors Tractores	Engine Motor	1 Kit set Juego	2 Piston & rings Pistón con aros	3 Piston & pin Pistón sin aros	4 Ring set Juego de segm.	5 Finished liner Camisa term.	6 Semi-finished liner Camisa semi-term.
4 cylinder engine industrial tractors / Palas retrocargadoras motores 4 cilindros							
30D, 50, 50B, 50B MKII, 50C, 50D, 50E, 50H, 60 Early blocks 103.19mm bore Ø Primeros bloques 103.19mm Ø	A4.236	30/31-14 (U5MK0171, 3638888M91)				30/35-14 (31358394, 744948M1)	30/36-14 (31358393, 744131M1)
30D, 50, 50B, 50B MKII, 50C, 50D, 50E, 50H, 60 Later blocks 104.20mm bore Ø Últimos bloques 104.20mm Ø	A4.236	30/31-69 (U5MK0286)	30/32-69 (68516, 3639051M1)	30/33-69 (68301, U5LP0035, 743110M91, 3637516M91)	30/34-12 (41158041, 745760M91)	30/35-22 (3135X032, 3637332M1)	30/36-22 (3135X031, 3637331M1)
50H-S, 50H-T	A4.236						
60HX, 60HX-T	AT4.236	30/31-74 (U5MK0169)	30/32-74 (U5PR0025, 3639514M1)	30/33-74 (U5LP0022, 3637360M91)	30/34-74 (4181A022, 3638721M91)		
50EX, 50HX, 60H With flame ring Con segmentos cortafuegos	A4.248	30/31-57 (B1126)				30/35-15 (31358352, 742466M1)	30/36-15 (31358346, 740571M1)
50EX, 50HX, 60H 50HX-S, 50HX-T, 60H-S Without flame ring Sin segmentos cortafuegos	A4.248	30/31-58 (B3158)	30/32-57 (B1226)	30/33-57 (U5LP0009, 747050M91)	30/34-57 (41158022, 747428M91)	30/35-23 (3135X034, 3637334M1)	30/36-23 (3135X033, 3637333M1)
70	A4.318	30/31-21 (B1111)	30/32-21 (B1211)	30/33-21 (86716, 738106M91)	30/34-21 (41158118, 745950M91)	30/35-21 (31358534, 745991M1)	30/36-21 (31358533, 745990M1)
Ferret & Terex - 4 cylinder engine industrial tractors / Palas retrocargadoras motores 4 cilindros							
750	1004.4 (Blue)	30/31-176 (B31176)	30/32-176 (B32176)	30/33-176 (U5LL0021, 3641806M91)	30/34-110 (E) (4181A019, 3637033M91) 30/34-176 (E) (4181A041, 4222706M91)	30/35-108 (3135X042, 748216M1)	30/36-108 (3135X041, 748215M1)
750, 750B	1004.42 (Green)		30/32-182 (B32182)	30/33-182 (U5LP0058, 4222949M91)	30/34-182 (4181A045, 4222950M91)		
760, 860, 860S, 860SE, 865, 960, 965	1004.4T (Blue)	30/31-108 (U5MK0275, 3640333M91)	30/32-108 (U5PR0040, 3640334M91)	30/33-108 (U5LL0014, 3640593M91)	30/34-90 (D) (4181A021, 3637032M91) 30/34-108 (D) (4181A026, 3641316M91)	30/35-108 (3135X042, 748216M1)	30/36-108 (3135X041, 748215M1)
760, 760B, 860, 860B, 860S, 860SE, 960, 960B, 965	1004.40T (Green)	30/31-173 (B31173)	30/32-173 (U5PR0054)	30/33-173 (U5LP0057, 4222134M91)	30/34-173 (4181A033, 4222136M91)	30/35-173 (3135X062, 4222128M1)	30/36-173 (3135X063, 4222129M1)

(D) 30/34-90 is required for piston U5LL0013, 3638796M91 that fitted early versions. Piston U5LL0013, 3638796M91 is replaced by 30/33-108+30/34-108
30/34-90 se usa para pistón U5LL0013, 3638796M91 (Primeras versiones). El pistón U5LL0013, 3638796M91 está sustituido por 30/33-108+30/34-108
(E) 30/34-110 is required for piston U5LL0017, 3641024M91 that fitted early versions. Piston U5LL0017, 3641024M91 is replaced by 30/33-176+30/34-176
30/34-110 se usa para pistón U5LL0017, 3641024M91 (Primeras versiones). El pistón U5LL0017, 3641024M91 está sustituido por 30/33-176+30/34-176

Part numbers are quoted for reference purposes only.
Our parts and accessories are not original.

Las referencias originales tienen un propósito identificativo.
Nuestras piezas no son originales.



SEMI-FINISHED KIT SETS
EQUIPOS DE CILINDRO CON CAMISAS SEMI-TERMINADAS

The following are kit sets with semi-finished liners that are stocked in addition to fully finished kit sets shown in the main section. Specific tractor and combine applications may be determined by referring to the fully finished kit set numbers in the main section. Los siguientes juegos de cilindro con camisas semi-terminadas están disponibles además de los juegos de cilindro con camisas terminadas mostrados en la sección principal. Las aplicaciones específicas sobre tractor y cosechadora pueden determinarse por la correspondencia con los números de los juegos de cilindro con camisas terminadas de la sección principal.



Engine Motor	Ref. Fully finished kit set Juego con cam. term.	1 Semi-finished kit set Juego con camisas semi-terminada	2 Piston & pin Pistón sin segm.	3 Ring set Juego de segm.	4 Semi-finished liner Camisa semi-terminada
A3.144 A4.192 A6.305	30/31-3	30/31-3S (U5MK0056, 3639469M91)	30/33-3 (55274, 739845M91)	30/34-3 (41158063, 745823M91)	30/36-3 (0530002, 731595M1)
A3.152 A4.203	30/31-5	30/31-5S (U5MK0058, 3640485M91)	30/33-4 (81512, 734460M91)	30/34-7 (41158057, 745818M91)	30/36-7 (31358323, 734179M1)
AD3.152 AD4.203 5 ring piston / Pistón 5 segmentos	30/31-7	30/31-7S (U5MK0035, 3639467M1)	30/33-7 (68332, 743824M91)	30/34-8 (41158065, 745826M91)	30/36-14 (31358393, 744131M1)
AD3.152 AD4.203 4 ring piston / Pistón 4 segmentos	30/31-8	30/31-8S (U5MK0059, 3637765M91)	30/33-8 (89214, 742621M91)	30/34-9 (41158044, 745763M91)	30/36-22 (31355X031, 3637331M1)
A4.212	30/31-9	30/31-9S (B3109S)	30/33-9 (86721, 738249M91)	30/34-12 (41158041, 745760M91)	30/36-15 (31358346, 740571M1)
A4.236 Early blocks 103.19mm bore Ø Liner with flame ring Primeros bloques 103.19mm Ø Camisa con cortafuegos	30/31-14	30/31-14S (B3114S)	30/33-69 (68301, U5LP0035, 743110M91, 3637516M91)	30/34-13 (4181A009, 747041M91)	30/36-23 (31355X033, 3637333M1)
A4.236 Later blocks 104.20mm bore Ø Liner without flame ring Últimos bloques 104.20mm Ø Camisa sin cortafuegos	30/31-69	30/31-69S (B3169S)	30/33-74 (U5LP0022, 3637360M91)	30/34-13 (4181A009, 747041M91)	
AT4.236 Later blocks 104.20mm bore Ø Liner without flame ring Últimos bloques 104.20mm Ø Camisa sin cortafuegos	30/31-74	30/31-74S (U5MK0170)	30/33-13 (89207, 740821M91)	30/34-57 (41158022, 747428M91)	
A4.248 (⇔ U839079J) 4 ring piston / Pistón 4 segmentos Liner with flame ring Camisa con cortafuegos	30/31-15	30/31-15S (U5MK0124, 3638884M91)	30/33-57 (U5LP0009, 747050M91)	30/34-183 (4115Y001, 4222053M91)	
A4.248 (U839080J ⇔) 3 ring piston / Pistón 3 segmentos	30/31-57	30/31-57S (B3157S)	30/33-183 (U5LL0031, 4223499M91)		
A4.248 Liner without flame ring Camisa sin cortafuegos	30/31-58	30/31-58S (B3158S)			
A4.41	30/31-183	30/31-183S (B31183S)			

Part numbers are quoted for reference purposes only.
Our parts and accessories are not original.

Las referencias originales tienen un propósito identificativo.
Nuestras piezas no son originales.



SEMI-FINISHED KIT SETS
EQUIPOS DE CILINDRO CON CAMISAS SEMI-TERMINADAS

The following are kit sets with semi-finished liners that are stocked in addition to fully finished kit sets shown in the main section. Specific tractor and combine applications may be determined by referring to the fully finished kit set numbers in the main section. *Los siguientes juegos de cilindro con camisas semi-terminadas están disponibles además de los juegos de cilindro con camisas terminadas mostrados en la sección principal. Las aplicaciones específicas sobre tractor y cosechadora pueden determinarse por la correspondencia con los números de los juegos de cilindro con camisas terminadas de la sección principal.*



Engine Motor	Ref.	1	2	3	4
	Fully finished kit set <i>Juego con cam. term.</i>	Semi-finished kit set <i>Juego con camisas semi-terminada</i>	Piston & pin <i>Pistón sin segm.</i>	Ring set <i>Juego de segm.</i>	Semi-finished liner <i>Camisa semi-terminada</i>
A6.354 A6.354.1 A6.354.4 <i>5 ring piston / Pistón 5 segmentos</i>	30/31-70	30/31-70S (U5MEK0128, 3638886M91)	30/33-18 (86740, 738871M91)	30/34-12 (41158041, 745760M91)	30/36-14 (31358393, 744131M1)
A6.354.1 A6.354.2 <i>5 ring Al-fin piston, Parallel liner Pistón 5 segmentos Al-fin Camisa cilíndrica</i>		30/31-79S (U5MEK0068, 3641222M91)	30/33-24 (86745, 3637280M91)	30/34-24 (41158032, 745752M91)	30/36-18 (31358324, 734644M1)
A6.354.4 <i>3 ring Al-fin piston Pistón 3 segmentos Al-fin</i>	30/31-77	30/31-77S (U5MEK0130, 3641223M91)	30/33-77 (U5LP0021, 748266M91)	30/34-75 (41158017, 745738M91)	30/36-14 (31358393, 744131M1)
AT6.354.4	30/31-78	30/31-78S (U5MEK0131, 3638887M91)	30/33-78 (68803, 745379M91)	30/34-78 (41158005, 745277M91)	
1004.4 (Blue) 1006.6 (Blue)	30/31-176	30/31-176S (B31176S)	30/33-176 (U5LL0021, 3641806M91)	30/34-176 (4181A041, 4222706M91)	30/36-108 (3135X041, 748215M1)
1004.4T (Blue) 1006.6T (Blue)	30/31-108	30/31-108S (B31108S)	30/33-108 (U5LL0014, 3640593M91)	30/34-108 (4181A026, 3641316M91)	
1004.40 (Green) 1004.40T (Green) 1006.60 (Green) 1006.60T (Green)	30/31-173	30/31-173S (B31173S)	30/33-173 (U5LP0057, 4222134M91)	30/34-173 (4181A033, 4222136M91)	30/36-173 (3135X063, 4222129M1)

Part numbers are quoted for reference purposes only.
Our parts and accessories are not original.

*Las referencias originales tienen un propósito identificativo.
Nuestras piezas no son originales.*



PISTONS, RING SETS & LINERS (OVERSIZE)
PISTONES, JUEGOS DE SEGMENTOS & CAMISAS (SOBREMEDIDAS)

Specific tractor & combine applications may be determined by referring to the standard size numbers in the main section.
La aplicación específica sobre tractor y cosechadora puede ser determinada por referencia a los números de medida estándar en la sección principal.

Engine Motor	Standard size Dimensión Est.	+ 0.25mm + 0.010"	+ 0.76mm + 0.030"	+ 1.27mm + 0.050"	+ 2.54mm + 0.100"
Pistons & rings / Pistones & segmentos					
A4.236 <i>Ropo val / Retón de cuercas</i>	30/32-12 (68506, 3640442M91)		30/32-12C (68506C)		
A6.354, A6.354.1, A6.354.4 <i>(Early models / Primeros modelos)</i> <i>5 ring dualflex / 5 segmentos dualflex</i>	30/32-18 (68510)		30/32-18C (68510C)		
A6.354, A6.354.1, A6.354.4 <i>(Early models / Primeros modelos)</i> <i>5 ring standard / 5 segmentos estándar</i>	30/32-22 (68509, 3641196M91)		30/32-22C (68509C)		
Pistons / Pistones					
A4.236 <i>Ropo val / Retón de cuercas</i>	30/33-12 (82878, 735187M91)		30/33-12C (82878C, 3640444M91)		
A6.354, A6.354.1, A6.354.4 <i>(Early models / Primeros modelos)</i>	30/33-18 (86740, 738871M91)		30/33-18C (86740C, 738872M91)		
Rings / Segmentos					
A4.236 A6.354, A6.354.2 <i>(Early models / Primeros modelos)</i> <i>5 ring standard / 5 segmentos estándar</i>	30/34-12 (41158041, 745760M91)		30/34-12C (41158041C, 745766M91)		
A6.354, A6.354.1, A6.354.4 <i>(Early models / Primeros modelos)</i> <i>5 ring dualflex / 5 segmentos dualflex</i>	30/34-18 (41158029, 745750M91)		30/34-18C (41158029C, 3640234M1)		
A6.354.1, A6.354.4	30/34-24 (41158032, 745752M91)	30/34-24A (41158032A)			
Semi-finished liners / Camisas semi-terminadas					
A3.152, AD3.152, AG3.152, AT3.152.4, A4.203, AD4.203	30/36-7 (31358323, 734179M1)	30/36-7A (31358384, 745243M1)	30/36-7C (31358357, 3637494M1)	30/36-7E (31358323E)	30/36-7K (31358323K)

CYLINDER LINER SHIMS
CALAS DE CAMISA

A3.152, AD3.152, AG3.152, AT3.154, A4.203, AD4.203

30/51-11
(33127107, 735227M1)

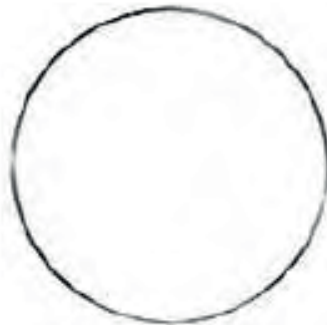

Part numbers are quoted for reference purposes only.
Our parts and accessories are not original.

*Las referencias originales tienen un propósito identificativo.
Nuestras piezas no son originales.*



**PISTONS
PISTONES**

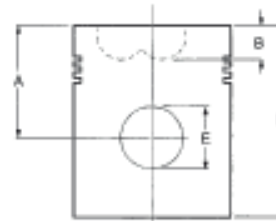
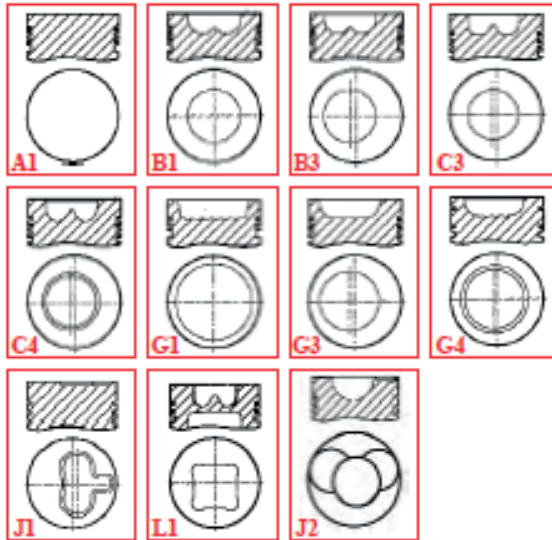

- A : Compression height (mm)
Altura de compresión (mm)
- B : Combustion bowl depth (mm)
Profundidad cámara de combustión (mm)
- D : Overall length (mm)
Largo total (mm)
- E : Gudgeon pin diameter (mm)
Diámetro bulón (mm)

Ref. Ref.	Type Tipo	Bore Ø Dia. Ø	Rings Segm.	Al-fin Al-fin	A (mm)	B (mm)	D (mm)	E (mm)
30/33-1	A1	80.96	5	n	60.70	-	99.00	25.40
30/33-2	J1	84.14	5	n	60.20	3.18	98.26	28.57
30/33-3	A1	88.92	5	n	57.30	-	108.10	31.75
30/33-4	A1	91.49	5	n	56.92	-	107.70	31.75
30/33-5	A1	91.49	5	n	57.33	-	108.13	31.75
30/33-7	B3	91.49	5	n	61.77	18.17	109.37	31.75
30/33-8	G3	91.49	4	n	61.63	18.70	109.25	31.75
30/33-9	G3	98.48	4	n	76.53	19.04	127.28	34.92
30/33-10	G3	98.48	3	n	76.53	19.57	116.13	34.92
30/33-11	G1	91.49	3	n	55.50	20.00	102.44	31.75
30/33-12	G3	98.48	5	n	69.92	20.15	120.65	34.92
30/33-13	G3	101.05	4	n	69.92	20.56	120.69	34.92
30/33-16	A1	79.38	5	n	45.72	-	79.86	23.81
30/33-18	C3	98.48	5	n	69.91	25.61	120.71	34.92
30/33-20	B3	107.95	5	n	73.88	22.12	124.65	36.51
30/33-21	B3	114.31	4	n	70.68	24.08	124.61	36.51
30/33-23	B1	98.48	4	n	69.65	19.08	120.42	38.10
30/33-24	C3	98.48	5	y	69.83	25.21	120.68	34.92
30/33-40	A1	85.00	5	n	51.05	-	87.58	22.22
30/33-41	A1	87.00	4	n	50.99	-	87.52	22.22

Ref. Ref.	Type Tipo	Bore Ø Dia. Ø	Rings Segm.	Al-fin Al-fin	A (mm)	B (mm)	D (mm)	E (mm)
30/33-57	G3	101.05	3	n	69.90	20.65	120.70	34.92
30/33-59	B3	114.31	3	y	70.68	24.08	124.61	36.51
30/33-69	G3	98.48	5	n	70.35	20.20	120.70	34.92
30/33-72	G4	91.49	3	y	61.63	18.63	108.79	31.75
30/33-73	G3	100.00	3	n	70.09	22.44	108.25	37.51
30/33-74	G4	98.48	3	y	70.25	20.35	108.25	38.10
30/33-77	C4	98.48	3	y	69.80	23.87	120.60	34.92
30/33-78	B3	98.48	3	y	69.75	18.67	107.85	38.10
30/33-108	L1	100.00	3	y	70.02	19.48	108.06	38.00
30/33-109	L1	100.00	3	y	70.02	20.14	108.14	34.90
30/33-173	C4	100.00	3	y	70.32	21.50	108.26	36.69
30/33-174	J2	107.90	3	y	70.48	18.72	106.68	40.00
30/33-176	L1	100.00	3	y	70.02	20.14	108.14	34.90
30/33-177	C4	94.30	3	n	63.36	20.45	99.76	31.72
30/33-178	C4	94.31	3	y	63.02	21.00	99.65	31.80
30/33-179	L1	100.00	3	y	70.00	19.62	108.20	38.06
30/33-182	J2	102.38	3	n	70.32	22.22	108.38	39.68
30/33-183	G3	100.00	3	n	71.70	20.41	100.36	34.91

Part numbers are quoted for reference purposes only.
Our parts and accessories are not original.

Las referencias originales tienen un propósito identificativo.
Nuestras piezas no son originales.



**LINERS
CAMISAS**

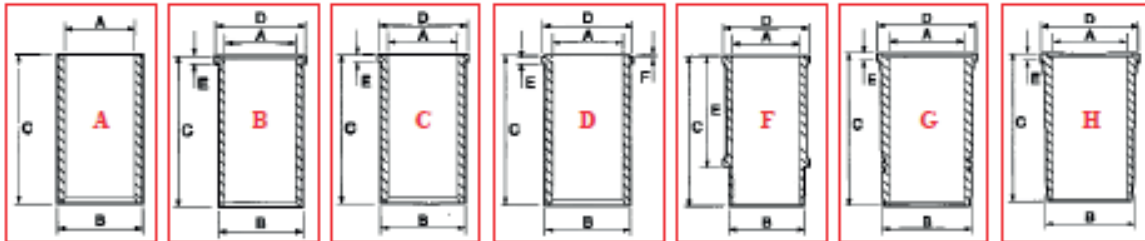

A : Nominal bore diameter (mm) / *Díámetro interior (mm)* D : Flange diameter (mm) / *Grueso de pestaña (mm)*
 B : Outside diameter (mm) / *Díámetro exterior (mm)* E : Fin height (mm) / *Altura del cortafuegos (mm)*
 C : Overall length (mm) / *Largo total (mm)*

Fully-finished liners / Camisas terminadas

Ref. Ref.	Type Tipo	A (mm)	B (mm)	C (mm)	D (mm)	E (mm)	F (mm)
30/35-1	B	80.96	86.51	169.93	92.71	5.48	-
30/35-2	D	84.14	89.72	187.96	94.29	11.18	0.64
30/35-3	C	88.92	93.71	216.03	94.41	4.76	-
30/35-4	C	91.49	93.68	215.90	96.77	1.14	-
30/35-7	C	91.49	93.66	216.03	96.72	3.81	-
30/35-14	D	98.48	103.19	227.28	106.45	3.86	0.89
30/35-15	D	101.05	104.20	227.28	107.44	3.86	0.84
30/35-16	H	79.38	85.67	163.53	93.7	6.40	-
30/35-20	G	107.95	120.50	229.00	128.44	9.55	-
30/35-21	C	114.31	117.88	230.78	121.13	2.72	-
30/35-22	C	98.48	104.20	226.44	107.37	3.81	-
30/35-23	C	101.05	104.20	226.44	107.37	3.81	-
30/35-40	F	85.00	92.02	171.45	104.39	114.00	-
30/35-41	F	87.00	92.84	171.45	104.20	114.00	-
30/35-108	C	100.00	104.33	226.44	107.44	3.86	-
30/35-173	C	100.00	104.11	228.00	107.34	3.90	0.89
30/35-174	G	107.80	117.08	218.00	131.72	9.06	0.98

Semi-finished liners / Camisas semi-terminadas

Ref. Ref.	Type Tipo	A (mm)	B (mm)	C (mm)	D (mm)	E (mm)	F (mm)
30/36-3	C	88.92	93.71	216.03	94.41	4.76	-
30/36-7	C	91.49	93.71	216.03	96.72	3.81	-
30/36-13	A	101.05	103.26	223.90	-	-	-
30/36-14	D	98.48	103.24	227.28	106.23	3.86	0.89
30/36-15	D	101.05	104.25	227.28	107.44	3.86	0.76
30/36-18	A	98.48	103.26	228.98	-	-	-
30/36-21	C	114.31	117.93	230.78	121.13	2.72	-
30/36-22	C	98.48	104.20	226.44	107.37	3.81	-
30/36-23	C	101.05	104.20	226.44	107.37	3.81	-
30/36-24	A	91.49	93.76	215.90	-	-	-
30/36-108	C	100.00	104.33	226.44	107.44	3.86	-
30/36-173	C	99.08	104.11	228.00	107.34	3.91	0.98
30/36-177	A	93.55	96.70	215.00	-	-	-

Part numbers are quoted for reference purposes only.
 Our parts and accessories are not original.

Las referencias originales tienen un propósito identificativo.
 Nuestras piezas no son originales.



RING SETS
JUEGOS DE SEGMENTOS

Ref. Ref.	Bore Ø Diz. Ø															
30/34-1	80.96	CP1		2.00	P1		2.00	P1		2.00	DX		3.97	SS		3.97
30/34-2	84.14	CP1		2.38	P2		2.38	P2		2.38	SS		4.76	SS		4.76
30/34-3	88.92	CP1		2.38	P1		2.38	LS		3.17	DX		6.35	SS		6.35
30/34-4	91.49	P1		2.38	T1		2.38	LS		3.17	SS		6.35	SS		6.35
30/34-7	91.49	CP1		2.38	P1		2.38	LS		3.17	DX		6.35	SS		6.35
30/34-8	91.49	CP1		2.38	P2		2.38	P2		2.38	CHH		4.76			
30/34-9	98.48	CP1		2.38	P1		2.38	P2		2.38	CHH		6.35			
30/34-10	98.48	CP1		2.38	CP2		2.38	CHH		6.35						
30/34-11	91.49	CP1		2.38	P2		2.38	CHH		6.35						
30/34-12	98.48	CP1		2.38	P2		2.38	P2		2.38	CHH		6.35	SS		6.35
30/34-12T	98.48	CR1		2.38	P2		2.38	P2		2.38	SS		6.35	SS		6.35
30/34-13	101.05	CT1		2.38	CP3		2.38	CP3		2.38	CHH		6.35			
30/34-16	79.38	P1		1.98	P2		1.59	P2		1.59	DX		4.76	SS		4.76
30/34-18	98.48	E1		2.38	P2		2.38	P2		2.38	DX		6.35	SS		6.35
30/34-20	107.95	CP1		3.17	P1		3.17	P1		3.17	SS		6.35	SS		6.35
30/34-21	114.31	CP1		2.38	P2		2.38	P2		2.38	CHH		6.35			
30/34-23	98.48	CP1		3.17	CP3		2.38	CP3		2.38	CHH		6.35			
30/34-24	98.48	CP1		3.17	CP3		2.38	CP3		2.38	CHH		6.35	SS		6.35
30/34-40	85.00	P1		2.00	P1		2.00	P1		2.00	SS		4.76	SS		3.97
30/34-41	87.00	P1		2.00	P1		2.00	SS		4.76	SS		4.76			
30/34-57	101.05	MR2		2.50	CT2		2.50	CHH		5.00						
30/34-59	114.31	CT1		2.38	CTN1		2.38	CHH		6.35						
30/34-71	91.49	CT1		2.38	T1		2.38	CHH		4.76						
30/34-72	91.48	CK1		3.00	CT1		2.38	CHH		3.50						
30/34-74	98.48	MK1		3.17	CT1		2.38	CHH		4.76						
30/34-75	98.48	CR3		2.38	CT1		2.38	CHH		4.76						
30/34-78	98.48	MK1		3.17	T1		2.38	CHH		4.76						

Part numbers are quoted for reference purposes only.
Our parts and accessories are not original.

Las referencias originales tienen un propósito identificativo.
Nuestras piezas no son originales.



RING SETS
JUEGOS DE SEGMENTOS

Ref. Ref.	Bore Ø Dia. Ø						
30/34-90	100.00	CK1	 3.00	T1	 2.50	CBEH	 4.00
30/34-108	100.00	CK2	 3.50	TN1	 4.00	CBEH	 4.00
30/34-110	100.00	CR3	 2.50	T1	 2.50	CBEH	 4.00
30/34-173	100.00	CK1	 3.50	TN1	 2.50	CBEH	 3.50
30/34-174	108.00	CK1	 3.00	P1	 2.50	CBEH	 4.00
30/34-175	108.00	CP1	 2.50	P1	 3.00	CBEH	 5.00
30/34-176	100.00	CR3	 2.50	T1	 2.50	CBEH	 4.00
30/34-177	95.00	CK1	 3.00	T5	 2.00	CBEH	 4.00
30/34-178	95.00	CT1	 2.50	T5	 2.00	CBEH	 4.00
30/34-182	103.00	CR1	 2.50	TN1	 2.50	CBEH	 3.50
30/34-183	101.05	MR2	 2.50	CT2	 2.50	CBEH	 5.00

CBEH : Chrome plated bevelled edge with helical coil spring / Cromado y rebajado con muelle helicoidal

CK1 : Chrome plated keystone / Trapezoidal dos caras (cromado exterior)

CK2 : Chrome plated keystone ID step / Trapezoidal dos caras con escalón interior

CP1 : Chrome plated parallel faced / Rectangular cromado

CP2 : Chrome plated parallel faced internally stepped top / Rectangular cromado con escalón interior / superior

CP3 : Chrome plated parallel faced internally bevelled top / Rectangular cromado con bisel interior / superior

CR1 : Chrome plated barrel faced / Cara exterior cromada y abombada

CR3 : Chrome plated barrel faced internally bevelled top / Exterior abombado y cromado, rebaje interior alto.

CT1 : Chrome plated taper faced / Exterior cromado y cónico

CT2 : Chrome plated taper faced internally stepped top / Exterior cónico cromado con rebaje interior superior

CTN1 : Chrome plated taper faced napier / Tipo Napier o "pico de aguja" cónico cromado

DX : Duaflex with chrome plated segments / Duaflex

E1 : Externally stepped top / Rectangular con rebaje exterior alto

GX : Oilmaster with chrome plated segments / Control de aceite

LS : Laminated steel segments / Segmentos de acero laminado

MK1 : Molybdenum coated keystone / Trapezoidal ambos lados con recubrimiento de Molibdeno en cara exterior

MR2 : Molybdenum plated barrel faced internally stepped top / Exterior abombado al molibdeno, rebaje interior alto

P1 : Parallel faced plain Rectangulaire / Rectangular

P2 : Parallel faced internally stepped top / Rectangular con escalón interior superior

SS : Standard slotted / Normal

T1 : Taper faced plain / Exteriormente cónico

T5 : Taper component / Exteriormente cónico con escalón

TN1 : Taper faced napier / Tipo Napier o "pico de aguja" cónico

Part numbers are quoted for reference purposes only.
Our parts and accessories are not original.

Las referencias originales tienen un propósito identificativo.
Nuestros piezas no son originales.



VALVETRAIN KITS
JUEGOS DE REPARACIÓN DE VÁLVULAS

Contents : Inlet & exhaust valves
Inlet & exhaust guides
Valve springs
Caps, cottars & washers

Se incluye : Válvulas admisión y escape
Guías admisión y escape
Muelles de válvula
Tapones, semiconos y arandelas



Engines Motores	Valve train kit juego de válvulas
A3.144 A3.152	30/39-2 (U5VK0131, 4224156M91)
AD3.152 (⇒U584638F) Valve angle 45°Ángulo de válvula	30/39-3 (U5VK0141, 4224157M91)
AD3.152 (U584639F ⇒) Valve angle 35°Ángulo de válvula	30/39-4 (U5VK0111, 4224154M91)
AT3.152.4	30/39-5 (U5VK0121, 4224155M91)
A4.192 A4.203	30/39-8 (U5VK0130+U5VK0131)
AD4.203 (⇒U546167F) Valve angle 45°Ángulo de válvula	30/39-9 (U5VK0140+U5VK0141)
AD4.203 (U546168F ⇒) Valve angle 35°Ángulo de válvula	30/39-44 (U5VK0120+U5VK0121)
A4.212, A4.236, A4.248 <i>(Low rated / Especificación estándar)</i>	30/39-12 (U5VK0151, 4224158M91)
A4.212, A4.236, A4.248 <i>(High rated / Especificación superior)</i>	30/39-15 (U5VK0161, 4224159M91)
AT4.236	30/39-13 (U5VK0171, 4224160M91)
A4.318 A4.318.2	30/39-16 (A) (B3916)
A6.354.4 AT6.354.4 A6.372.4	30/39-18 (U5VK0201, 4224165M91)
A4.41, 1004.4 (Blue), 1004.4T (Blue) Valve angle 45°Ángulo de válvula	30/39-40 (U5VK0181, 4224161M91)
1004.4 (Blue), 1004.4T (Blue) Valve angle 30°Ángulo de válvula	30/39-41 (U5VK0191, 4224163M91)
1006.6 (Blue), 1006.6T (Blue) Valve angle 45°Ángulo de válvula	30/39-42 (U5VK0182, 4224162M91)
1006.6 (Blue), 1006.6T (Blue) Valve angle 30°Ángulo de válvula	30/39-43 (U5VK0192, 4224164M91)

(A) Kit does not include caps and washers

(A) Este juego no incluye tapones y arandelas



The components within these kits should not be mixed with older components.
These kits are stock items. We are happy to make up kits to your requirements.
Los componentes de estos juegos no deben ser mezclados en el montaje con otros viejos.
Estos juegos se almacenan para servicio. Nos complacerá preparar un juego según sus necesidades.

Part numbers are quoted for reference purposes only.
Our parts and accessories are not original.

Las referencias originales tienen un propósito identificativo.
Nuestras piezas no son originales.



CYLINDER HEAD PARTS
CULATAS Y PIEZAS ANEXAS



		1	2	3	4	5
Tractors Tractores	Engine Motor	Cyl. Head Assy. Culata armada	Inlet guide Guía admis.	Exhaust guide Guía escape	Inlet valve Válvula admis.	Exhaust valve Válvula escape
3 cylinder engines / Motores 3 cilindros						
35	A3.144	30/40-1 (ZZ80048, 3638321M91)	30/41-3 (3316A031, 4223519M1)	30/42-3 (31431261, 731151M1)	30/43-3 (0910002, 731152M1)	
	A3.152					
133, 135	A3.144					
135	AG3.152		30/41-19 (3313E734, 4223455M1)	30/42-27 (31431741, 739641M1)	30/43-27 (31431731, 739439M1)	
133, 134, 135, 140, 145, 235, 240, 245 (U584639F) Válv. angle 45°/Ángulo de válvula	AD3.152 Cyl. head / Culata 86550 & 68128	30/40-3 (ZZ80082, ZZ80235, 3637389M91, 4222810M91)	30/41-3 (3316A031, 4223519M1)	30/42-4 (31431281, 732811M1)	30/43-4 (31431591, 737640M1)	
133, 134, 135, 140, 145, 235, 240, 245 (U584639F) Válv. angle 35°/Ángulo de válvula	AD3.152 Cyl. head / Culata 89141 ⇒ ZZ80082					30/42-5 (31431681, 739060M1)
148, 150, 152, 154, 230, 233, 234, 244CF, 250, 253 (Italy), 254, 255, 333, 334V, 340, 342, 350, 353, 354, 356CF, 550, 2205, 3210	AD3.152 Cyl. head / Culata ZZ80235		30/41-3 (3316A031, 4223519M1)	30/41-19 (3313E734, 4223455M1)	30/43-24 (31431031, 3637616M1)	
164T, 263T (Italy), 264T 355, 360 (CN31187)	AT3.152.4		30/41-20 (U3316A032, 4223487M1)	30/41-3 (3316A031, 4223519M1)	30/42-24 (31431981, 745534M1)	30/43-5 (31431011, 747581M1)
253 (UK) 352, 355 (CN31256)	AT3.152.4 Cyl. head / Culata ZZ80139			30/41-19 (3313E734, 4223455M1)		30/43-24 (31431031, 3637616M1)
253 (UK), 264TCF 352, 355 (CN31256) 360 (CN31185) 363, 364, 366CF	AT3.152.4 Cyl. head / Culata ZZ80113			30/41-19 (3313E734, 4223455M1)	30/42-26 (31431121, 3637528M1)	30/43-5 (3142A081, 3637529M1)
2210, 3315, 4215, 4315	903.27					
263 (UK), 2220, 3325, 4220, 4320	903.27T		30/41-60 (U3316A013, 4222938M1)	30/42-60 (3142H042, 4222579M1)	30/43-60 (3142A091, 4222580M1)	

Part numbers are quoted for reference purposes only.
Our parts and accessories are not original.

Las referencias originales tienen un propósito identificativo.
Nuestras piezas no son originales.



CYLINDER HEAD PARTS CULATAS Y PIEZAS ANEXAS



Tractors Tractores	Engine Motor	1 Cyl. Head Assy. Culata armada	2 Inlet guide Guía admis.	3 Exhaust guide Guía escape	4 Inlet valve Válvula admis.	5 Exhaust valve Válvula escape
4 cylinder engines / Motores 4 cilindros						
TEA20 TED20 TEH20	85mm Petrol 85mm VO 85mm LO		30/41-1 (825259M1)		30/42-19 (101871)	30/43-19 (100652)
TEF 20	20C Diesel		30/41-1 (825259M1)	30/41-10 (105138)	30/42-1 (101661)	30/43-1 (110926)
FE35, 835	23C Diesel			30/41-2 (826162M1)	30/42-2 (1884123M1)	30/43-2 (1884124M1)
35, 135	87mm Petrol				30/42-20 (826244M1)	30/43-20 (826245M1)
25, 122	A4.99		30/41-9 (3313E735, 4223964M1)	30/41-3 (3316A031, 4223519M1)	30/42-15 (0910060, 36392383M1)	30/43-15 (0910061, 3639239M1)
25, 30, 130, 825	A4.107					
65	A4.192	30/40-4 (ZZ80089, 3637485M91)	30/41-3 (3316A031, 4223519M1)		30/42-3 (31431261, 731151M1)	30/43-3 (0910002, 731152M1)
65, 865	A4.203				30/42-4 (31431281, 732811M1)	30/43-4 (31431391, 737640M1)
65, 155, 158, 165, 765 260, 560 (⇒ U546167F) Válvulo ángulo 45° Ángulo de válvulo	AD4.203	⇒ U527443E 30/40-5 (ZZ80033, 3637384M91)				
158 MKIII 260, 560 (U546168F ⇒) Válvulo ángulo 35° Ángulo de válvulo	AD4.203		30/41-20 (U3316A032, 4223487M1)	30/41-3 (3316A031, 4223519M1)	30/42-5 (31431681, 739060M1)	30/43-5 (31431011, 747581M1)
165, 174	A4.212				(A) Low rated Especif. estan. 30/42-6 (31431641, 739027M1)	(A) Low rated Especif. estan. 30/43-6 (31431881, 741466M1)
168, 168MKIII, 174, 175, 184, 255 (USA), 265, 273, 274, 275, 275E, 283, 284, 362, 362N, 365, 367CF, 372N, 373, 374, 375, 375E, 376C, 377, 383, 384, 387, 565, 575, 675, 3050, 3220, 3225	A4.236	30/40-6 (ZZ80175, 3640877M91)	30/41-17 (A) (3343F041, 4223073M1)	30/41-18 (A) (3343J021, 4223074M1)		
178, 185, 188, 194, 285, 290, 290E, 293, 294, 382N, 390, 390E, 393, 394, 396C, 397, 590, 690, 3055, 3060, 3235	A4.248					
390T, 393TLX, 394TAQ, 396CT, 397T, 398, 698T, 1004T, 1007, 3065, 3065S, 3070	AT4.236				30/42-25 (3142H002, 746823M1)	30/43-9 (3142A052, 747552M1)

(A) Oversize valves are available for cyl. head Assy. (⇒1985) which were not fitted with valve guides. See Page MF-77 for details.
Las válvulas a sobremedida están disponibles para culatas (⇒1985) sin guías de válvulo montadas. Ver página MF-77 para detalles.

Part numbers are quoted for reference purposes only.
Our parts and accessories are not original.

Las referencias originales tienen un propósito identificativo.
Nuestras piezas no son originales.



CYLINDER HEAD PARTS CULATAS Y PIEZAS ANEXAS



Tractors <i>Tractores</i>	Engine <i>Motor</i>	2 Inlet guide <i>Guía adms.</i>	3 Exhaust guide <i>Guía escape</i>	4 Inlet valve <i>Válvula adms.</i>	5 Exhaust valve <i>Válvula escape</i>
4 cylinder engines / Motores 4 cilindros					
285 (USA), 592, 595, 1080, 1085	A4.318	30/41-8 (33432532, 738094M1)		30/42-16 (31431154, 738095M1)	30/43-16 (31431671, 738944M1)
285 (USA), 298, 592, 595, 698, 1004	A4.318.2				
275E, 290E, 375E, 390E, 4225, 4235, 4240, 6110, 6120	A4.41 (Blue)	30/41-17 (3343F041, 4223073M1)	30/41-18 (3343J021, 4223074M1)	30/42-38 (3142L051, 748413M1)	30/43-26 (3142A051, 748309M1)
3075, 4245, 4255, 6130, 6140, 6150	1004.4T (Blue)			30/42-39 (3142L072, 3640597M1)	
374, 3220, 3330, 4225, 4325	1004.40 (Green)	30/41-61 (3313A012, 4223987M1)	30/41-62 (3318A705, 4223581M1)	30/42-61 (3142L081, 4222149M91)	30/43-61 (3142D051, 4222147M91)
3350, 3355, 4235, 4245, 4345, 6235, 6245	1004.40T (Green)				
4265, 4365, 6265	1004.40TW (Green)				
4255, 4355, 6255	1004.40T (Green)			30/42-62 (3142D041, 4222894M1)	30/43-62 (3142D031, 4222896M1)
394, 2230, 3235, 3340, 4235 (USA), 4335	1004.42 (Green)			30/42-63 (3142H041, 4222952M1)	30/43-63 (3142D061, 4222957M1)

Part numbers are quoted for reference purposes only.
Our parts and accessories are not original.

Las referencias originales tienen un propósito identificativo.
Nuestras piezas no son originales.



CYLINDER HEAD PARTS CULATAS Y PIEZAS ANEXAS



Tractors <i>Tractores</i>	Engine <i>Motor</i>	2 Inlet guide <i>Guía adm.</i>	3 Exhaust guide <i>Guía escape</i>	4 Inlet valve <i>Válvula adm.</i>	5 Exhaust valve <i>Válvula escape</i>
6 cylinder engines / Motores 6 cilindros					
1100	A6.354				30/43-9 (3142A052, 747552M1)
1014, 1104, 1200	A6.354.1				30/43-26 (3142A051, 748309M1)
399, 699, 1014, 1024, 1114, 1230, 2620, 2625, 2640, 2645, 2675, 3080, 3090, 3610	A6.354.4			30/42-9 (31431315, 733820M1)	30/43-9 (3142A052, 747552M1)
1105 1130 1135	ATC6.354.1 AT6.354 AT6.354.1				
1134, 2680, 2685, 2705, 2720, 2725, 3630, 3650	AT6.354.4				
396, 399, 3085, 3095, 3115, 4260, 4270, 6160, 6170 <i>Valve angle 45°/Ángulo de válvula</i>	1006.6 (Blue) <i>Cyl. head / Culata</i> ZZ80225	30/41-17 (3343F041, 4223073M1)	30/41-18 (3343J021, 4223074M1)	30/42-38 (3142L051, 748413M1)	
3120, 3120T, 3125, 3140, 3635 (⇒ U557976X) <i>Valve angle 45°/Ángulo de válvula</i>	1006.6T (Blue) <i>Cyl. head / Culata</i> ZZ80225				30/43-26 (3142A051, 748309M1)
3645, 3655, 3660 (⇒ U557976X) <i>Valve angle 45°/Ángulo de válvula</i>	1006.6T (Blue) <i>Cyl. head / Culata</i> ZZ80226			30/42-71 (3142L071, 3637042M1)	
3120, 3120T, 3125, 3140, 3635, 3645, 3655, 3660 (U557977X ⇒) 6180, 6190, 8110, 8120, 8130 <i>Inlet valve angle 30° Ángulo de válvula adm.</i>	1006.6T (Blue)			30/42-39 (3142L072, 3640597M1)	
4260, 4360, 6260	1006.60 (Green)			30/42-61 (3142L081, 4222149M91)	30/43-61 (3142D051, 4222147M91)
4270, 4370, 6170, 6180, 6270, 6280, 6290, 8120, 8220	1006.60T (Green)	30/41-61 (3313A012, 4223987M1)	30/41-62 (3318A705, 4223581M1)		
8210	1006.60T			30/42-62 (3142D041, 4222894M1)	30/43-62 (3142D031, 4222896M1)

Part numbers are quoted for reference purposes only.
Our parts and accessories are not original.

Las referencias originales tienen un propósito identificativo.
Nuestras piezas no son originales.



CYLINDER HEAD PARTS
CULATAS Y PIEZAS ANEXAS



Tractors <i>Tractores</i>	Engine <i>Motor</i>	2 Inlet guide <i>Guía admis.</i>	3 Exhaust guide <i>Guía escape</i>	4 Inlet valve <i>Válvula admis.</i>	5 Exhaust valve <i>Válvula escape</i>
 6 cylinder engines / Motores 6 cilindros					
3680, 3690	612DS	30/41-51 (V836136051, 3637640M1)		30/42-51 (V836328735, 3637642M1)	30/43-51 (V836328734, 3637641M1)
3670, 8140, 8150	620DS	30/41-52 (V836647601)		30/42-52 (V836646356, 3638961M91)	30/43-52 (V836646357, 3638962M91)
8240	620DSRAE				
8240Xtra	620DWBAE				
3690, 8160	634DS				
8250, 8260	634DSBAE				
8250Xtra, 8260Xtra	634DWBAE				
8260	634DSBIE				
8170, 8180, 8270, 8280	645DSBIE				
8270Xtra, 8280Xtra	645DSBAE				

Part numbers are quoted for reference purposes only.
Our parts and accessories are not original.

*Las referencias originales tienen un propósito identificativo.
Nuestras piezas no son originales.*



CYLINDER HEAD PARTS CULATAS Y PIEZAS ANEXAS



Tractors <i>Tractores</i>	Engine <i>Motor</i>	1 Cyl. Head Assy. <i>Culata armada</i>	2 Inlet guide <i>Guía adm.</i>	3 Exhaust guide <i>Guía escape</i>	4 Inlet valve <i>Válvula adm.</i>	5 Exhaust valve <i>Válvula escape</i>
4 cylinder engines combines / Cosechadoras motores 4 cilindros						
186	A4.212	30/40-6 (2280175, 3640877M91)	30/41-17 (A) (3343F041, 4223073M1)	30/41-18 (A) (3343J021, 4223074M1)	(A) Low rated <i>Especf. estan.</i> 30/42-6 (31431641, 739027M1)	(A) Low rated <i>Especf. estan.</i> 30/43-6 (31431881, 741466M1)
8 Plot, 10 Plot, 16 Plot, 16, 99, 187, 206, 240, 307, 330	A4.236				High rated <i>Especf. super.</i> 30/42-9 (31431315, 735820M1)	High rated <i>Especf. super.</i> 30/43-9 (3142A052, 747552M1)
20, 430, 440, 487, 506	A4.248				30/42-25 (3142H002, 746823M1)	30/43-9 (3142A052, 747552M1)
20XP	AT4.236					
788	A4.270					
400, 410, 415	A4.300		30/41-8 (33432532, 738094M1)	30/42-16 (31431154, 738095M1)	30/43-16 (31431671, 738944M1)	
6 cylinder engines combines / Cosechadoras motores 6 cilindros						
500, 507, 510, 515, 520, 525	A6.354					30/43-9 (3142A052, 747552M1)
24, 27, 530, 530S, 535, 800, 805, 810, 815	A6.354.4					30/43-26 (3142A051, 748309M1)
750, 760	AT6.354.1					30/43-9 (3142A052, 747552M1)
29, 29XP, 31, 560, 565, 660, 665, 750, 760, 820, 825, 830, 835, 840, 845, 850, 855, 860	AT6.354.4		30/41-17 (3343F041, 4223073M1)	30/41-18 (3343J021, 4223074M1)	30/42-9 (31431315, 735820M1)	30/43-26 (3142A051, 748309M1)
31XP	AT6.354.4					
620, 625, 740, 750	A6.372					30/43-9 (3142A052, 747552M1)
750	A6.372.4					30/43-26 (3142A051, 748309M1)

(A) Oversize valves are available for cyl. head Assy. (©1985) which were not fitted with valve guides. See Page MF-77 for details.
Las válvulas a sobremedida están disponibles para culatas (©1985) sin guías de válvula montadas. Ver página MF-77 para detalles.

Part numbers are quoted for reference purposes only.
Our parts and accessories are not original.

Las referencias originales tienen un propósito identificativo.
Nuestras piezas no son originales.



CYLINDER HEAD PARTS CULATAS Y PIEZAS ANEXAS



Tractors Tractores	Engine Motor	1 Cyl. Head assy. Culata armada	2 Inlet guide Guaia adms.	3 Exhaust guide Guaia escape	4 Inlet valve Válvula adms.	5 Exhaust valve Válvula escape
Telescopic handlers / Carretillas elevadoras telescópicas						
24	A4.236	30/40-6 (ZZ80175, 3640877M91)	30/41-17 (A) (3343F041, 4223073M1)	30/41-18 (A) (3343J021, 4223074M1)	(A) Low rated <i>Especf. estan.</i> 30/42-6 (31431641, 739027M1) High rated <i>Especf. super.</i> 30/42-9 (31431315, 735820M1)	(A) Low rated <i>Especf. estan.</i> 30/43-6 (31431881, 741466M1) High rated <i>Especf. super.</i> 30/43-9 (3142A052, 747552M1)
24T	AT4.236				30/42-25 (3142H002, 746823M1)	30/43-9 (3142A052, 747552M1)
8925, 8926, 8937, 8939	1004.4 (Blue)				30/42-38 (3142L051, 748413M1)	30/43-26 (3142A051, 748309M1)
8925T, 8926T, 8937T, 8939T	1004.4T (Blue)				30/42-39 (3142L072, 3640597M1)	
8925, 8926, 8937, 8939	1004.42 (Green)		30/41-61 (3313A012, 4223987M1)	30/41-62 (3318A705, 4223581M1)	30/42-63 (3142H041, 4222952M1)	30/43-63 (3142D061, 4222957M1)
8925T, 8926T, 8937T, 8939T	1004.40T (Green)				30/42-62 (3142D041, 4222894M1)	30/43-62 (3142D031, 4222896M1)

(A) Oversize valves are available for cyl. head assy. (≠1985) which were not fitted with valve guides. See Page MF-77 for details.
Las válvulas a sobremedida están disponibles para culatas (≠1985) sin guías de válvula montadas. Ver página MF-77 para detalles.

Part numbers are quoted for reference purposes only.
Our parts and accessories are not original.

*Las referencias originales tienen un propósito identificativo.
Nuestras piezas no son originales.*



CYLINDER HEAD PARTS CULATAS Y PIEZAS ANEXAS



Tractors <i>Tractores</i>	Engine <i>Motor</i>	1 Cyl. Head assy. <i>Culata armada</i>	2 Inlet guide <i>Guisa adms.</i>	3 Exhaust guide <i>Guisa escape</i>	4 Inlet valve <i>Válvula adms.</i>	5 Exhaust valve <i>Válvula escape</i>
3 cylinder engine industrial tractors / Palas retrocargadoras motores 3 cilindros						
203, 205	A3.152	30/40-1 (ZZ80048, 3638321M91)	30/41-3 (3316A031, 4223519M1)		30/42-3 (31431261, 731151M1)	30/43-3 (0910002, 731152M1)
20, 40	AG3.152		30/41-19 (3313E734, 4223455M1)		30/42-27 (31431741, 739641M1)	30/43-27 (31431731, 739439M1)
20, 20B, 40, 203, 205, 2135, 2203, 2205 (⇒U584638F) <i>Válvulo angle 45°/ángulo de válvulo</i>	AD3.152 <i>Cyl. head / Culata</i> 86550 & 68128				30/42-4 (31431281, 732811M1)	30/43-4 (31431591, 737640M1)
20, 20B, 40, 203, 205, 2135, 2203, 2205 (U584639F ⇒) <i>Válvulo angle 35°/ángulo de válvulo</i>	AD3.152 <i>Cyl. head / Culata</i> 89141 ⇒ ZZ80082	30/40-3 (ZZ80082, ZZ80235, 3637389M91, 4222810M91)		30/41-3 (3316A031, 4223519M1)		30/43-5 (31431011, 3142A081, 747581M1, 3637529M1)
20C, 20D, 20E, 20F, 30B, 30E, 30H	AD3.152 <i>Cyl. head / Culata</i> ZZ80235		30/41-3 (3316A031, 4223519M1)	30/41-19 (3313E734, 4223455M1)	30/42-5 (31431681, 739060M1)	30/43-24 (31431031, 3637616M1)
40E (CN31157, CN31158)	AT3.152.4		30/41-20 (U3316A032, 4223487M1)	30/41-3 (3316A031, 4223519M1)	30/42-24 (31431981, 745534M1)	30/43-5 (31431011, 3142A081, 747581M1, 3637529M1)
40E (CN31195, CN31196)	AT3.152.4			30/41-19 (3313E734, 4223455M1)	30/42-26 (31431121, 3637528M1)	

Part numbers are quoted for reference purposes only.
Our parts and accessories are not original.

Las referencias originales tienen un propósito identificativo.
Nuestras piezas no son originales.



CYLINDER HEAD PARTS
CULATAS Y PIEZAS ANEXAS



Tractors Tractores	Engine Motor	Cyl. Head Assy. Culata armada	Inlet guide Guía admx.	Exhaust guide Guía escape	Inlet valve Válvula admx.	Exhaust valve Válvula escape
4 cylinder engine industrial tractors / Palas retrocargadoras motores 4 cilindros						
702	23C Diesel		30/41-1 (825259M1)	30/41-2 (826162M1)	30/42-2 (1884123M1)	30/43-2 (1884124M1)
356	A4.203	30/40-4 (ZZ80089, 3637485M91)	30/41-3 (3316A031, 4223519M1)		30/42-3 (31431261, 731151M1)	30/43-3 (0910002, 731152M1)
30, 40B, 50, 302, 304, 356, 316S, 3303, 3305	AD4.203	30/40-5 (ZZ80033, 3637384M91)			30/42-4 (31431281, 732811M1)	30/43-4 (31431591, 737640M1)
50, 50B, 3303, 3305	A4.212				(A) Low rated Especf. estan. 30/42-6 (31431641, 739027M1)	(A) Low rated Especf. estan. 30/43-6 (31431881, 741466M1)
30D, 50, 50B, 50BMMKII, 50C, 50D, 50E, 50H, 50H-S, 50H-T, 60	A4.236	30/40-6 (ZZ80175, 3640877M91)	30/41-17 (A) (3343F041, 4223073M1)	30/41-18 (A) (3343J021, 4223074M1)	High rated Especf. super. 30/42-9 (31431315, 735820M1)	High rated Especf. super. 30/43-9 (3142A052, 747552M1)
50EX, 50HX, 50HX-S, 50HX-T, 60H, 60H-S	A4.248				30/42-25 (3142H002, 746823M1)	30/43-9 (3142A052, 747552M1)
60HX, 60HX-T	AT4.236					
70	A4.318		30/41-8 (33432532, 738094M1)		30/42-16 (31431154, 738095M1)	30/43-16 (31431671, 738944M1)
Ferret & Terex - 4 cylinder engine industrial tractors / Palas retrocargadoras motores 4 cilindros						
750	1004.4 (Blue)				30/42-38 (3142L051, 748413M1)	
760, 860, 860S, 860SE, 865, 960, 965 (⇒ U608300W) Válvula ángulo 45° Ángulo de válvula	1004.4T (Blue)		30/41-17 (3343F041, 4223073M1)	30/41-18 (3343J021, 4223074M1)		30/43-26 (3142A051, 748309M1)
760, 860, 860S, 860SE, 865, 960, 965 (U608301W ⇒) Inlet valve angle 30° Ángulo de válvula admx. 30°	1004.4T (Blue)				30/42-39 (3142L072, 3640597M1)	
750, 750B	1004.42 (Green)		30/41-61 (3313A012, 4223987M1)	30/41-62 (3318A705, 4223581M1)	30/42-63 (3142H041, 4222952M1)	30/43-63 (3142D061, 4222957M1)
760, 760B, 860, 860B, 860S, 860SE, 960, 960B, 965	1004.40T (Green)				30/42-62 (3142D041, 4222894M1)	30/43-62 (3142D031, 4222896M1)

(A) Oversize valves are available for cyl. head Assy. (©1985) which were not fitted with valve guides. See Page MF-77 for details.
Las válvulas a sobremedida están disponibles para culatas (©1985) sin guías de válvula montadas. Ver página MF-77 para detalles.

Part numbers are quoted for reference purposes only.
Our parts and accessories are not original.

Las referencias originales tienen un propósito identificativo.
Nuestras piezas no son originales.



**CYLINDER HEAD PARTS
CULATAS Y PIEZAS ANEXAS**

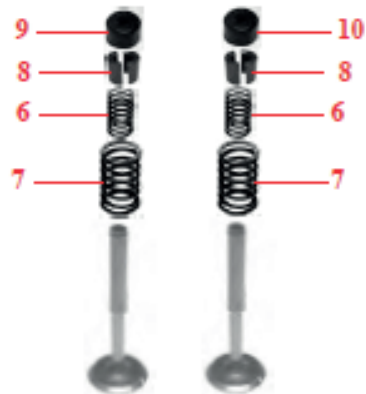

Tractors <i>Tractores</i>	Engine <i>Motor</i>	6 Inner spring <i>Muelle interior</i>	7 Outer spring <i>Muelle exterior</i>	8 Cotter <i>Semi-conos</i>	9 Inlet seal <i>Retén adm.</i>	10 Exhaust seal <i>Retén escape</i>
3 cylinder engines / Motores 3 cilindros						
35, 133, 135	A3.144					
35	A3.152					
135	AG3.152	30/44-3 (0780007, 731153M1)	30/45-3 (0780006, 731154M1)		30/47-60 (2415258, 1446022M91)	
133, 134, 135, 140, 145, 148, 150, 152, 154, 230, 233, 234, 235, 240, 244CF, 245, 250, 253 (Italy), 254, 255, 333, 334V, 340, 342, 350, 353, 354, 356CF, 550, 2205, 3210	AD3.152 <i>Cyl. head / Culata</i> ⇒ ZZ80082					
	AD3.152 <i>Cyl. head / Culata</i> ZZ80235		30/45-60 (0780012, 3637678M1)	30/46-1 (0230001, 731155M1)		
164T, 263T (Italy), 264T 355, 360 (CN31187)	AT3.152.4	Inlet only <i>Únic. adm.</i> 30/44-3 (0780007, 731153M1)	30/45-3 (0780006, 731154M1)		30/47-60 (2415258, 1446022M91)	
253 (UK), 264TCF 352, 355 (CN31256) 360 (CN31185) 363, 364, 366CF	AT3.152.4					
2210, 3315, 4215, 4315	903.27		30/45-17 (3174P002, 4222584M1)	30/46-13 (3142W003, 4222586M1)	30/47-66 (2418M508, 4224300M1)	
263 (UK), 2220, 3325, 4220, 4320	903.27T					

Part numbers are quoted for reference purposes only.
Our parts and accessories are not original.

Las referencias originales tienen un propósito identificativo.
Nuestras piezas no son originales.



CYLINDER HEAD PARTS
CULATAS Y PIEZAS ANEXAS

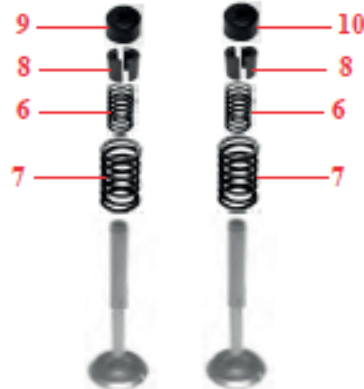

		6	7	8	9	10
Tractors <i>Tractores</i>	Engine <i>Motor</i>	Inner spring <i>Muelle interior</i>	Outer spring <i>Muelle exterior</i>	Cotter <i>Semi-conos</i>	Inlet seal <i>Retén adm.</i>	Exhaust seal <i>Retén escape</i>
4 cylinder engines / Motores 4 cilindros						
TEA20 TED20 TEH20	85mm Petrol 85mm VO 85mm LO		30/45-11 (825186M1)			
TEF20	20C Diesel	30/44-1 (103369)	30/45-1 (103368)			
FE35, 835	23C Diesel	30/44-2 (1884126M1)	30/45-2 (1884125M1)			
35, 135	87mm Petrol		30/45-11 (825186M1)			
25, 122	A4.99				30/47-7 (33817403, 3639965M1)	
25, 30, 130, 825	A4.107					
65	A4.192	30/44-3 (0780007, 731153M1)				
65, 865	A4.203					
65, 155, 158, 165, 765, 260, 560 (⇨ U546167F) <i>Válvulo ángulo 45° Ángulo de válvula</i>	AD4.203		30/45-3 (0780006, 731154M1)	30/46-1 (0230001, 731155M1)		
158MKIII 260, 560 (U546168F ⇨) <i>Válvulo ángulo 35° Ángulo de válvula</i>	AD4.203	Inlet only <i>Únic. adm.</i> 30/44-3 (0780007, 731153M1)			30/47-60 (2415258, 1446022M91)	
165, 174	A4.212	Ø 1.00" - 25mm Lg 2.09" - 53mm	Ø 1.41" - 36mm Lg 2.38" - 66mm			
168, 168MKIII, 174, 175, 184, 235 (USA), 265, 273, 274, 275, 275E, 283, 284, 362, 362N, 365, 367CF, 372N, 373, 374, 375, 375E, 376C, 377, 383, 384, 387, 565, 575, 675, 3050, 3220, 3225	A4.236	30/44-4 (31744131, 31744127, 735525M1, 747813M1)	30/45-4 (31745121, 31745117, 735521M1, 747814M1)		30/47-1 (33817117, 3637041M1)	Seal <i>Junta</i> 30/47-1 (33817117, 3637041M1) With spring <i>Con muelle</i> 30/47-1S
178, 185, 188, 194, 285, 290, 290E, 293, 294, 382N, 390, 390E, 393, 394, 396C, 397, 590, 690, 3050, 3060, 3235	A4.248	Ø 1.10" - 28mm Lg 1.72" - 44mm	Ø 1.48" - 38mm Lg 1.84" - 47mm	30/46-2 (33173108, 736453M1)	With spring <i>Con muelle</i> 30/47-1S	O-ring <i>Junta torica</i> 30/47-67 (2415B201, 1447652M1)
390T, 393TLX, 394TAQ, 396CT, 397T, 398, 698T, 1004T, 1007, 3065, 3065S, 3070	AT4.236	30/44-4 (31744131, 735525M1)	30/45-4 (31745121, 735521M1)			

Part numbers are quoted for reference purposes only.
Our parts and accessories are not original.

Las referencias originales tienen un propósito identificativo.
Nuestras piezas no son originales.

**CYLINDER HEAD PARTS
CULATAS Y PIEZAS ANEXAS**

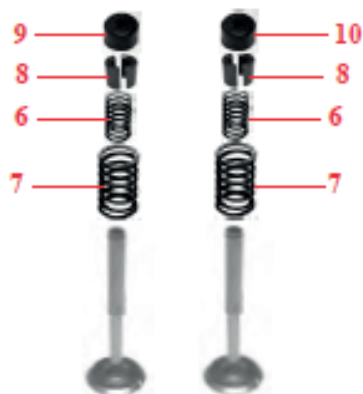

Tractors Tractores	Engine Motor	6 Inner spring Muelle interior	7 Outer spring Muelle exterior	8 Cotter Semi-conos	9 Inlet seal Retén adm.	10 Exhaust seal Retén escape
4 cylinder engines / Motores 4 cilindros						
285 (USA), 592, 595, 1080, 1085	A4.318	30/44-4 (31744131, 735525M1)	30/45-4 (31745121, 735521M1)			
285 (USA), 298, 592, 595, 698, 1004	A4.318.2					
275E, 290E, 375E, 390E, 4225, 4235, 4240, 6110, 6120	A4.41 (Blue)	Double / Doble 30/44-67 (31744133, 740465M1)	Single / Simple 30/45-62 (3174P405, 3637057M1) Double / Doble 30/45-61 (31745122, 740467M1)	30/46-2 (33173108, 736453M1)	30/47-1 (33817117, 3637041M1) With spring Con muelle 30/47-15	
3075, 4245, 4255, 6130, 6140, 6150	1004.4T (Blue)	30/44-67 (31744133, 740465M1)	30/45-61 (31745122, 740467M1)			
374, 3220, 3330, 4225, 4325	1004.40 (Green)					
3350, 3355, 4235, 4245, 4255, 4345, 4355, 6235, 6245, 6255	1004.40T (Green)		30/45-63 (3174P409, 4224316M1)	30/46-14 (3142W004, 4222141M1)	30/47-63 (2418M506, 4222333M1)	30/47-65 (2418M505, 4223442M1)
4265, 4365, 6265	1004.40TW (Green)					
394, 2230, 3235, 3340, 4235 (USA), 4335	1004.42 (Green)		30/45-64 (3174P412, 4224006M1)		30/47-64 (2418M507, 4224007M1)	

Part numbers are quoted for reference purposes only.
Our parts and accessories are not original.

Las referencias originales tienen un propósito identificativo.
Nuestras piezas no son originales.



CYLINDER HEAD PARTS CULATAS Y PIEZAS ANEXAS

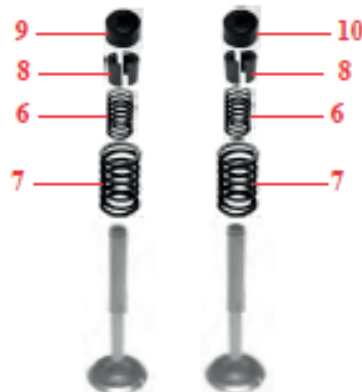

Tractors <i>Tractores</i>	Engine <i>Motor</i>	6 Inner spring <i>Muelle interior</i>	7 Outer spring <i>Muelle exterior</i>	8 Cotter <i>Semi-conos</i>	9 Inlet seal <i>Retén adm.</i>	10 Exhaust seal <i>Retén escape</i>
6 cylinder engines / Motores 6 cilindros						
1100	A6.354	Ø 1.00"-25mm Lg 2.09"-53mm	Ø 1.41"-36mm Lg 2.38"-66mm		30/47-2 (33817402, 733820M1)	
1014, 1104, 1200	A6.354.1	30/44-4 (31744131, 31744127, 735525M1, 747813M1)	30/45-4 (31745121, 31745117, 735521M1, 747814M1)		30/47-1 (33817117, 3637041M1)	
399, 699, 1014, 1024, 1114, 1250, 2620, 2625, 2640, 2645, 2675, 3080, 3090, 3610	A6.354.4				With spring / <i>Con muelle</i> 30/47-1S	
1105 1130 1135	AT6.354.1 AT6.354 AT6.354.1	Ø 1.10"-28mm Lg 1.72"-44mm	Ø 1.48"-38mm Lg 1.84"-47mm		30/47-2 (33817402, 733820M1)	
1134, 2680, 2685, 2705, 2720, 2725, 3630, 3650	AT6.354.4	30/44-67 (31744133, 740465M1)	30/45-61 (31745122, 740467M1)	30/46-2 (33173108, 736453M1)		
396, 399, 3085, 3095, 3115, 4260, 4270, 6160, 6170	1006.6 (Blue)		Single <i>Simple</i> 30/45-62 (3174P405, 3637057M1)			30/47-1 (33817117, 3637041M1)
3120, 3120T, 3125, 3140 3635 (⇔ U557976X)	1006.6T (Blue)	Double / <i>Doble</i> 30/44-67 (31744133, 740465M1)	Double / <i>Doble</i> 30/45-61 (31745122, 740467M1)			With spring / <i>Con muelle</i> 30/47-1S
3120, 3120T, 3125, 3140 3635 (U557977X ⇔) 3645, 3655, 3660, 6180, 6190, 8110, 8120, 8130	1006.6T (Blue)	30/44-67 (31744133, 740465M1)	30/45-61 (31745122, 740467M1)			
4260, 4360, 6260	1006.60 (Green)		30/45-63 (3174P409, 4224316M1)	30/46-14 (3142W004, 4222141M1)	30/47-63 (2418M506, 4222333M1)	30/47-65 (2418M505, 4223442M1)
4270, 4370, 6170, 6180, 6270, 6280, 6290, 8120, 8210, 8220	1006.60T (Green)					
3680, 3690	612DS	30/44-51 (V836006574, 3638929M1)	30/45-51 (V836117910, 3638934M1)	30/46-51 (V836006578, 3638931M1)		
3670, 8140, 8150	620DS					
8240	620DSRAE					
8240Xtra	620DWBAE					
3690, 8160	634DS					
8250, 8260	634DSBAE		30/45-52 (V836646380, 3638964M1)	30/46-52 (V836646382, 3638966M1)		
8250Xtra, 8260Xtra	634DWBAE					
8260	634DSBIE					
8170, 8180, 8270, 8280	645DSBIE					
8270Xtra, 8280Xtra	645DSBAE					

Part numbers are quoted for reference purposes only.
Our parts and accessories are not original.

Las referencias originales tienen un propósito identificativo.
Nuestras piezas no son originales.



**CYLINDER HEAD PARTS
CULATAS Y PIEZAS ANEXAS**

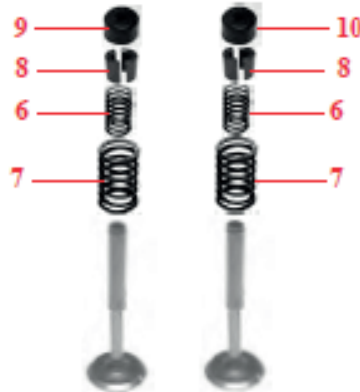

Tractors Tractores	Engine Motor	6 Inner spring Muelle interior	7 Outer spring Muelle exterior	8 Cotter Semi-conos	9 Inlet seal Retén adms.	10 Exhaust seal Retén escape		
4 cylinder engines combines / Cosechadoras motores 4 cilindros								
186	A4.212	Ø 1.00"-25mm Lg 2.09"-53mm 30/44-4 (31744131, 3174412F7, 735525M1, 747813M1)	Ø 1.41"-36mm Lg 2.58"-66mm 30/45-4 (31745121, 31745117, 735521M1, 747814M1)	30/46-2 (33173108, 736453M1)	30/47-1 (33817117, 3637041M1) With spring Con muelle 30/47-1S	Seal Junta 30/47-1 (33817117, 3637041M1)		
8 Plot, 10 Plot, 16 Plot, 16, 99, 187, 206, 240, 307, 330	A4.236					With spring Con muelle 30/47-1S	With spring Con muelle 30/47-1S	
20, 430, 440, 487, 506	A4.248	Ø 1.10"-28mm Lg 1.72"-44mm 30/44-67 (31744133, 740465M1)	Ø 1.48"-38mm Lg 1.84"-47mm 30/45-61 (31745122, 740467M1)				O-ring Junta tórica 30/47-67 (2415B201, 1447652M1)	
20XP	AT4.236	30/44-4 (31744131, 735525M1)	30/45-4 (31745121, 735521M1)					
788	A4.270							
400, 410, 415	A4.300							
6 cylinder engines combines / Cosechadoras motores 6 cilindros								
500, 507, 510, 515, 520, 525	A6.354	Ø 1.00"-25mm Lg 2.09"-53mm 30/44-4 (31744131, 31744127, 735525M1, 747813M1)	Ø 1.41"-36mm Lg 2.58"-66mm 30/45-4 (31745121, 31745117, 735521M1, 747814M1)	30/46-2 (33173108, 736453M1)	30/47-2 (33817402, 733820M1)			
24, 27, 530, 530S, 535, 800, 805, 810, 815	A6.354.4				30/47-1 (33817117, 3637041M1)	With spring / Con muelle 30/47-1S		
750, 760	AT6.354.1				30/47-2 (33817402, 733820M1)			
29, 29XP, 31, 31XP, 560, 565, 660, 665, 750, 760, 820, 825, 830, 835, 840, 845, 850, 855, 860	AT6.354.4				30/47-1 (33817117, 3637041M1)			
620, 625, 740, 750	A6.372				With spring / Con muelle 30/47-1S			
750	AT6.372.4							

Part numbers are quoted for reference purposes only.
Our parts and accessories are not original.

Part numbers are quoted for reference purposes only.
Our parts and accessories are not original.



CYLINDER HEAD PARTS
CULATAS Y PIEZAS ANEXAS



		6	7	8	9	10	
Tractors <i>Tractores</i>	Engine <i>Motor</i>	Inner spring <i>Muelle interior</i>	Outer spring <i>Muelle exterior</i>	Cotter <i>Semi-comos</i>	Inlet seal <i>Retén adms.</i>	Exhaust seal <i>Retén escape</i>	
Telescopic handlers / Carretillas elevadoras telescópicas							
24	A4.236	Ø 1.00"- 25mm Lg 2.09"-53mm 30/44-4 (31744131, 31744127, 735525M1, 747813M1)	Ø 1.41"- 36mm Lg 2.38"-66mm 30/45-4 (31745121, 31745117, 735521M1, 747814M1)	30/46-2 (33173108, 736453M1)	30/47-1 (33817117, 3637041M1)	Seal <i>Junta</i> 30/47-1 (33817117, 3637041M1) With spring <i>Con muelle</i> 30/47-1S	
24T	AT4.236	Ø 1.10"- 28mm Lg 1.72"-44mm 30/44-67 (31744133, 740465M1)	Ø 1.48"- 38mm Lg 1.84"-47mm 30/45-61 (31745122, 740467M1)		With spring <i>Con muelle</i> 30/47-1S	O-ring <i>Junta tórica</i> 30/47-67 (2415B201, 1447652M1)	
8925, 8926, 8937, 8939	1004.4 (Blue)	30/44-67 (31744133, 740465M1)	30/45-61 (31745122, 740467M1)		30/47-1 (33817117, 3637041M1)	With spring / <i>Con muelle</i> 30/47-1S	
8925T, 8926T, 8937T, 8939T	1004.4T (Blue)						
8925, 8926, 8937, 8939	1004.42 (Green)		30/45-64 (3174P412, 4224006M1)	30/46-14 (3142W004, 4222141M1)	30/47-64 (2418M507, 4224007M1)	30/47-65 (2418M505, 4223442M1)	
8925T, 8926T, 8937T, 8939T	1004.40T (Green)		30/45-63 (3174P409, 4224316M1)		30/47-63 (2418M506, 4222333M1)		
3 cylinder engine industrial tractors / Palas retrocargadoras motores 3 cilindros							
203, 205	A3.152						
20, 40	AG3.152	30/44-3 (0780007, 731153M1)	30/45-3 (0780006, 731154M1)	30/46-1 (0230001, 731155M1)	30/47-60 (2415258, 1446022M91)		
20, 20B, 20C, 20D, 20E, 20F, 30B, 30E, 30H, 40, 203, 205, 2135, 2203, 2205	AD3.152 <i>Cyl. head / Culata</i> ⇒ ZZ80082						
	AD3.152 <i>Cyl. head / Culata</i> ZZ80235		30/45-60 (0780012, 3637678M1)				
40E (CN31157, CN 31158)	AT3.152.4	Inlet only <i>Únic. adms.</i> 30/44-3 (0780007, 731153M1)	30/45-3 (0780006, 731154M1)		30/47-60 (2415258, 1446022M91)		
40E (CN31195, CN 31196)	AT3.152.4						

Part numbers are quoted for reference purposes only.
Our parts and accessories are not original.

Las referencias originales tienen un propósito identificativo.
Nuestras piezas no son originales.



CYLINDER HEAD PARTS CULATAS Y PIEZAS ANEXAS

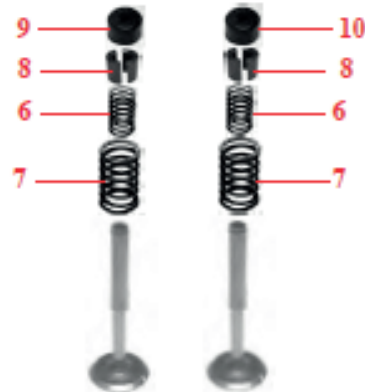

Tractors Tractores	Engine Motor	6 Inner spring Muelle interior	7 Outer spring Muelle exterior	8 Cotter Semi-conos	9 Inlet seal Retén admx.	10 Exhaust seal Retén escape
4 cylinder engine industrial tractors / Palas retrocargadoras motores 4 cilindros						
702	23C Diesel	30/44-2 (1884126M1)	30/45-2 (1884125M1)			
356	A4.203	30/44-3 (0780007, 731153M1)	30/45-3 (0780006, 731154M1)	30/46-1 (0230001, 731155M1)		
30, 40B, 50, 302, 304, 356, 3165, 3303, 3305	AD4.203					
50, 50B, 3303, 3305	A4.212					
30D, 50, 50B, 50BMKII, 50C, 50D, 50E, 50H, 50H-S, 50H-T, 60	A4.236	Ø 1.00" - 25mm Lg 2.09" - 53mm 30/44-4 (31744131, 31744127, 735525M1, 747813M1)	Ø 1.41" - 36mm Lg 2.58" - 66mm 30/45-4 (31745121, 31745117, 735521M1, 747814M1)		30/47-1 (33817117, 3637041M1)	Seal Junta 30/47-1 (33817117, 3637041M1)
50EX, 50HX, 50HX-S, 50HX-T, 60H, 60H-S	A4.248	Ø 1.10" - 28mm Lg 1.72" - 44mm 30/44-67 (31744133, 740465M1)	Ø 1.48" - 38mm Lg 1.84" - 47mm 30/45-61 (31745122, 740467M1)	30/46-2 (33173108, 736453M1)	With spring Con muelle 30/47-1S	With spring Con muelle 30/47-1S
60HX, 60HX-T	AT4.236					
70	A4.318	30/44-4 (31744131, 735525M1)	30/45-4 (31745121, 735521M1)			
Ferroc & Terex - 4 cylinder engine industrial tractors / Palas retrocargadoras motores 4 cilindros						
750	1004.4 (Blue)		30/45-62 (3174P405, 3637057M1)	30/46-2 (33173108, 736453M1)	30/47-1 (33817117, 3637041M1)	
760, 860, 860S, 860SE, 865, 960, 965	1004.4T (Blue)				With spring / Con muelle 30/47-1S	
750, 750B	1004.42 (Green)		30/45-64 (3174P412, 4224006M1)	30/46-14 (3142W004, 4222141M1)	30/47-64 (2418M507, 4224007M1)	30/47-65 (2418M505, 4223442M1)
760, 760B, 860, 860B, 860S, 860SE, 960, 960B, 965	1004.40T (Green)		30/45-63 (3174P409, 4224316M1)		30/47-63 (2418M506, 4222333M1)	

Part numbers are quoted for reference purposes only.
Our parts and accessories are not original.

Las referencias originales tienen un pequeño identificador.
Nuestras piezas no son originales.



CYLINDER HEAD PARTS
CULATAS Y PIEZAS ANEXAS

Inlet / Admisión				
Ref. Ref.	OA (mm)	OB (mm)	L (mm)	D (mm)
30/42-1	31.8	7.9	107.4	45°
30/42-2	38.4	7.9	110.0	45°
30/42-3	39.0	7.9	114.3	45°
30/42-4	39.0	7.9	114.3	45°
30/42-5	39.0	7.9	114.3	35°
30/42-6	44.2	9.5	123.0	45°
30/42-9	44.2	9.5	123.1	45°
30/42-15	35.7	7.9	117.0	45°
30/42-16	46.9	9.5	135.5	45°
30/42-19	28.2	7.8	108.3	45°
30/42-20	33.7	7.9	108.4	45°
30/42-24	39.0	7.9	114.5	45°
30/42-25	44.2	9.5	122.8	35°
30/42-26	38.9	7.9	114.2	35°
30/42-27	39.0	7.9	114.3	45°
30/42-38	45.0	9.5	122.9	45°
30/42-39	45.1	9.5	123.0	30°
30/42-51	44.7	8.2	148.5	45°
30/42-52	47.9	8.9	151.66	35°
30/42-60	41.8	6.9	115.3	35°
30/42-61	43.0	8.9	122.9	35°
30/42-62	42.9	8.9	122.9	45°
30/42-63	42.9	8.9	124.0	45°

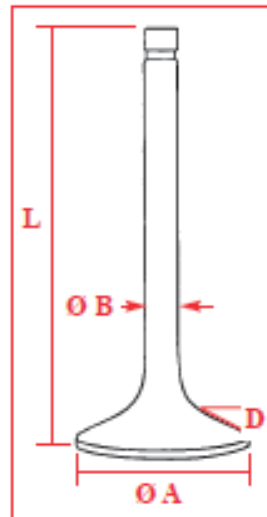

Outlet / Escape				
Ref. Ref.	OA (mm)	OB (mm)	L (mm)	D (mm)
30/43-1	28.6	7.9	107.4	45°
30/43-2	31.0	9.5	110.7	45°
30/43-3	33.4	7.9	114.3	45°
30/43-4	33.4	7.9	114	45°
30/43-5	33.4	7.9	114.2	35°
30/43-6	36.6	9.5	123.3	45°
30/43-9	36.6	9.5	122.3	45°
30/43-15	30.3	7.9	117.0	45°
30/43-16	40.5	9.4	132.4	45°
30/43-19	26.5	7.9	108.2	45°
30/43-20	31.4	9.5	106.6	45°
30/43-24	33.5	7.9	114.3	45°
30/43-26	37.4	9.5	123.3	45°
30/43-27	33.5	7.9	114.5	45°
30/43-60	37.9	6.9	115.4	45°
30/43-61	41.0	8.9	122.9	35°
30/43-62	41.0	8.9	122.9	45°
30/43-63	41.9	8.9	124.0	45°
30/43-51	39.8	9.4	148.0	35°
30/43-52	40.9	8.9	152.6	45°

Oversize valves are available for cyl. head assy. (⇒1985) which were fitted without valve guides.
Las válvulas a sobremedida están disponibles para culatas (⇒1985) sin guías de válvula montadas.

	Inlet valve Válvula admisión		Exhaust valve Válvula escape	
	Low rated Especf. estm.	High rated Especf. superior	Low rated Especf. estm.	High rated Especf. superior
0.076mm - 0.003"	30/42-6A (31431401, 736812M1)	30/42-9A (31431316, 3638919M91)	30/43-6A (31431882, 741937M1)	30/43-9A (3142A053, 747553M1)
0.38mm - 0.015"	30/42-6B (31431402, 736813M1)	30/42-9B (31431317, 3641297M1)	30/43-6B (31431883, 741938M1)	30/43-9B (3142A054, 747554M1)
0.76mm - 0.030"	30/42-6C (31431403, 736814M1)	30/42-9C (31431318, 3638920M91)	30/43-6C (31431884, 741939M1)	30/43-9C (3142A055, 747555M1)

Part numbers are quoted for reference purposes only.
Our parts and accessories are not original.

*Las referencias originales tienen un propósito identificativo.
Nuestras piezas no son originales.*



ROCKER SHAFTS & ARMS
BALANCINES



Tractors <i>Tractores</i>	Engine <i>Motor</i>	1	2	3	4	5	6
		Rocker shaft <i>Eje de balancín</i>	Rocker arm / <i>Balancín</i>		Rocker arm bush <i>Casquillo de balancín</i>	Push rod <i>Empujador</i>	Tappet <i>Tápet</i>
		LH / <i>Dcho.</i>	RH / <i>Izdo.</i>				
3 cylinder engines / Motores 3 cilindros							
35, 133, 135	A3.144						
35	A3.152						
135	AG3.152						
133, 134, 135, 140, 145, 148, 150, 152, 154, 230, 233, 234, 235, 240, 244CF, 245, 250, 253 (Italy), 254, 255, 333, 334V, 340, 342, 350, 353, 354, 356CF, 550, 2205, 3210	AD3.152	30/6051-1 (ZZ90047, 3637532M91)	30/50-4 (3737A101, 3638185M1)	30/50-5 (3737A091, 3638184M1)			30/54-2 (0860012, 731150M1)
164T, 253 (UK), 263T (Italy), 264T, 352, 355, 360, 363, 364, 366CF	AT3.152.4						
4 cylinder engines / Motores 4 cilindros							
65	A4.192						
65, 865	A4.203		30/50-4 (3737A101, 3638185M1)	30/50-5 (3737A091, 3638184M1)			30/54-2 (0860012, 731150M1)
65, 155, 158, 158MKIII, 165, 260, 560, 765	AD4.203						
165, 174	A4.212						
168, 168MKIII, 174, 175, 184, 255 (USA), 265, 273, 274, 275, 275E, 283, 284, 362, 362N, 365, 367CF, 372N, 373, 374, 375, 375E, 376C, 377, 383, 384, 387, 565, 575, 675, 3050, 3220, 3225	A4.236						
390T, 393TLX, 394TAQ, 396CT, 397T, 398, 698T, 1004T, 1007, 3065, 3065S, 3070	AT4.236	30/6051-2 (ZZ90032, 3637395M91)	30/50-6 (4115R306, 4223076M91)	30/50-7 (4115R305, 4223075M91)	30/6052-1 (A) (2511425, 895748M1)	30/53-2 (31434307, 733817M1)	30/54-3 (3142U031, 4222069M1)
178, 185, 188, 194, 285, 290, 290E, 293, 294, 382N, 390, 390E, 393, 394, 396C, 397T, 590, 690, 3055, 3060, 3235	A4.248						
275E, 290E, 375E, 390E, 4225, 4235, 4240, 6110, 6120	A4.41 (Blue)						
3075, 4245, 4255, 6130, 6140, 6150	1004.4T (Blue)						

(A) 30/6052-1 bush is used with rocker arms starting with Perkins reference 41151. eg 41151419, 41151421, 41151467, 41151468, 41151481, 41151482, 41151483, 41151484. It is not required for rocker arms starting with Perkins reference 3737 or 4115R.

(A) El casquillo 30/6052-1 se usa con los balancines cuya referencia de Perkins comienza por 41151... por ejemplo: 41151419, 41151421, 41151467, 41151468, 41151481, 41151482, 41151483, 41151484. El casquillo no es necesario para balancines cuya referencia Perkins comienza por 3737 o 4115.

Part numbers are quoted for reference purposes only.
Our parts and accessories are not original.

Las referencias originales tienen un símbolo identificativo.
Nuestras piezas no son originales.



**ROCKER SHAFTS & ARMS
BALANCIENES**



Tractor Tractor	Engine Motor	1	2		3	4	5	6
		Rocker shaft Eje de balancín	Rocker arm / Balancín		Rocker arm bush Casquillo de balancín	Push rod Empujado	Tappet Táquet	
		LH / Dcho.	RH / Izdo.					
4 cylinder engines / Motores 4 cilindros								
374, 3220, 3330, 4225, 4325	1004.40 (Green)							
3350, 3355, 4235, 4245, 4255, 4345, 4355, 6235, 6245, 6255	1004.40T (Green)						30/53-2 (31434307, 733817M1)	30/54-3 (3142U031, 4222069M1)
4265, 4365, 6265	1004.40TW (Green)							
394, 2230, 3235, 3340, 4235 (USA), 4335	1004.42 (Green)							
6 cylinder engines / Motores 6 cilindros								
1100	A6.354							
1014, 1104, 1200	A6.354.1							
399, 699, 1014, 1024, 1114, 1250, 2620, 2625, 2640, 2645, 2675, 3080, 3090, 3610	A6.354.4							
1105 1130 1135	AT6.354.1 AT6.354 AT6.354.1		30/50-6 (4115R306, 4223076M91)	30/50-7 (4115R305, 4223075M91)	30/6052-1 (A) (2511425, 895748M1)		30/53-2 (31434307, 733817M1)	30/54-3 (3142U031, 4222069M1)
1134, 2680, 2685, 2705, 2720, 2725, 3630, 3650	AT6.354.4							
396, 399, 3085, 3095, 3115, 4260, 4270, 6160, 6170	1006.6 (Blue)							
3120, 3120T, 3125, 3140, 3635, 3645, 3655, 3660, 6180, 6190, 8110, 8120, 8130	1006.6T (Blue)							
4260, 4360, 6260	1006.60 (Green)							
4270, 4370, 6170, 6180, 6270, 6280, 6290, 8120, 8210, 8220	1006.60T (Green)							

(A) 30/6052-1 bush is used with rocker arms starting with Perkins reference 41151... eg 41151419, 41151421, 41151467, 41151468, 41151481, 41151482, 41151483, 41151484. It is not required for rocker arms starting with Perkins reference 3737 or 4115R.

(A) El casquillo 30/6052-1 se usa con los balancines cuya referencia de Perkins comienza por 41151..., por ejemplo: 41151419, 41151421, 41151467, 41151468, 41151481, 41151482, 41151483, 41151484. El casquillo no es necesario para balancines cuya referencia Perkins comienza por 3737 o 4115.

Part numbers are quoted for reference purposes only.
Our parts and accessories are not original.

Las referencias originales tienen un propósito identificativo.
Nuestras piezas no son originales.



ROCKER SHAFTS & ARMS
BALANCINES



Tractors <i>Tractores</i>	Engine <i>Motor</i>	1 Rocker shaft <i>Eje de balancín</i>	2 Rocker arm / <i>Balancín</i>		4 Rocker arm bush <i>Casquillo de balancín</i>	5 Push rod <i>Empujado</i>	6 Tappet <i>Taquet</i>
			LH / <i>Dcho.</i>	RH / <i>Izdo.</i>			
4 cylinder engines combines / Cosechadoras motores 4 cilindros							
186	A4.212						
8 Plot, 10 Plot, 16 Plot, 16, 99, 187, 206, 240, 307, 330	A4.236	30/6051-2 (ZZ90032, 3637395M91)	30/50-6 (4115R306, 4223076M91)	30/50-7 (4115R305, 4223075M91)	30/6052-1 (A) (2511425, 895748M1)	30/53-2 (31434307, 733817M1)	30/54-3 (3142U031, 4222069M1)
20XP	AT4.236						
20, 430, 440, 487, 506	A4.248						
6 cylinder engines combines / Cosechadoras motores 6 cilindros							
500, 507, 510, 515, 520, 525	A6.354						
24, 27, 530, 530S, 535, 800, 805, 810, 815	A6.354.4						
750, 760	AT6.354.1		30/50-6 (4115R306, 4223076M91)	30/50-7 (4115R305, 4223075M91)	30/6052-1 (A) (2511425, 895748M1)	30/53-2 (31434307, 733817M1)	30/54-3 (3142U031, 4222069M1)
29, 29XP, 31, 31XP, 560, 565, 660, 665, 750, 760, 820, 825, 830, 835, 840, 845, 850, 855, 860	AT6.354.4						
620, 625, 740, 750	A6.372						
750	A6.372.4						
Telescopic handlers / Carretillas elevadoras telescópicas							
24	A4.236						
24T	AT4.236	30/6051-2 (ZZ90032, 3637395M91)	30/50-6 (4115R306, 4223076M91)	30/50-7 (4115R305, 4223075M91)	30/6052-1 (A) (2511425, 895748M1)	30/53-2 (31434307, 733817M1)	30/54-3 (3142U031, 4222069M1)
8925, 8926, 8937, 8939	1004.4 (Blue)						
8925T, 8926T, 8937T, 8939T	1004.4T (Blue)						
8925, 8926, 8937, 8939	1004.42 (Green)						
8925T, 8926T, 8937T, 8939T	1004.40T (Green)						

(A) 30/6052-1 bush is used with rocker arms starting with Perkins reference 41151... eg 41151419, 41151421, 41151467, 41151468, 41151481, 41151482, 41151483, 41151484. It is not required for rocker arms starting with Perkins reference 3737 or 4115R.

(A) El casquillo 30/6052-1 se usa con los balancines cuya referencia de Perkins comienza por 41151..., por ejemplo: 41151419, 41151421, 41151467, 41151468, 41151481, 41151482, 41151483, 41151484. El casquillo no es necesario para balancines cuya referencia Perkins comienza por 3737 o 4115R.

Part numbers are quoted for reference purposes only.
Our parts and accessories are not original.

Las referencias originales tienen un prototipo identificativo.
Nuestras piezas no son originales.



**ROCKER SHAFTS & ARMS
BALANCINES**



Tractors Tractores	Engine Motor	1 Rocker shaft Eje de balancín	2 Rocker arm / Balancín		4 Rocker arm bush Casquillo de balancín	5 Push rod Empujado	6 Tappet Táquet
			LH / Dcho.	RH / Izdo.			
3 cylinder engine industrial tractors / Palas retrocargadoras motores 3 cilindros							
203, 205	A3.152	30/6051-1 (ZZ90047, 3637532M91)	30/50-4 (3737A101, 3638185M1)	30/50-5 (3737A091, 3638184M1)			30/54-2 (0860012, 731150M1)
20, 40	AG3.152						
20, 20B, 20C, 20D, 20E, 20F, 30B, 30E, 30H, 40, 203, 205, 2135, 2203, 2205	AD3.152						
40E	AT3.152-4						
4 cylinder engine industrial tractors / Palas retrocargadoras motores 4 cilindros							
356	A4.203	30/6051-2 (ZZ90032, 3637395M91)	30/50-6 (4115R306, 4223076M91)	30/50-7 (4115R305, 4223075M91)	30/6052-1 (A) (2511425, 895748M1)	30/53-2 (31434307, 733817M1)	30/54-3 (3142U031, 4222069M1)
30, 40B, 50, 302, 304, 356, 3165, 3303, 3305	AD4.203						
50, 50B, 3303, 3305	A4.212						
30D, 50, 50B, 50B MKII, 50C, 50D, 50E, 50H, 50H-S, 50H-T, 60	A4.236	30/6051-2 (ZZ90032, 3637395M91)	30/50-6 (4115R306, 4223076M91)	30/50-7 (4115R305, 4223075M91)	30/6052-1 (A) (2511425, 895748M1)	30/53-2 (31434307, 733817M1)	30/54-3 (3142U031, 4222069M1)
60HX, 60HX-T	AT4.236						
50EX, 50HX, 50HX-S, 50HX-T, 60H, 60H-S	A4.248						
Permec & 4 cylinder engine industrial tractors / Palas retrocargadoras motores 4 cilindros							
750	1004.4 (Blue)	30/6051-2 (ZZ90032, 3637395M91)	30/50-6 (4115R306, 4223076M91)	30/50-7 (4115R305, 4223075M91)	30/6052-1 (A) (2511425, 895748M1)	30/53-2 (31434307, 733817M1)	30/54-3 (3142U031, 4222069M1)
760, 860, 860S, 860SE, 865, 960, 965	1004.4T (Blue)						
750, 750B	1004.42 (Green)						
760, 760B, 860, 860B, 860S, 860SE, 960, 960B, 965	1004.40T (Green)						

(A) 30/6052-1 bush is used with rocker arms starting with Perkins reference 41151... eg 41151419, 41151421, 41151467, 41151468, 41151481, 41151482, 41151483, 41151484. It is not required for rocker arms starting with Perkins reference 3737 or 4115R.

(A) El casquillo 30/6052-1 se usa con los balancines cuya referencia de Perkins comienza por 41151..., por ejemplo: 41151419, 41151421, 41151467, 41151468, 41151481, 41151482, 41151483, 41151484. El casquillo no es necesario para balancines cuya referencia Perkins comienza por 3737 o 4115.

Part numbers are quoted for reference purposes only.
Our parts and accessories are not original.

Las referencias originales tienen un propósito identificativo.
Nuestras piezas no son originales.



ENGINE GASKET SETS
JUNTAS DE MOTOR

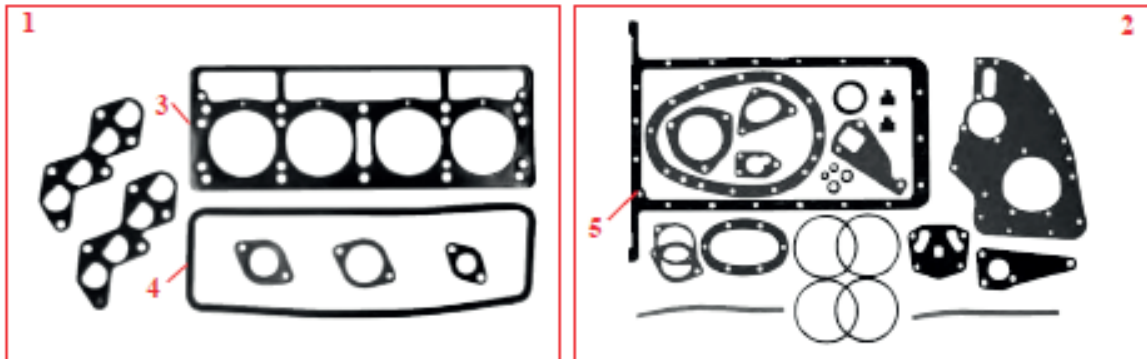

Tractors <i>Tractores</i>	Engine <i>Motor</i>	1 Top gasket set <i>Juego de jun. sup.</i>	2 Bottom gasket set <i>Juego de jun. inf.</i>	3 Cyl. head gasket <i>Junta culata</i>	4 Rocker cover gasket <i>Junta tapa de balacín</i>	5 Sump gasket <i>Junta de cárter</i>
3 cylinder engines / Motores 3 cilindros						
35	A3.144	30/71-3 (U5LT0512, 4222562M91)		30/73-3 (36812142, 4223582M1)	30/74-5 (0490491, 731273M1)	30/75-4 (D) (U5LB0501, 4223524M91)
133, 135	A3.144	30/71-107 (U5LT0511, 4223532M91)				
135	AG3.152	30/71-9 (U5LT0537, 4223123M91)	30/72-5 (B) (U5LB1157, 4224142M91)			
133, 134, 135, 140, 145, 148, 150, 152, 154, 230, 233, 234, 235, 240, 244CF, 245, 250, 253 (Italy), 254, 255, 333, 334V, 340, 342, 350, 353, 354, 356CF, 550, 3210	AD3.152	30/71-5 (A) (U5LT1138, U5LT5138, 4223922M91, 4223923M91)		30/73-4 (C) (3681E024, 3641399M1)	30/74-8 (36811115, 735057M1)	
2205	AD3.152		30/72-107 (U5LB1110, 4224032M91)			
164T, 253 (UK), 263T (Italy), 264T, 352, 355, 360, 363, 364, 366CF	AT3.152.4	30/71-5 (A) (U5LT1139, U5LT5138, 4223921M91, 4223923M91)	30/72-5 (U5LB1157, 4224142M91)			30/75-105 (D) (21826370, 21826397, 4224249M91, 4224458M1)
2210	903.27		30/72-107 (U5LB1110, 4224032M91)			
3315, 4215, 4315		30/71-81 (U5LT0216, U5LT0217, 4224027M91, 4222759M91)	30/72-105 (U5LB0304, 4222760M91)	30/73-107 (3681E028, 4222588M1)	30/74-107 (3681A033, 4222648M1)	
263 (UK)			30/72-107 (U5LB1110, 4224032M91)			
2220	903.27T					
3325, 4220, 4320			30/72-105 (U5LB0304, 4222760M91)			

(A) Suitable for both normally aspirated & turbo charged engines / *Adaptable a motores atmosféricos y turbo*

(B) Suitable for both rope seal & lip seal blocks / *Adaptable a bloques con retén trasero de cuerdas y de labios*

(C) Copper gasket alternative available 30/73-4A (36812127, 735018M2) / *Disponible en versión cobre 30/73-4A (36812127, 735018M2)*

(D) Sump gasket is supplied complete with front & rear cork joints / *La junta de cárter se sirve con las juntas de corcho delantera y trasera.*

Part numbers are quoted for reference purposes only.
Our parts and accessories are not original.

Las referencias originales tienen un símbolo identificativo.
Nuestras piezas no son originales.



ENGINE GASKET SETS
JUNTAS DE MOTOR

Tractores Tractors	Engine Motor	1 Top gasket set Juego de jun. sup.	2 Bottom gasket set Juego de jun. inf.	3 Cyl head gasket Junta culata	4 Rocker cover gasket Junta tapa de balacin	5 Sump gasket Junta de cárter
4 cylinder engines / Motores 4 cilindros						
TEA TED TEH	85mm Petrol 85mm VO 85mmLO	30/71-19 (3901525M91)	30/72-19 (894915M91)	30/73-19 (202084)	30/74-1 (829029M1)	30/75-120 (3910267M1)
TEF	20C Diesel	30/71-1 (106387)	30/72-1 (894916M91)	30/73-1 (61153)	30/74-2 (61396)	
FE35 (⇒ SJ41889E), 835	23C Diesel	30/71-2 (1810028M91)	30/72-2 (1810027M91)	30/73-2 (1882771M1)	30/74-3 (828695M1)	30/75-111 (3910274M1)
FE35 (SJ41890E ⇒)	23C Diesel				30/74-4 (826194M1)	
35, 135	87mm Petrol	30/71-20 (827560M1)	30/72-20 (894902M91)	30/73-20 (826250M1)	30/74-1 (829029M1)	30/75-120 (3910267M1)
25, 122	A4.99	30/71-30 (U5LT0523, 4222808M91)	30/72-30 (U5LB1116, 4223920M91)	30/73-30 (36812143, 4223784M1)	30/74-7 (0490724, 732117M1)	30/75-107 (D) (36815386, 4222556M91)
25, 30, 130, 825	A4.107					
65	A4.192	30/71-6 (69035, 746050M91)	30/72-6 (U5LB0502, 4223525M91)	30/73-6 (0490689, 3639160M1)	30/74-6 (0490704, 731164M1)	30/75-108 (E) (41424238, 4224063M91)
65, 865	A4.203	30/71-7 (U5LT0509, 4222455M91)		30/73-7 (36812141, 4222122M1)		
65, 155, 158, 165, 765 (⇒ 29C1083) Rope seal / Retén de cuerdas	AD4.203	30/71-8 (U5LT0100, 4222920M91)	30/72-9 (U5LB1117, 4223940M91)	30/73-8 (3681E023, 3641182M1)	30/74-9 (36811112, 732821M1)	30/75-109 (E) (41424239, 21826401, 4222934M1, 4224379M1)
65, 155, 158, 165, 765 (29C1084 ⇒) Lip seal / Retén de labios	AD4.203					
158 MKIII, 260, 560	AD4.203	30/71-108 (U5LT0383, 4224307M91)				
165, 174	A4.212					
168, 174, 175, 184, 255 (USA), 265, 273, 274, 275, 283, 284, 565, 575, 675, 3050 Early blocks 103.19mm bore Ø Primeros bloques 103.19mm dia. Ø	A4.236	30/71-10 (U5LT1014, 4224186M91)		30/73-11 (3681E021, 3638845M1)		
168, 174, 184, 255 (USA), 265, 273, 274, 275, 283, 284, 565, 575, 675, 3050 Later blocks 104.20mm bore Ø Últimos bloques 104.20mm dia. Ø	A4.236			(⇒ 04/03/95) 30/73-52 (3681E036, 4222500M1)	30/74-11 (3681A027, 21826363, 3638482M1, 4223924M1)	30/75-106 (3681K003, 3641273M1)
168MKIII, 275E, 362, 362N, 365, 367CF, 372N, 373, 374, 375, 375E, 376C, 377, 383, 384, 387, 3220, 3225	A4.236	30/71-52 (U5LT1004, 4224189M91)	30/72-10 (U5LB1158, 4224369M1)	(05/03/95 ⇒) 30/73-53 (3681E034, 4222124M1)		
275E, 375E	A4.236					
698T, 1004T Early blocks 103.19mm bore Ø Primeros bloques 103.19mm dia. Ø	AT4.236	30/71-10 (U5LT1014, 4224186M91)		30/73-11 (3681E021, 3638845M1)		
698T, 1004T Later blocks 104.20mm bore Ø Últimos bloques 104.20mm dia. Ø	AT4.236	30/71-53 (U5LT1006, 4224246M91)		30/73-53 (3681E034, 4222124M1)		
390T, 393TLX, 394TAQ, 396CT, 397T, 398, 1007, 3065, 3065S, 3070	AT4.236					

(D) Sump gasket is supplied complete with front & rear cork joints / La junta de cárter se sirve con las juntas de corcho delantera y trasera.
(E) Sump gasket is supplied complete with rear cork joint / La junta de cárter se sirve con la junta de corcho trasera.

Part numbers are quoted for reference purposes only.
Our parts and accessories are not original.

Las referencias originales tienen un propósito identificativo.
Nuestras piezas no son originales.



ENGINE GASKET SETS
JUNTAS DE MOTOR

Tractors <i>Tractores:</i>	Engine <i>Motor</i>	1 <i>Top gasket set Juego de jun. sup.</i>	2 <i>Bottom gasket set Juego de jun. inf.</i>	3 <i>Cyl head gasket Juntas culata</i>	4 <i>Rocker cover gasket Junta tapa de balacin</i>	5 <i>Sump gasket Junta de cárter</i>
4 cylinder engines / Motores 4 cilindros						
178, 185, 188	A4.248	30/71-10 (U5LT1014, 4224186M91)	30/72-10 (U5LB0145, 3640719M91)	30/73-11 (3681E021, 3638845M1)		
194, 285, 290, 293, 294, 590, 690 <i>With flame ring Con segmentos cortafuegos</i>	A4.248				30/74-11 (3681A027, 21826363, 3638482M1, 4223924M1)	30/75-106 (3681K003, 3641273M1)
194, 290, 293, 294, 690 <i>Without flame ring Sin segmentos cortafuegos</i>	A4.248			(⇒ 04/03/95) 30/73-52 (3681E036, 4222500M1)		
290E, 390E	A4.248	30/71-52 (U5LT1004, 4224189M91)	30/72-51 (U5LB1158, 4224369M1)	(05/03/95 ⇒) 30/73-53 (3681E034, 4222124M1)		
382N, 390, 393, 394, 396C, 397, 3055, 3060, 3235	A4.248		30/72-10 (U5LB0145, 3640719M91)			
285 (USA), 592, 595, 1080, 1085	A4.318	30/71-31 (U5LT0520, 4223502M91)	30/72-31 (U5LB0221, 4223129M91)	30/73-31 (36812348, 745730M1)	30/74-13 (3681A008, 746036M1)	30/75-121 (21826314, 4223002M1)
285 (USA), 298, 592, 595, 698, 1004	A4.318.2					
275E, 290E, 375E, 390E	A4.41 (Blue)		30/72-113 (U5LB1160, 4224457M91)		Cork / Corcho	
4225 (LM31290)	A4.41 (Blue)	30/71-90 (F) (U5LT0215, U5LT0314, U5LT1178, U5LT1196, 4223130M91, 4223573M91, 4224621M91, 4224623M91)	30/72-10 (U5LB0145, 3640719M91)		30/74-90 (3681A021, 3640094M1)	
4225 (LM31320)	A4.41 (Blue)					
4225 (LM31378, LM31379)	A4.41 (Blue)			30/73-90 (3681E037, 4224501M1)	Plastic / Plástico	30/75-106 (3681K003, 3681K005, 3641273M1, 3640406M1)
4225HV (LM31380, LM31381)	A4.41 (Blue)					
4235, 4235HV	A4.41					
6110, 6120	A4.41		30/72-113 (U5LB0146, U5LB1160, 3641075M91, 4224457M91)		30/74-105 (3681A032, 3641891M1)	
3075, 6130, 6140, 6150	1004.4T					
4245, 4255	1004.4T (Blue)					
374, 3220, 3330	1004.40 (Green)	30/71-82 (F) (U5LT0327, U5LT1202, 4224346M91, 4224635M91)			30/74-108 (3681A049, 4224452M91)	
4225, 4325	1004.40 (Green)		30/72-114 (U5LB1319, 4224699M91)			

(F) Comprehensive set fitting all mentioned applications / Juego Universal para montaje sobre todas las aplicaciones mencionadas

Part numbers are quoted for reference purposes only.
Our parts and accessories are not original.

Las referencias originales tienen un prepósito identificativo.
Nuestras piezas no son originales.



ENGINE GASKET SETS
JUNTAS DE MOTOR



		1	2	3	4	5
Tractors <i>Tractores</i>	Engine <i>Motor</i>	Top gasket set <i>Juego de jua. sup.</i>	Bottom gasket set <i>Juego de jua. inf.</i>	Cyl head gasket <i>Junta culata</i>	Rocker cover gasket <i>Junta tapa de balancin</i>	Sump gasket <i>Junta de cárter</i>
4 cylinder engines / Motores 4 cilindros						
3350, 3355	1004.40T (Green)					
4235, 4245, 4255, 4345, 4355, 6235, 6245, 6255	1004.40T (Green)	30/71-82 (U5LT1202, 4224635M91)	30/72-114 (U5LB1319, 4224699M91)	30/73-90 (3681E037, 4224501M1)	30/74-108 (3681A049, 4224452M91)	30/75-106 (3681K003, 3641273M1)
4265, 4365, 6265	1004.40TW					
394, 2230, 3235, 3340	1004.42 (Green)	30/71-83 (U5LT0317, 4223451M91)	30/72-113 (U5LB1160, 4224457M91)	30/73-83 (3681E042, 4223146M1)		
4235 (USA), 4335	1004.42 (Green)					
6 cylinder engines / Motores 6 cilindros						
1100	A6.354	30/71-12 (U5LT1181, 4224167M91)	30/72-12 (U5LB1224, 4224120M91)	30/73-12 (36812546, 740377M1)	30/74-15 (36811412, 733834M1)	
1014, 1104	A6.354.1			30/73-35 (36812547, 740376M1)		
1200	A6.354.1	30/71-35 (U5LT1186, 4224152M91)			30/74-17 (36811451, 4222942M1)	
399, 699, 1014, 1024, 1114 2620, 2640 (S271213 ⇔) 2625, 2645, 2675, 3080, 3090, 3610	A6.354.4	30/71-59 (U5LT1190, 4224053M91)	30/72-57 (U5LB1225, 4224049M91)	30/73-56 (3681H202, 3638305M1)	30/74-32 (21826362, 4223925M1)	30/75-110 (U5MK0398, 36816733, 4224291M1, 4224116M1)
1250 2620, 2640 (⇔ S271212)	A6.354.4					
Motors turbo standard <i>Standard turbo applications</i>	AT6.354	30/71-34 (U5LT0025, 3639445M1)		30/73-12 (36812546, 740377M1)	30/74-15 (36811412, 733834M1)	
1105 1130 1135	ATC6.354.1 AT6.354 AT6.354.1	30/71-35 (U5LT1186, 4224152M91)	30/72-12 (U5LB1224, 4224120M91)	30/73-35 (36812547, 740376M1)	30/74-17 (36811451, 4222942M1)	
1134, 2680 (S271213 ⇔) 2705, 3630, 2685, 2720, 2725, 3650	AT6.354.4	30/71-59 (U5LT1190, 4224053M91)	30/72-57 (U5LB1225, 4224049M91)	30/73-56 (3681H202, 3638305M1)	30/74-32 (21826362, 4223925M1)	
2680 (⇔ S271212)	AT6.354.4					

Part numbers are quoted for reference purposes only.
Our parts and accessories are not original.

Las referencias originales tienen un propósito identificativo.
Nuestras piezas no son originales.



ENGINE GASKET SETS
JUNTAS DE MOTOR

		1	2	3	4	5
Tractors Tractores	Engine Motor	Top gasket set Juego de jun. sup.	Bottom gasket set Juego de jun. inf.	Cyl. head gasket Juntas culata	Rocker cover gasket Juntas tapa de balacin	Sump gasket Juntas de cárter
6 cylinder engines / Motores 6 cilindros						
396, 399	1006.6				Type / Tipo A  30/74-91 (3681C001, 748329M1)	
3085, 3095, 3115, 6160, 6170	1006.6 (Blue)	30/71-91 (U5LT0179, 3638697M91)			Type / Tipo B  30/74-109 (3681C003, 3641821M1)	
3120, 3120T, 3125, 3140, 3635, 3645, 3655, 3660, 6180, 6190, 8110, 8120, 8130	1006.6T (Blue)		30/72-91 (F) (U5LB1167, U5LB1168, 4224613M91, 4224611M91)	30/73-91 (3681H208, 4222354M1)		30/75-113 (3681M005, 3638562M1)
4260, 4270	1006.6 (Blue)	30/71-109 (U5LT0309, 4223114M91)			30/74-109 (3681C003, 3641821M1)	
4260, 4360	1006.60 (Green)	30/71-115 (F) (U5LT0300, U5LT0301, U5LT1300, U5LT1309, 4222468M91, 4223732M91, 4224667M91, 4224668M91)				
4270, 4370, 6170, 6180, 8120	1006.60T (Green)					
6260	1006.60		30/72-106 (F) (U5LB0308, U5LB1331, 4224476M91, 4224674M91)		30/74-106 (3681A051, 4224398M1)	
6270, 6280, 6290 8210, 8220	1006.60T					

(F) Comprehensive set fitting all mentioned applications / Juego Universal para montaje sobre todas las aplicaciones mencionadas

Part numbers are quoted for reference purposes only.
Our parts and accessories are not original.

Las referencias originales tienen un propósito identificativo.
Nuestras piezas no son originales.



ENGINE GASKET SETS
JUNTAS DE MOTOR

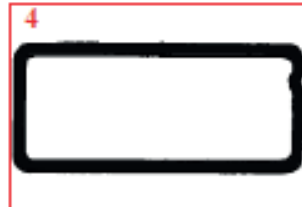
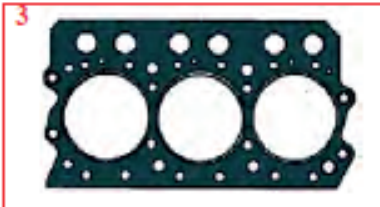

		3	4	5
Tractors <i>Tractores</i>	Engine <i>Motor</i>	Cyl head gasket <i>Junta culata</i>	Rocker cover gasket <i>Junta tapa de balancin</i>	Sump gasket <i>Junta de cárter</i>
6 cylinder engines / Motores 6 cilindros				
3680, 3690	612DS	30/73-122 (V836122443, 3637639M1)	30/74-122 (V836322898, 3637643M1)	
3670, 8140, 8150	620DS			
8240	620DSRAE			
8240Xtra	620DWBAE			
3690, 8160	634DS			30/75-122 (V836322183, 3638939M1)
8250, 8260	634DSBAE	30/73-123 (V836664155, 3638960M1)	30/74-123 (V836646360, 3638963M1)	
8260	634DSBIE			
8250Xtra, 8260Xtra	634DWBAE			
8170, 8180, 8270, 8280	645DSBIE			
8270Xtra, 8280Xtra	645DSBAE			

Part numbers are quoted for reference purposes only.
Our parts and accessories are not original.

Las referencias originales tienen un propósito identificativo.
Nuestras piezas no son originales.



ENGINE GASKET SETS
JUNTAS DE MOTOR

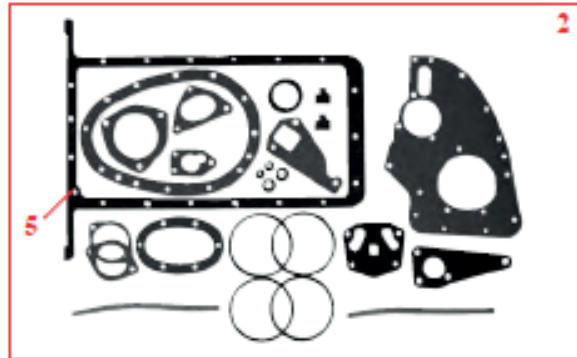
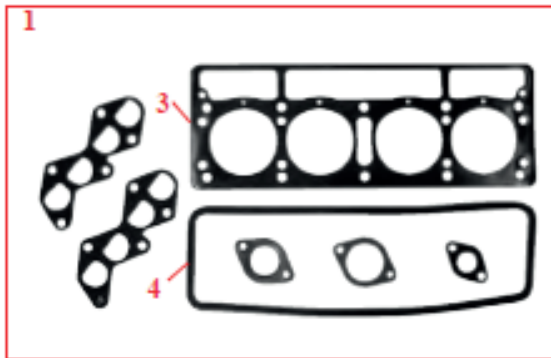

Tractors Tractores	Engine Motor	1 Top gasket set Juego de jun. sup.	2 Bottom gasket set Juego de jun. inf.	3 Cyl head gasket Junta culata	4 Rocker cover gasket Junta tapa de balancin	5 Sump gasket Junta de carter
4 cylinder engines combines / Cosechadoras motores 4 cilindros						
186	A4.212					
8 Plot, 10 Plot, 16 Plot, 16, 99, 187, 206, 240, 307, 330	A4.236	30/71-10 (U5LT1014, 4224186M91)		30/73-11 (3681E021, 3638845M1)		
20XP (⇔ U027773M) Early blocks 103.19mm bore Ø Primeros bloques 103.19mm dia.	AT4.236					
20XP (U027774M ⇔) Later blocks 104.20mm bore Ø Últimos bloques 104.20mm dia. Ø	AT4.236	30/71-53 (U5LT1006, 4224246M91)	30/72-113 (U5LB0146, U5LB1160, 3641075M91, 4224457M91)	30/73-53 (3681E034, 4222124M1)	30/74-11 (3681A027, 3638482M1)	30/75-106 (3681K005, 3640406M1)
430, 440, 487, 506	A4.248	30/71-10 (U5LT1014, 4224186M91)		30/73-11 (3681E021, 3638845M1)		
20 (⇔ U108196N) With flame ring Con segmentos cortifuegos	A4.248					
20 (U108197N ⇔) Without flame ring Sin segmentos cortifuegos	A4.248	30/71-52 (U5LT1004, 4224189M91)		30/73-52 (3681E036, 4222500M1)		
6 cylinder engines combines / Cosechadoras motores 6 cilindros						
500, 507, 510, 515, 520, 525	A6.354	30/71-12 (U5LT1181, 4224167M91)	30/72-12 (U5LB1224, 4224120M91)	30/73-12 (36812546, 740377M1)	30/74-15 (36811412, 733834M1)	
24, 27, 530, 530S, 535, 800, 805, 810, 815	A6.354.4	30/71-59 (U5LT1190, 4224053M91)	30/72-57 (U5LB1225, 4224049M91)	30/73-56 (3681H202, 3638305M1)	30/74-32 (21826362, 4223925M1)	
750, 760	AT6.354.1	30/71-35 (U5LT1186, 4224152M91)	30/72-12 (U5LB1224, 4224120M91)	30/73-35 (36812547, 740376M1)	30/74-17 (36811451, 4222942M1)	
29, 29XP, 31, 560, 565, 660, 665, 750, 760, 820, 825, 830, 835, 840, 845, 850, 855, 860	AT6.354.4	30/71-59 (U5LT1190, U5LT1192, 4224053M91, 4224090M91)	30/72-57 (U5LB1225, 4224049M91)	30/73-56 (3681H202, 3638305M1)	30/74-32 (21826362, 4223925M1)	30/75-110 (U5MK0398, 4224291M1)
31XP	AT6.354.4					
620, 625	A6.372		30/72-12 (U5LB1224, 4224120M91)	30/73-35 (36812547, 740376M1)	30/74-15 (36811412, 733834M1)	
740, 750	A6.372	30/71-35 (U5LT1186, 4224152M91)			30/74-17 (36811451, 4222942M1)	
750	A6.372.4		30/72-57 (U5LB1225, 4224049M91)		30/74-32 (21826362, 4223925M1)	

Part numbers are quoted for reference purposes only.
Our parts and accessories are not original.

Las referencias originales tienen un propósito identificativo.
Nuestras piezas no son originales.



ENGINE GASKET SETS
JUNTAS DE MOTOR

		1	2	3	4	5
Tractors Tractores	Engine Motor	Top gasket set Juego de jun. sup.	Bottom gasket set Juego de jun. inf.	Cyl head gasket Juntas culata	Rocker cover gasket Junta tapa de balancín	Sump gasket Junta de cárter
Telescopic handlers / Carretillas elevadoras telescópicas						
24	A4.236	30/71-52 (U5LT1004, 4224189M91)	30/72-10 (U5LB0145, 3640719M91)	30/73-52 (3681E036, 4222500M1)	30/74-11 (3681A027, 3638482M1)	
24T	AT4.236	30/71-53 (U5LT1006, 4224246M91)		30/73-53 (3681E034, 4222124M1)		
8925, 8926, 8937, 8939	1004.4 (Blue)	30/71-90 (F) (U5LT1178, U5LT1196, 4224621M91, 4224623M91)	30/72-90 (U5LB1164, 4224595M91)	30/73-90 (3681E037, 4224501M1)	30/74-105 (3681A032, 3641891M1)	30/75-106 (3681E003, 3681E005, 3641273M1, 3640406M1)
8925T, 8926T, 8937T, 8939T	1004.4T (Blue)					
8925, 8926, 8937, 8939	1004.42 (Green)	30/71-83 (U5LT0317, 4223451M91)		30/73-83 (3681E042, 4223146M1)		
8925T, 8926T, 8937T, 8939T	1004.40T (Green)	30/71-82 (U5LT1202, 4224635M91)		30/73-90 (3681E037, 4224501M1)	30/74-108 (3681A049, 4224452M91)	
3 cylinder engine industrial tractors / Palas retrocargadoras motores 3 cilindros						
203, 205	A3.152	30/71-3 (U5LT0512, 4222562M91)		30/73-3 (36812142, 4223582M1)	30/74-5 (0490491, 731273M1)	30/75-4 (D) (U5LB0501, 4223524M91)
20, 40	AG3.152	30/71-9 (U5LT0537, 4223123M91)				
20, 20B, 20C, 20D, 20E, 20F, 30B, 30E, 30H, 40, 203, 205, 2135, 2203, 2205	AD3.152	30/71-5 (A) (U5LT1138, U5LT5138, 4223922M91, 4223923M91)	30/72-5 (B) (U5LB1157, 4224142M91)	30/73-4 (C) (3681E024, 3641399M1)	30/74-8 (36811115, 735057M1)	30/75-105 (D) (21826370, 4224249M91)
40E	AT3.152.4	30/71-5 (A) (U5LT1139, 4223921M91)				

(A) Suitable for both normally aspirated & turbo charged engines / Adaptable a motores atmosféricos y turbo

(B) Suitable for both rope seal & lip seal blocks / Adaptable a bloques con resín trasero de cuerdas y de labios

(C) Copper gasket alternative available 30/73-4A (36812127, 735018M2) / Disponible en versión cobre 30/73-4A (36812127, 735018M2)

(D) Sump gasket is supplied complete with front & rear cork joints / La junta de cárter se sirve con las juntas de corcho delantera y trasera.

Part numbers are quoted for reference purposes only.
Our parts and accessories are not original.

Las referencias originales tienen un propósito identificativo.
Nuestras piezas no son originales.